

ARP

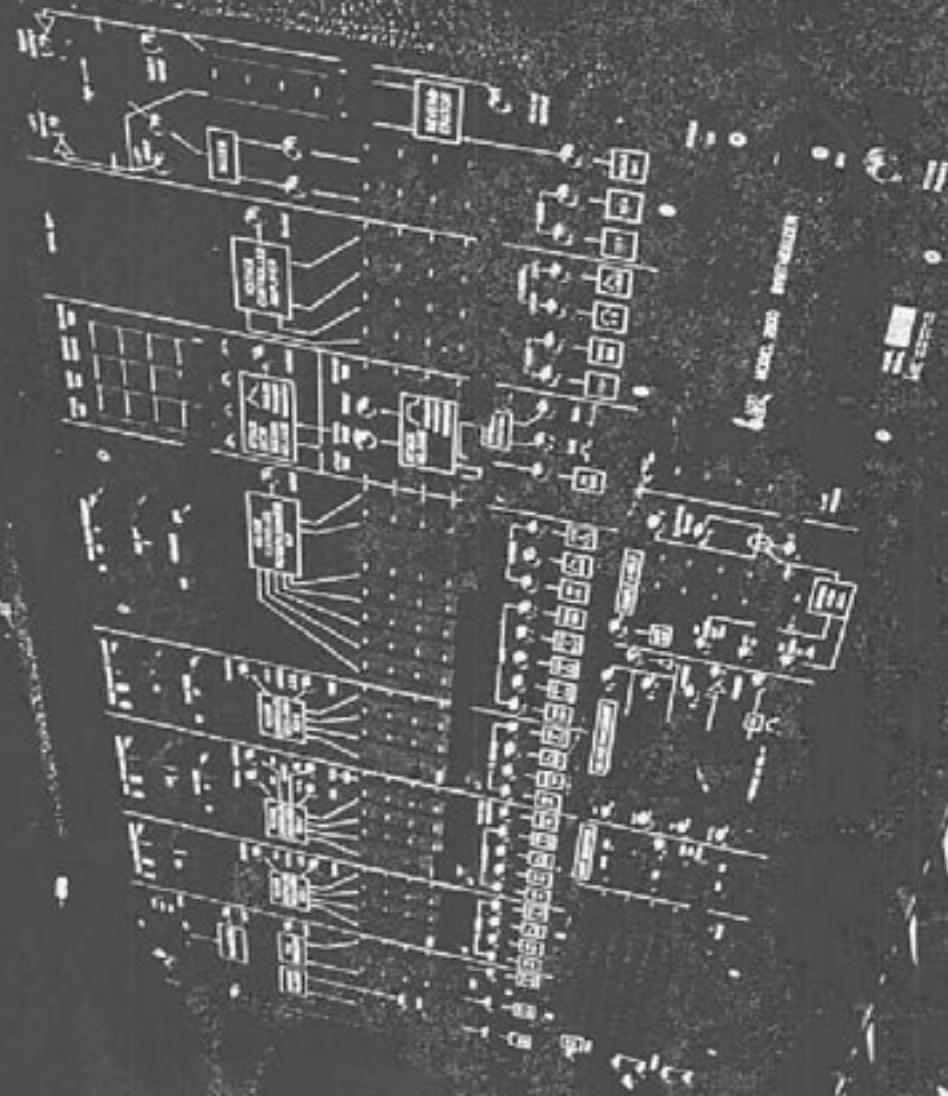

www.oldschool-sound.co.uk

!!!!!! An exclusive free release !!!!!!

SCAN by PASCAL.W -aka- "Analog Monkey"

Free manuals for Free Vintage addicts ! Creative use only

\$\$\$ Not For Resale \$\$\$

(: Le bizness de ressources est un sport de ptizizis :)

2600 Patch Book



# The ARP 2600 Patch Book

## TABLE OF CONTENTS

### Basic Instruments

1. Marimba Roll
2. Trumpet & French Horn
3. Truckee Bass
4. Octobass
5. Wonder Clavinet
6. String Sweetener
7. Tubular Chimes
8. Violin
9. English Horn/Oboe
10. Fanfare Trumpet
11. Monster Organ
12. Thereminovox
13. Cello Section
14. Cowboy Harmonica
15. Classic ARP 2600 Patch
16. Electric Mouth-harp
17. Licorice Schtück
18. Big Bass Drum
19. Trombone/Tuba
20. Flute
21. Okie Guitar
22. Jazz Guitar

### Advanced Instruments

23. Ceramperial Gong
24. Heavy Metal Fuzz Lead
25. 65¢ Piano
26. Doc Trumpet
27. Stereo Bass & Delayed Violin
28. Oriental String Duo
29. Pianoforte
30. Big Band Brass
31. Electronic Piano
32. Zombie Organ
33. Glitter Guitar
34. Marimba: Chords and Lead
35. Handbells
36. Pennywhistle & Trumpet
37. Violin with Delayed Vibrato

### Rhythms

38. Swing Traps: Hi-hat & Bass Drum
39. Metallic Thanks
40. Triple Timings
41. Tom & Hi-hat Duet
42. Steel Drum Corps
43. Advanced Steel Drum Corps
44. Random ARP Drum Solo
45. Back-beat: Bass Drum, Hi-hat & Tom
46. Cockin' Conga
47. Conga & Snare Drum Duet

### Natural Sounds

48. Frog Bog
49. Jonathan Synthesized Seagull
50. Primeval Forest
51. Arboretum
52. Soprano
53. Sporadic Heavy Breathing
54. Cricket Colony
55. Clapping Thunder
56. Small Barking Muti
57. Random Whistler
58. Mother Whistler
59. ARP Jungle
60. Water Drops
61. Stereo Chickadee Conversation
62. "Oh Yeah!"

### Arpeggios, Chords & Sequences

63. Inverted ADSR Harmonic Arpeggio
64. Three-note Tunable Sequence
65. Three-note Chord from Two VCOs
66. Inharmonic Sequencing
67. Random Select: Four-note Tunable Arpeggio
68. Gliding Intervals

### Sound Effects

69. Firetruck Siren with Horn Blast
70. 727 Starting Up, Taxing, & Taking Off
71. Panning Freight Train
72. Edgar Winter's "Frankenstein"
73. Boing!
74. Wampus Monster
75. Assorted Splats & Springs
76. Prancing Raindrops
77. "Pwer" or Synthesized High-pass Filter
78. Explosion

### Advanced Applications

79. Ultraglide with Release Memory
80. Trio: Three Separate Envelopes & Timbres
81. Lagged S/H to Filter
82. "Owwa" or Inverted ADSR to VCF
83. Basic Vibrato from Internal Oscillator
84. Lagged Keyboard Voltage
85. ADSR Pan
86. Auto-pan on S/H
87. Auto-pan with Reverb
88. Keyboard-controlled Pan
89. Release-follow
90. Touch-repeat
91. S/H Echo
92. Echoplex
93. Random Filter Sample: Keyboard Triggered
94. Voltage-controlled Resonance
95. Voltage-controlled On-time
96. Etheral Phase-shifting on External Source
97. Modulated External Source
98. "Ow" on External Source
99. Drum-controlled ADSR & S/H
100. Split Keyboard: Bass "Ow" & Violin

# Welcome

Welcome to the ARP 2600 Patch Book. These instrumental timbres, sound effects, natural sounds and rhythms are the result of over three years of experimentation by many people, both amateur and professional, who are deeply involved with electronic music synthesis. A large number of these patches have already been used in commercial recording; you might already have heard them on the radio, TV, movie soundtracks and record albums. We'd like to share them with you.

You'll progress more rapidly and derive more satisfaction from this book if you take these thoughts into account:

- A patch chart is only a *guide*, not a precise configuration of sliders. Be flexible - the patch charts are.
- Every individual synthesizer has its own slight idiosyncracies. Slider positions on your 2600 might vary slightly from the norm set by the patch charts, so if you don't get exactly the sound you want, make minor corrections in control settings. Follow your ear.
- And every set of eardrums also has its idiosyncracies. If you like your flutes mellow, your monsters creepier, or your drums kickier, experiment a little.
- To get full enjoyment from synthesizing these sounds, blow them through a good speaker system. The speakers on the front of the 2600 are there for reference; you should be playing through an amp and speaker system with a full-range response.
- We don't have to tell you that it's fun to experiment with your own ideas; that's expected of electronic musicians. Many of these patches can be set up simultaneously: try the String Sweetener with the Auto-pan, for example. You will undoubtedly come up with some great patches of your own and will want to write them down. Blank 2600 Patch Pads are available from the factory at \$1.00 each.

ARP would like to thank these people for getting it together in this 2600 Patch Book: Dave Fredericks, Roger Dumas, David Friend, Bruce McLendon, Phil Dodds, Alan R. Pearlman, Tom Piggott, Mike Brigida, Rick Parent, Bernie Klocko, Dan Hakala, John Shykun, Bill Wentz, Edgar Winter, Margaret Shepherd, and a couple of anonymous folks who sent in some dynamite patches.

# Heed These Hints:

1. Be certain that all sliders and switches not indicated on the patches are in the *left or down* positions.

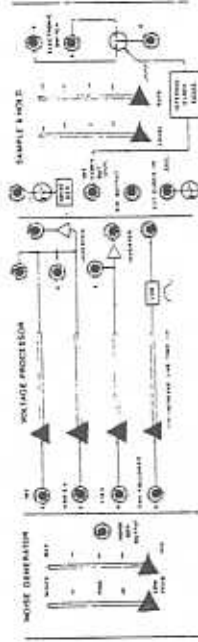

2. Arrows indicate the positions to which sliders should be moved *after tuning or during performance*.

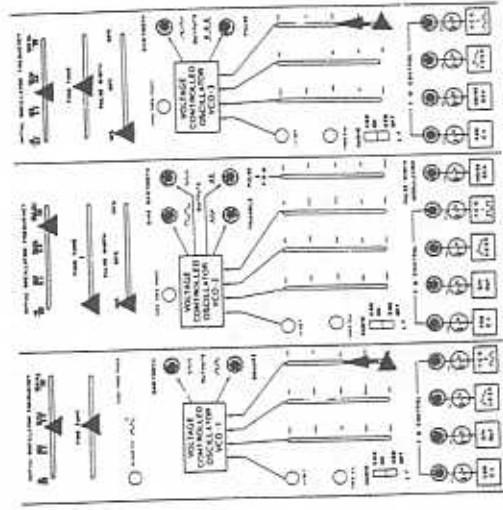

3. Shut the speakers off while you're setting the patch up. It's easy to get distracted by unrivra sounds.



4. Pay special attention to the information located in the corners on most of the patches. There you will discover how many patchcords and dummy plugs are needed, how the portamento and tuning knobs are to be used, and where to play on the keyboard.

5. Set aside the number of patchcords you'll need for the patch before you plug anything in. Otherwise, the patch may be missing a patch-cord and you won't notice it right away.

6. *Phrasing* is most important on the instrumental patches. If you can play the keyboard with the idea that you are pausing to take breaths on a flute or trumpet, or bowing back and forth on a violin, you'll have more success synthesizing those instruments.

7. **VCO Pitch Tuning:** The keyboard diagrams over each patch indicate the pitch tunings for the VCOs and occasionally the VCF. For instance, this diagram means "Play Key C3 & tune VCO 3 to middle C." (Of course, if you don't have a tuning source such as a piano or a pitchpipe, you can tune the oscillators approximately.)

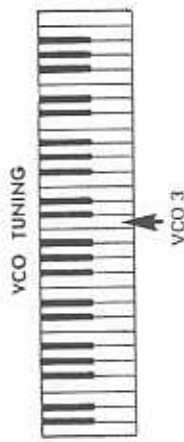

8. Several patches will ask you to precisely tune two or three oscillators to unison or octave intervals. Tune one oscillator to the frequency range indicated on the patch chart and compare the other oscillators to it individually. When two oscillators are close to a harmonic interval, (in this case, a unison, octave, fifth or a fourth), you will hear "beats." Beats sound like a combination of tremolo and phasershifting: the frequencies of the two oscillators are so close that they tend to cancel each other out periodically. This can more easily be heard if you run the oscillators through the Ring Mod.

Play a note and fine-tune the oscillator you are comparing to the basic pitch until the beats slow down to less than one every three seconds. This is easiest at unison, harder at an octave, and requires practice for perfect fourths and fifths. The best way to check for a precise tuning is to play higher notes than the one used for tuning. The beats will be faster at higher frequencies.

*Interval Tuning Example: Patch No. 35, Marimba Chords & Lead*

1. Raise VCO 3  $\leftarrow$  into VCF. Play Key C1 and tune VCO 3 to a low, recognizable pitch.
2. Play Key G3, still listening to VCO 3. This is the pitch to which you will tune VCO 2.
3. Close VCO 3  $\rightarrow$  at the VCF and raise VCO 2  $\leftarrow$ . Play C1 and tune VCO 2 to the pitch you heard at step 2.
4. To check for proper tuning, go back and forth: Play G3  $\rightarrow$  listen to VCO 3. Play C1  $\rightarrow$  listen to VCO 2.
5. Try this procedure in tuning VCO 1 at three octaves and a minor third above VCO 3 (Key Eflat4).
6. Raise all three VCOs into VCF and play the bottom octave.

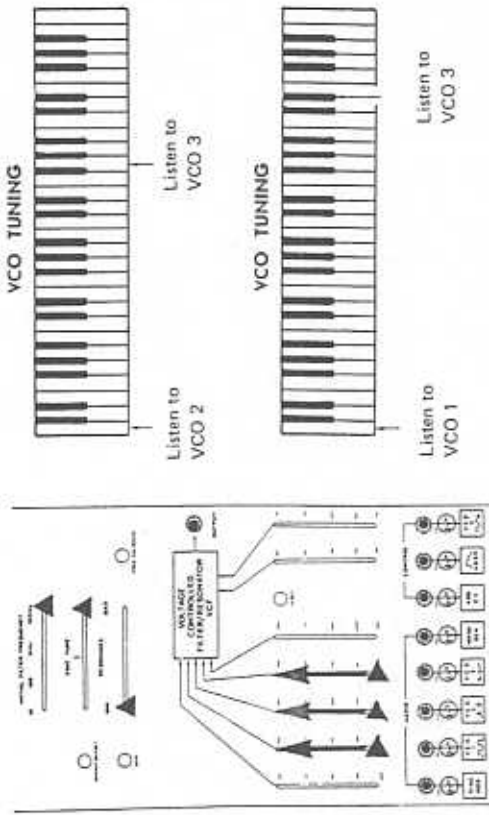

Don't be discouraged if the sound you want doesn't automatically appear like a candy bar out of a vending machine. Chancers are good that you've forgotten to switch on the S/H Gate, the Oscillator Frequency Switches, or the power. Another possibility might be that one of the patchcords isn't plugged in fully. With practice, you'll be able to troubleshoot any problem encountered with any patch. They all work when set up properly.

# Basic Instruments



KEYBOARD RANGE: BOTTOM 2 OCTAVES

VCO TUNING



VCO 2

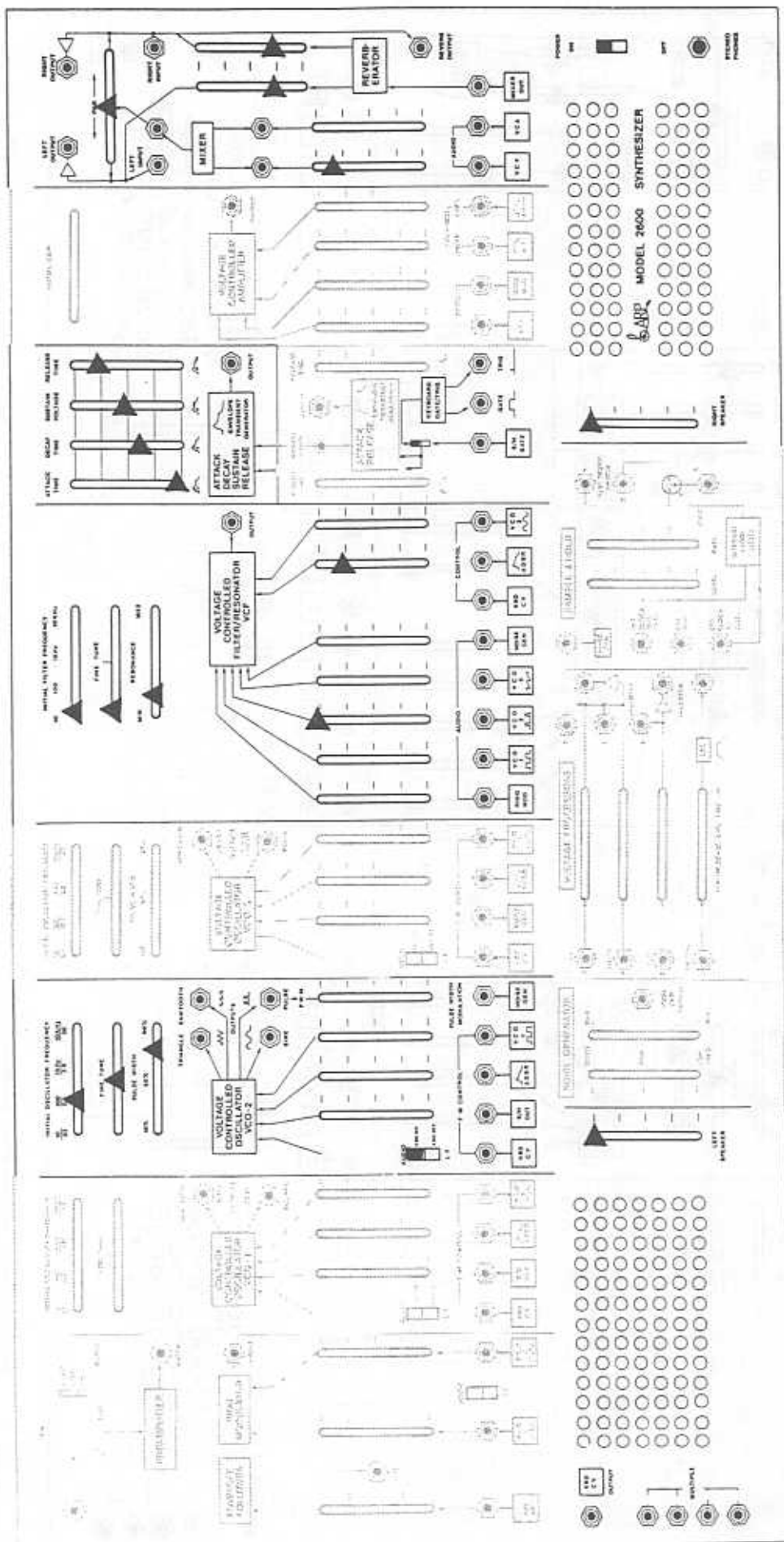

Trucker Bass

3.

VCO TUNING



VCO 2

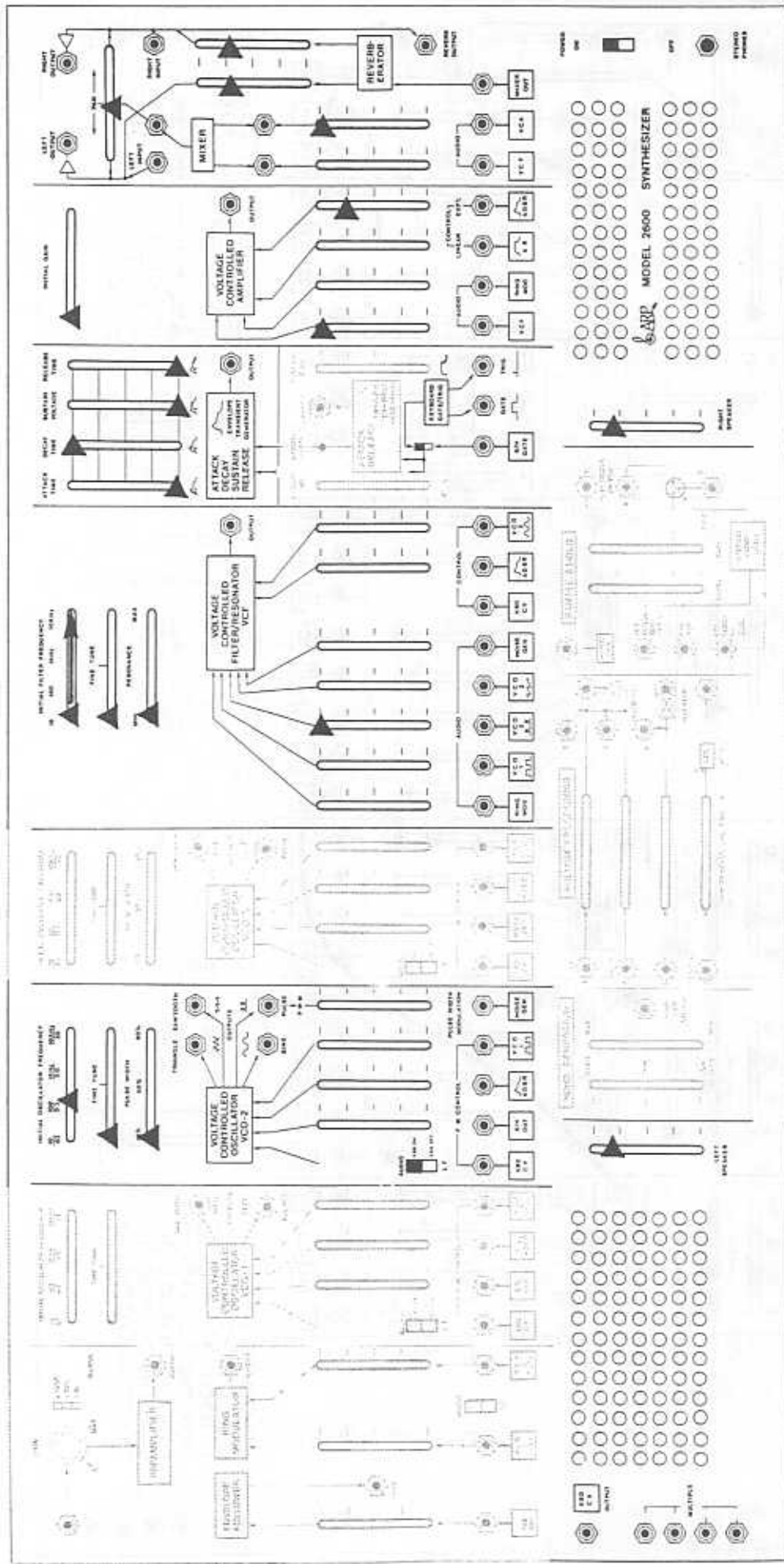

1. Adjust VCF ← for brightness.
2. Tune VCO 2 to middle C.

# Wonder Clavinet



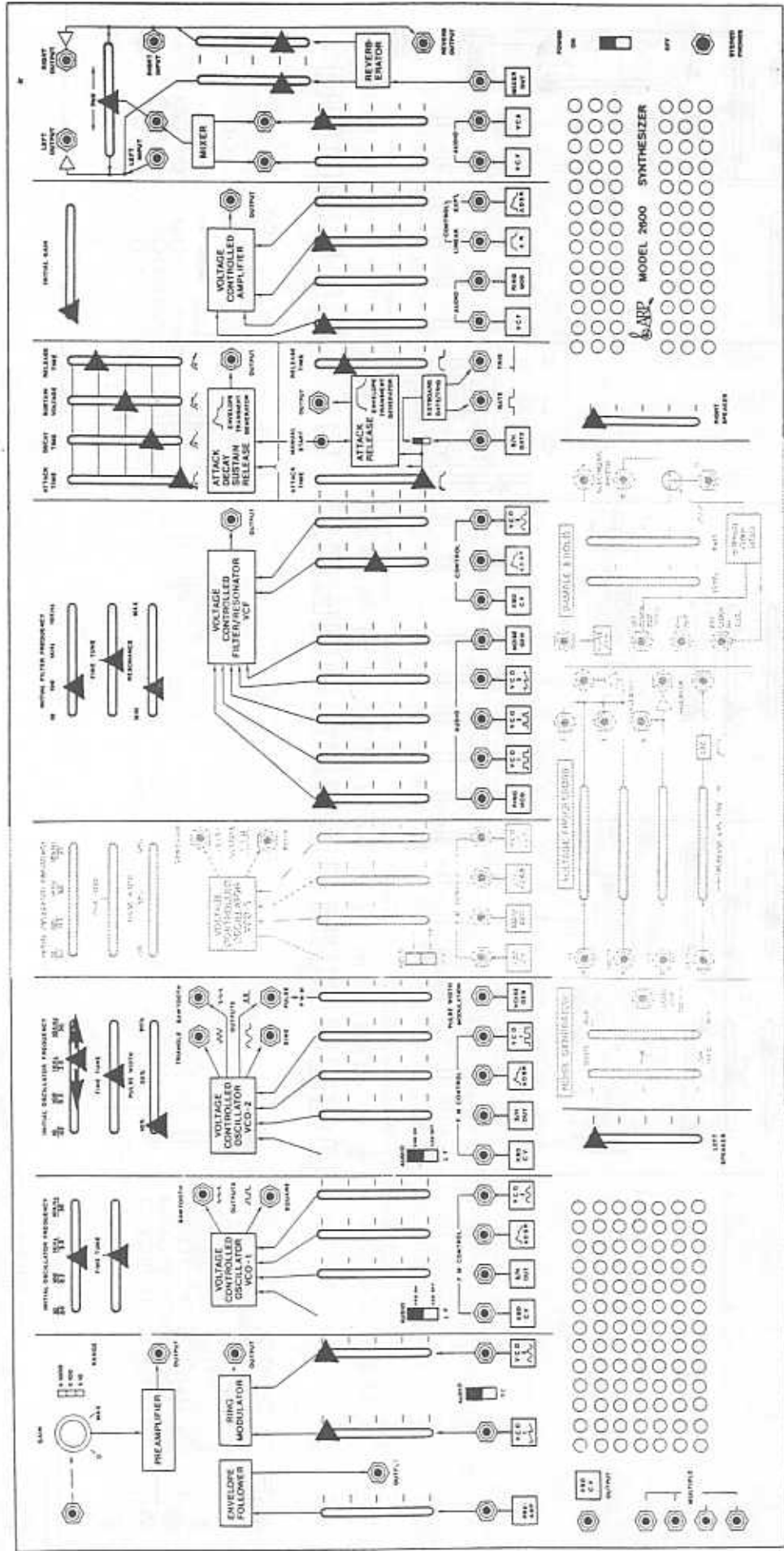

Adjust VCO 2 frequency for different bell effects.

# Tubular Chimes

VCO TUNING



VCO 3

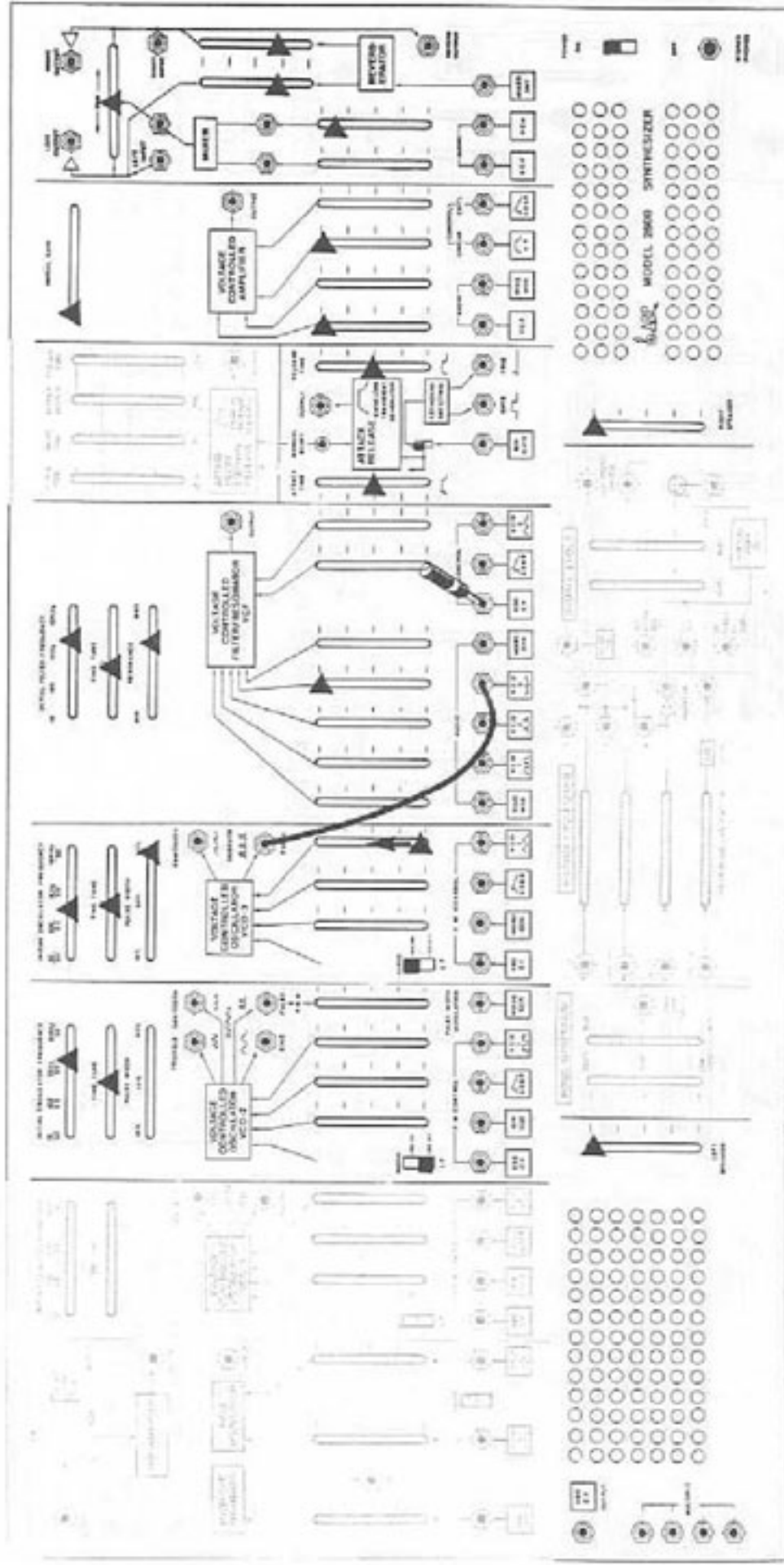

1. Tune VCO 3 to middle C.
2. Raise VCO 2  $\frac{1}{2}$  into VCO 3 for vibrato.
3. Adjust VCO 2 frequency for vibrato speed.

**PRODSCHOOL-SOUND.COM**  
 www.prodschool-sound.com  
 \*\*\*\*\* An exclusive free release !!!!!

SCAN by PASCAL.W -aka- "Analog Monkey"  
 Free manuals for Free Vintage addicts ! Creative use only  
 \$\$\$ Not For Resale \$\$\$  
 (: Le bizness de ressources est un sport de pitizis :)

1 PATCHCORD  
 1 DUMMY PLUG

English Horn/Oboe

9.

VCO TUNING

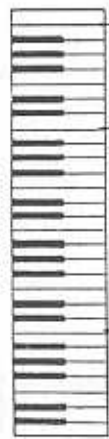

VCO 1 VCO 2

VCO 3

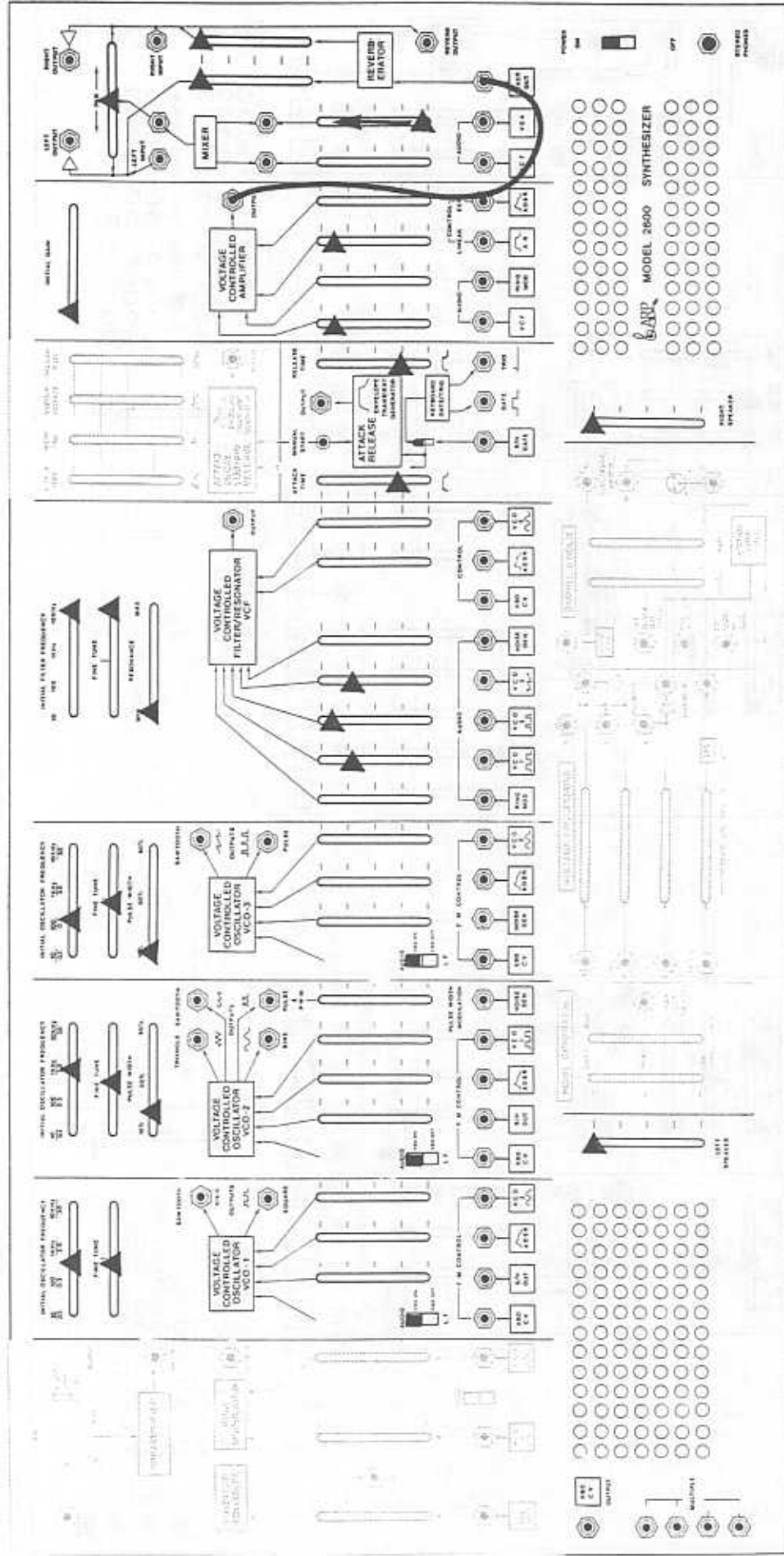

1. Tune: VCO 1 to one octave above middle C.  
VCO 2 to two octaves above middle C.  
VCO 3 to one octave below middle C.  
Raise VCA 1 into Mixer for brilliance.

1 PATCHCORD

Monster Organ

11.

VCO TUNING



VCO 1+3

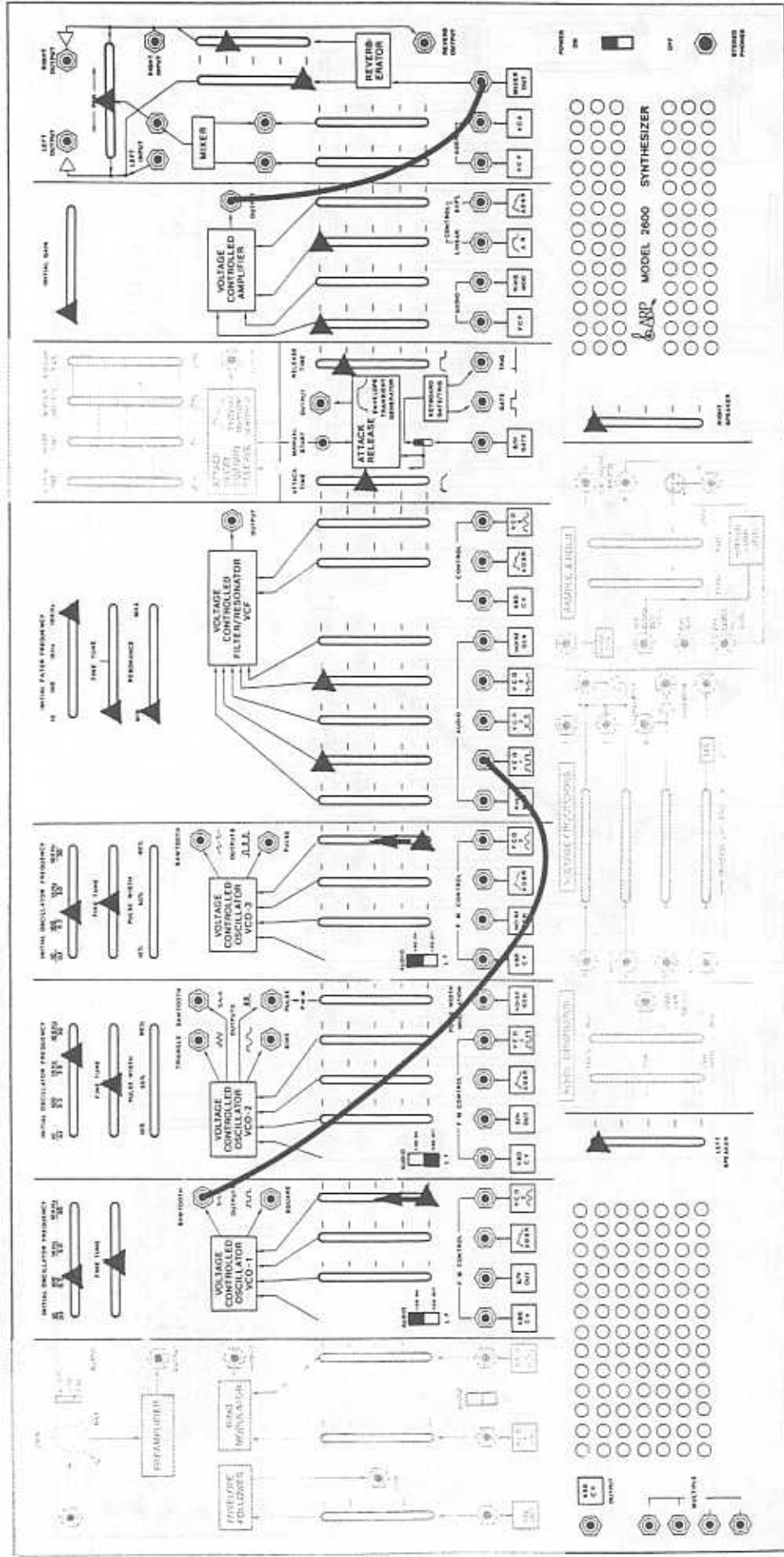

Parlamento

2 PATCHCORDE

1. Tune VCO 1 and 3 to one octave below middle C
2. Listening to each oscillator individually, raise VCO 2 1 into each for vibrato and adjust VCO 2 frequency for speed.

# Cello Section



### VCO TUNING



VCO 1  
VCO 2  
VCO 3

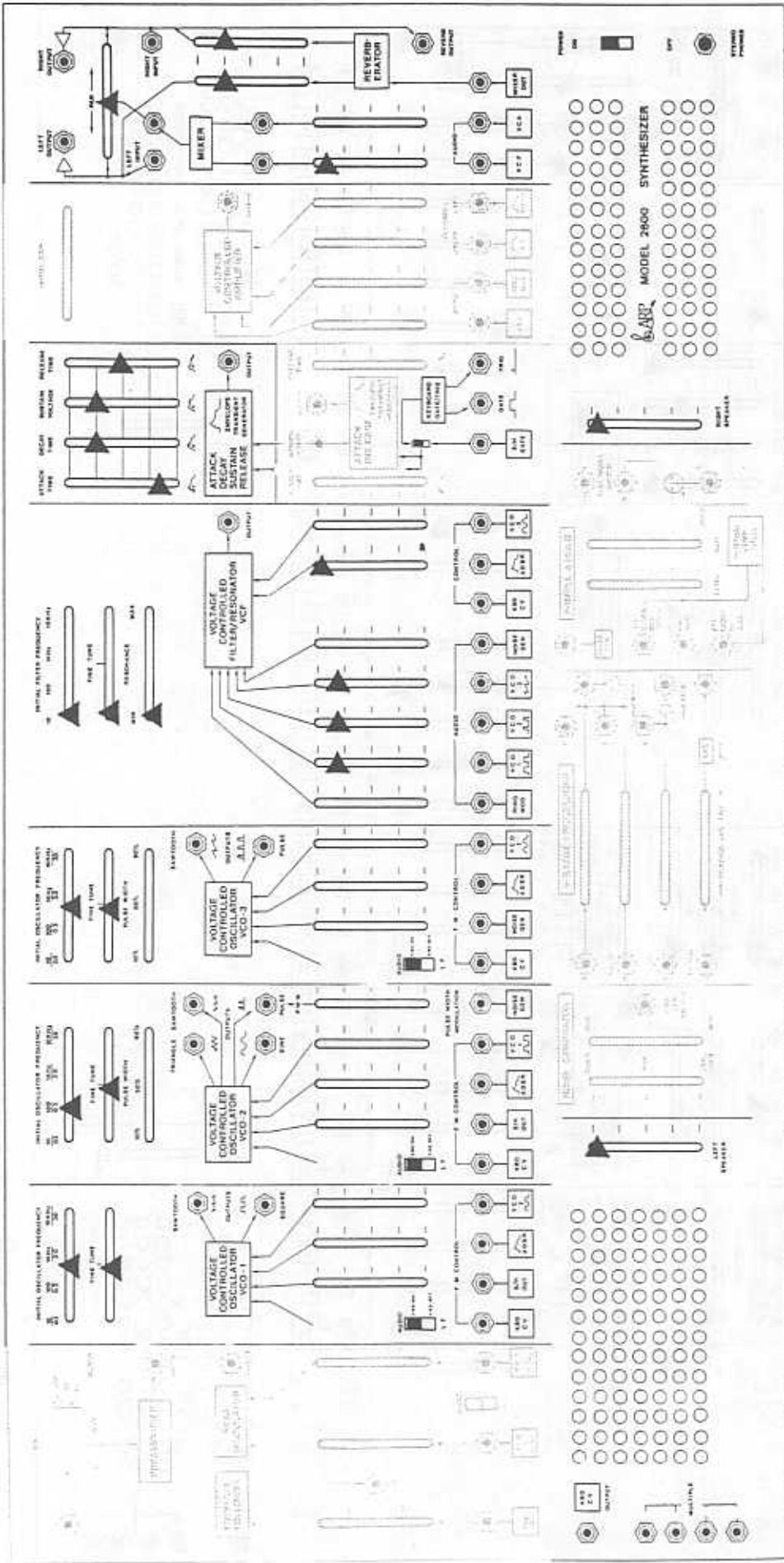

Portamento



Tune: VCO 1 to middle C.  
VCO 2 to one octave below middle C.  
VCO 3 to middle C.

# Classic ARP 2600 Patch

VCO TUNING



VCO 1

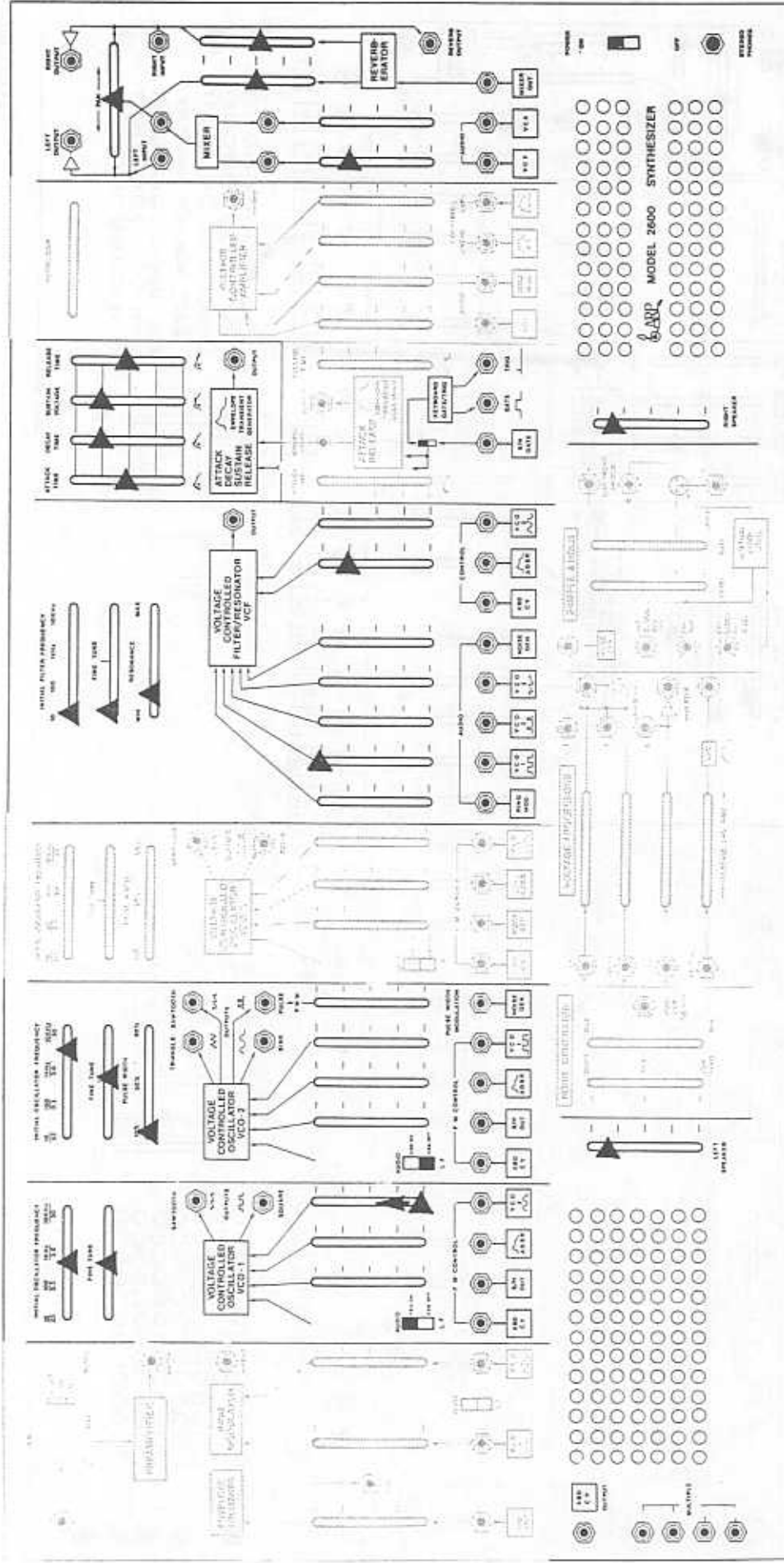

1. Tune VCO 1 to middle C.
2. Raise VCO 2 | into VCO 1 for vibrato.
3. Adjust VCO 2 frequency for vibrato speed.



## VCO TUNING



VCO 3

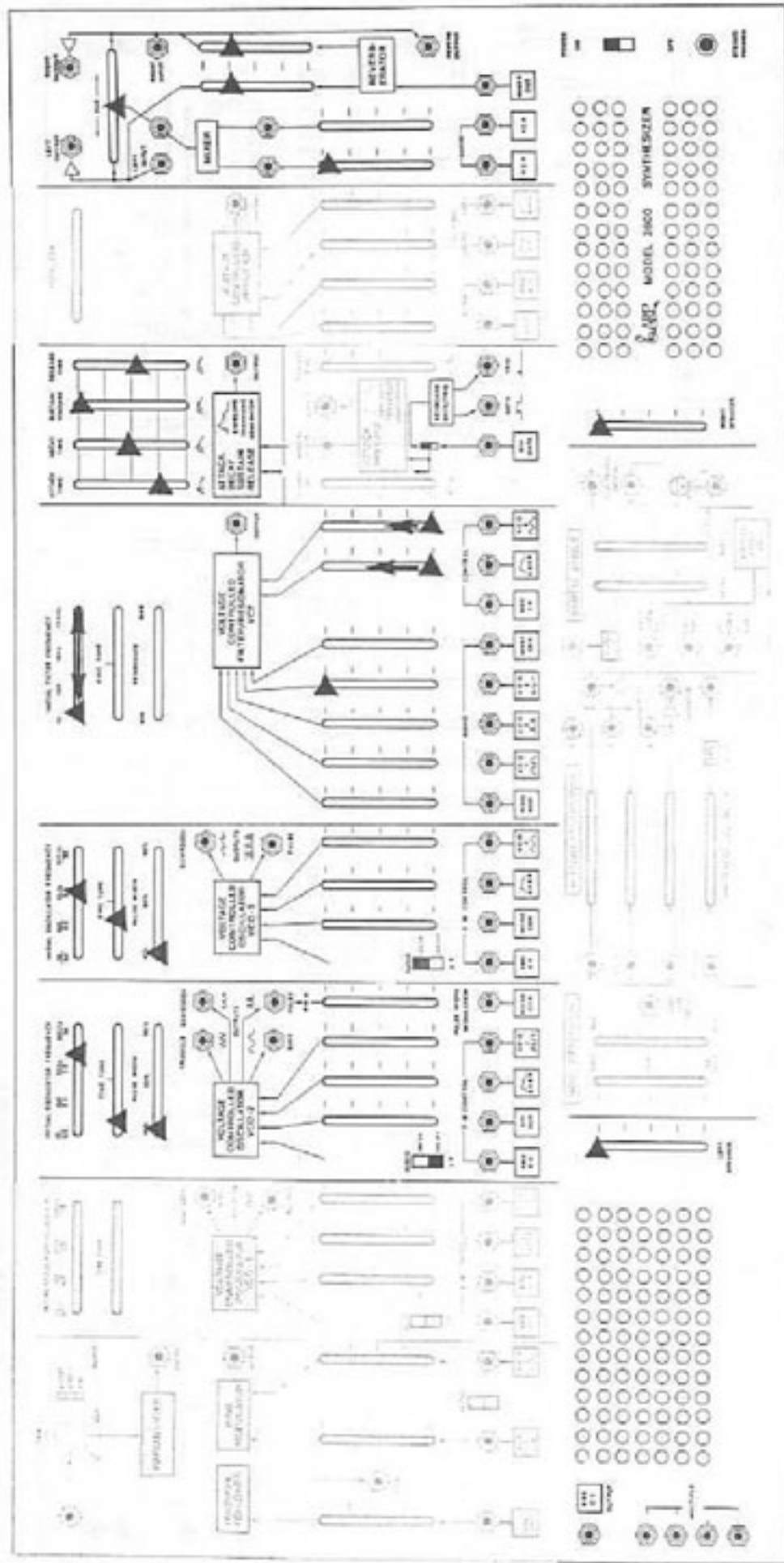

**PROSCHOOL-SOUND**  
[www.oldschool-sound.com](http://www.oldschool-sound.com)  
 !!!!! An exclusive free release !!!!!

Free manuals for Free Vintage addicts ! Creative use only  
 \$\$\$ Not For Resale \$\$\$  
 (: Le bizness de ressources est un sport de pitizis :)

1. Open VCF → and tune VCO 3 to one octave above middle C.
2. Close VCF → and raise ADSR ↑ into VCF for brightness.
3. Raise VCO 2 ↑ into VCF for tremolo.
4. Adjust VCO 2 frequency for tremolo speed.

Flute

20.



# VCO TUNING



VCO 3

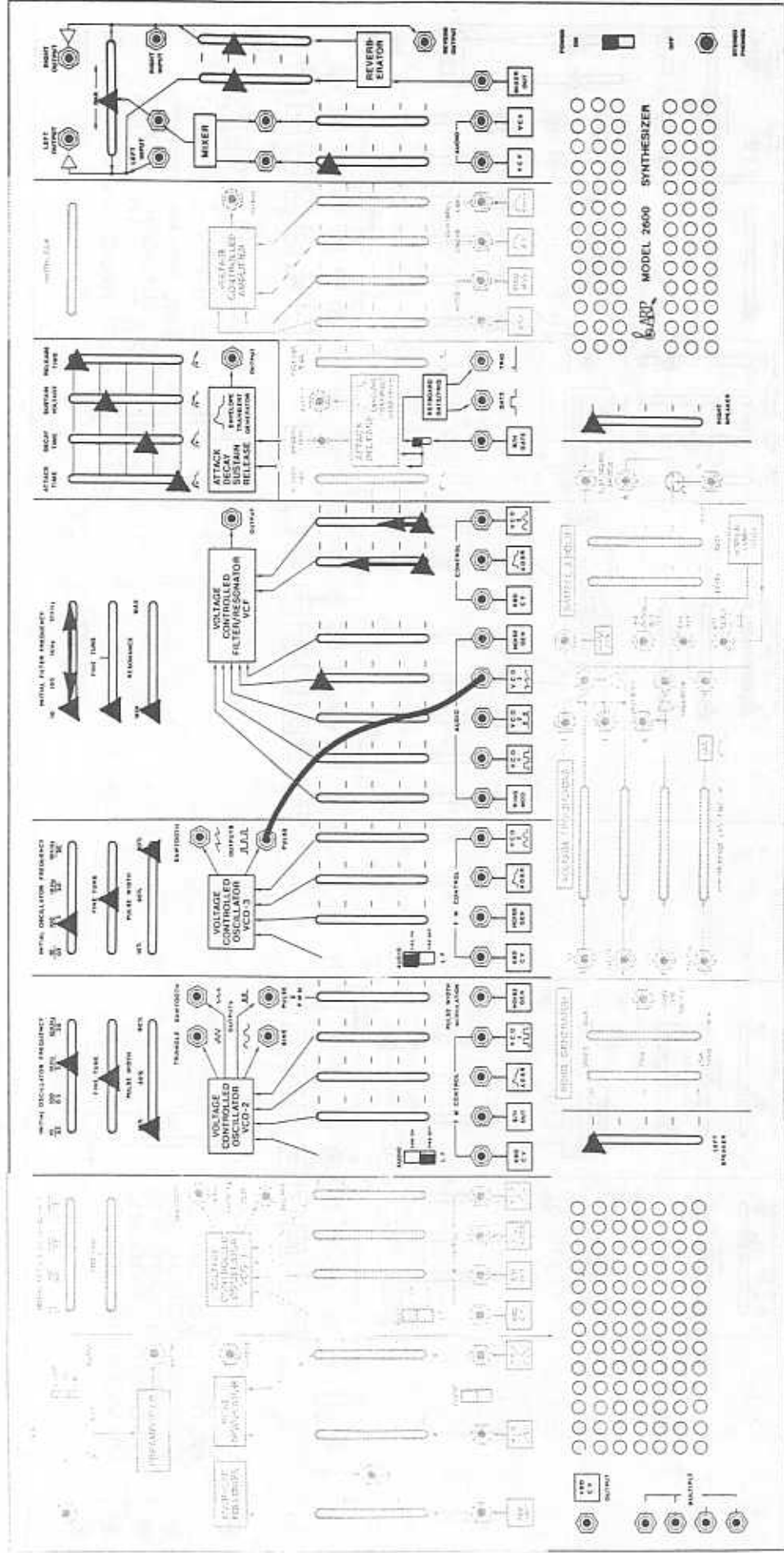

1 PATCHCORD

1. Open VCF — and tune VCO 3 to one octave below middle C.
2. Close VCF — and raise ADSR and VCO 2 | into VCF.
3. Adjust VCO2 frequency for tremolo speed.

# Advanced Instruments



### VCO TUNING



VCO 1+3

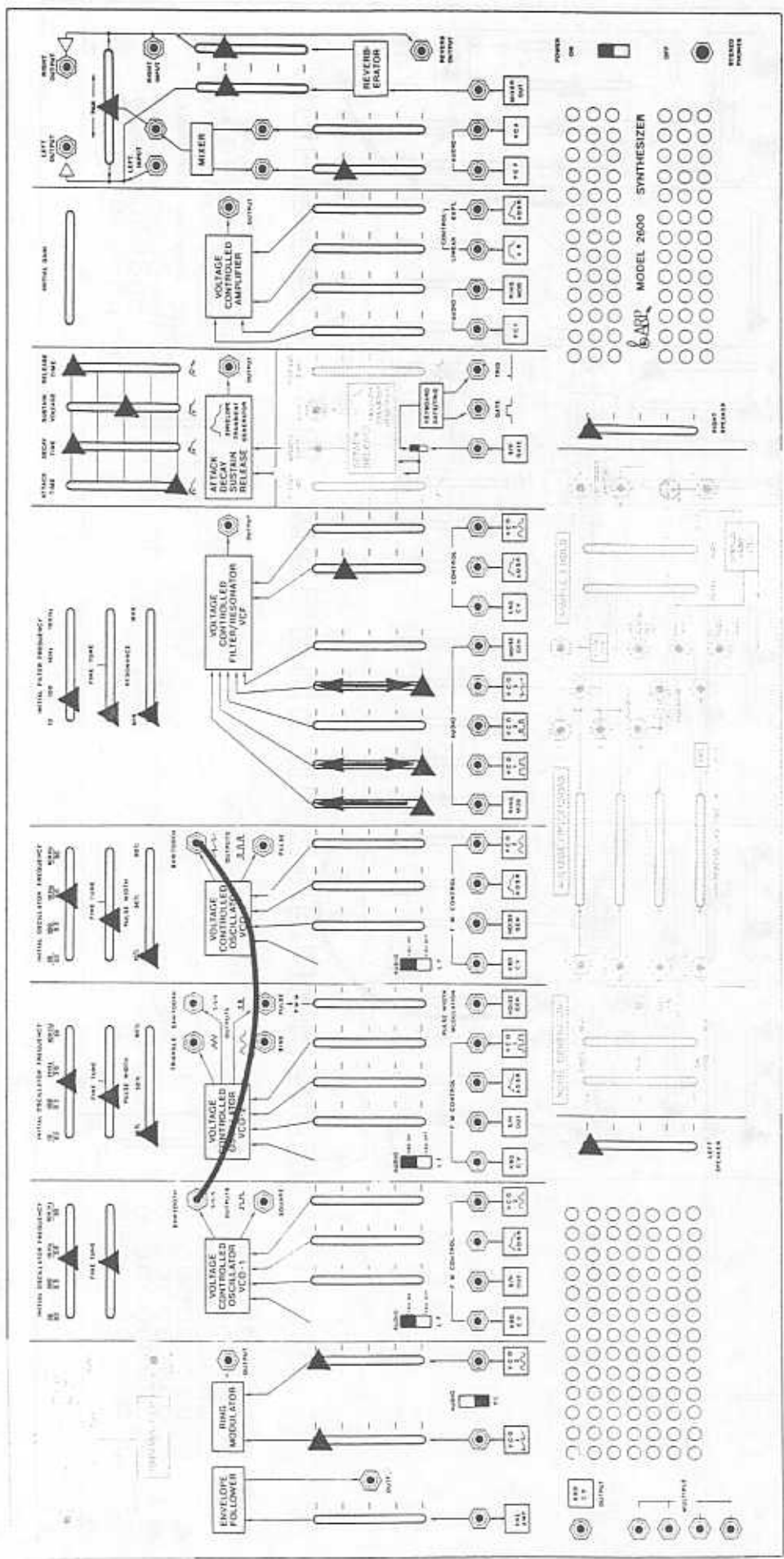

1. Raise VCO 1 and 3 | into VCF.
2. Tune VCO 1 and 3 to middle C.
3. Detune VCO 3 by a few beats.
4. Close VCO 1 and 3 | and raise Ring Mod | into VCF.
5. Adjust VCO 2 frequency for different effects.

1 PATCHCORD

# Ceremonial Gong

# 23.

KEYBOARD RANGE: TOP 2 OCTAVES

VCO TUNING



VCO 2+3  
VCO 1

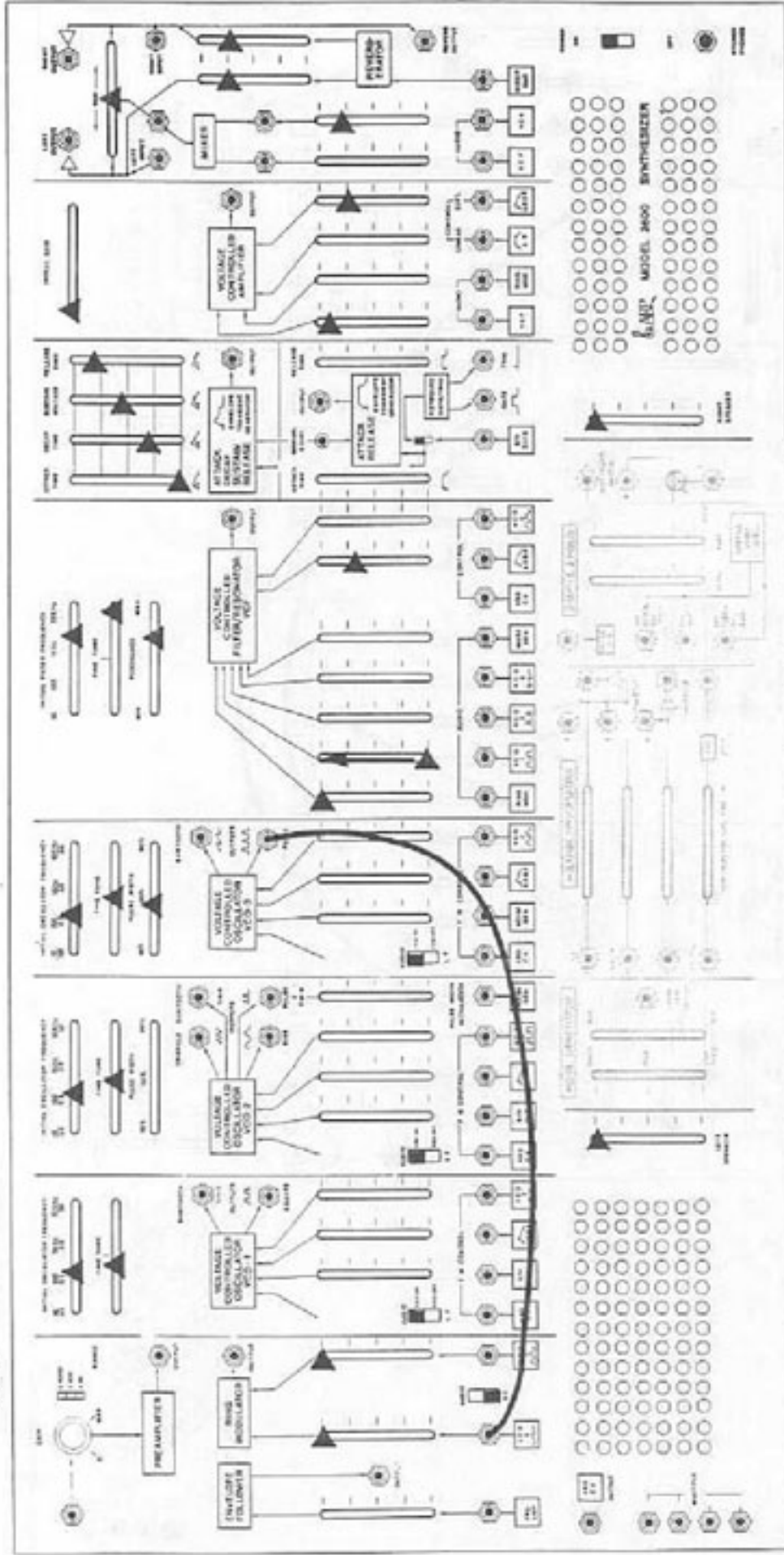

1. Tune VCO 2 and 3 to middle C.
2. Place VCO 1 into VCF and tune a low beat off.

**PROSCHOOL-SOUND**  
www.proschool-sound.com

!!!!!! An exclusive free release !!!!!!

SCAN by PASCAL W - aka- "Analog Monkey"

Free manuals for Free Vintage addicts ! Creative use only

\$\$\$ Not For Resale \$\$\$

(: Le bizness de ressources est un sport de ptizisis :)

1 PATCHCORD

655f Piano

25.

VCO TUNING



VCO 2 VCO 3 VCO 1

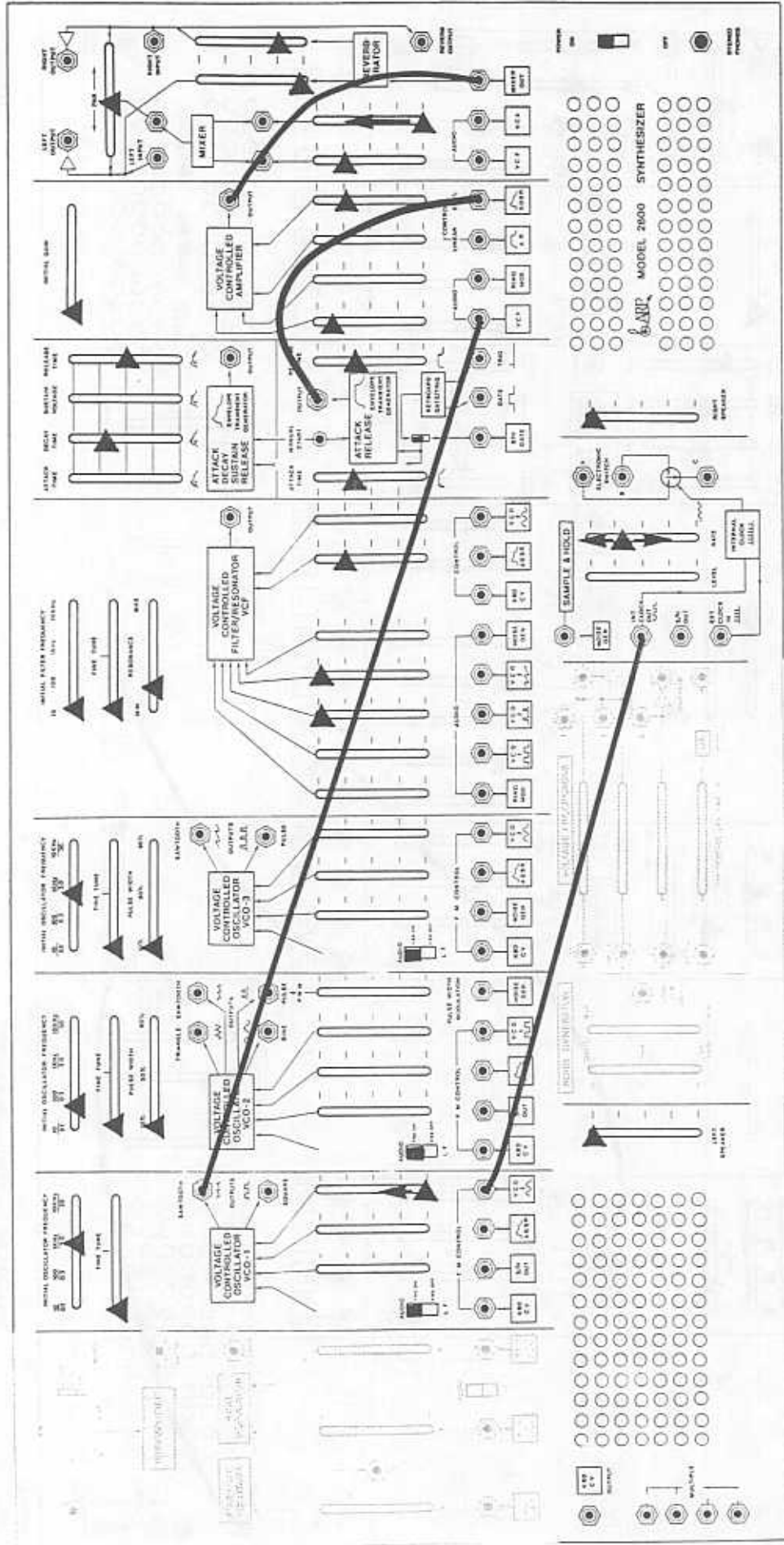

1. Tune: VCO 3 to middle C.  
VCO 2 to one octave below middle C.  
VCO 1 to one octave above middle C.
2. Raise | into VCO 1 and adjust S/H Rate for vibrato speed.
3. Raise VCA | into Mixer for violin presence.

4 PATCHCORDS

# Stereo Bass & Delayed Violin

# 27.

VCO TUNING

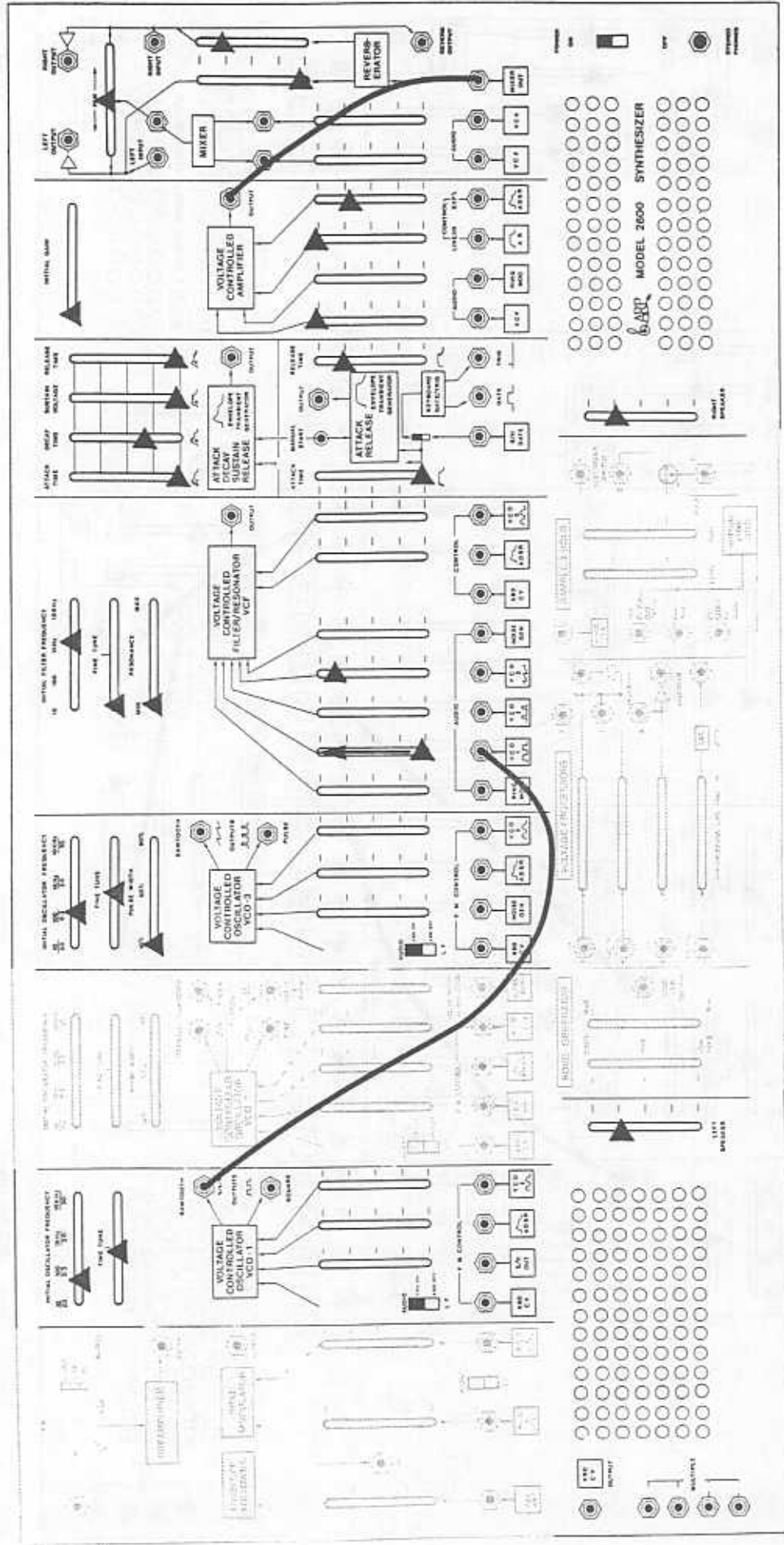

1. Tune: VCO 3 to middle C.  
VCO 1 to an octave below middle C.
2. Raise VCO 1 into VCF for depth.
3. Adjust VCF frequency for brightness.

2 PATCHCORDS



VCO TUNING



VCO 2+3

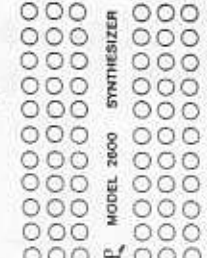
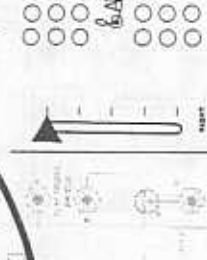
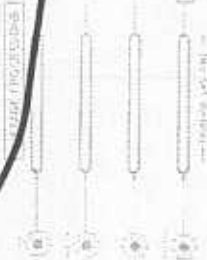
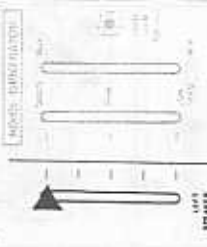
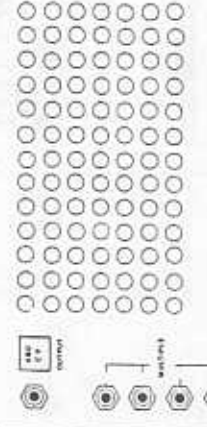
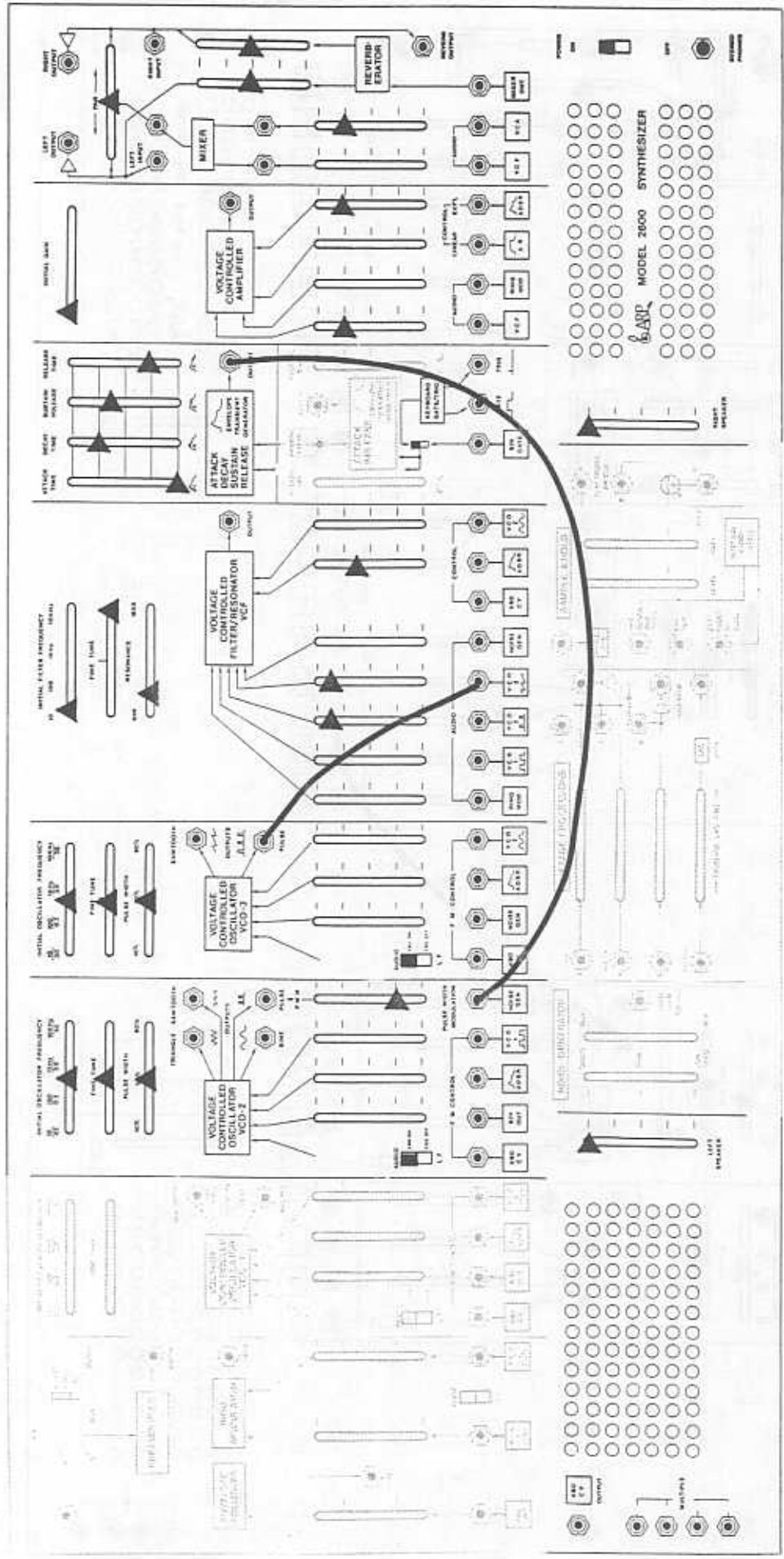

MOOG MODEL 2600 SYNTHESIZER

Tune VCO 2 and 3 to middle C.  
Pulse Widths must be 50%.

2 PATCHCORDS

# Electronic Piano

VCO TUNING



VCO 2  
VCO 3

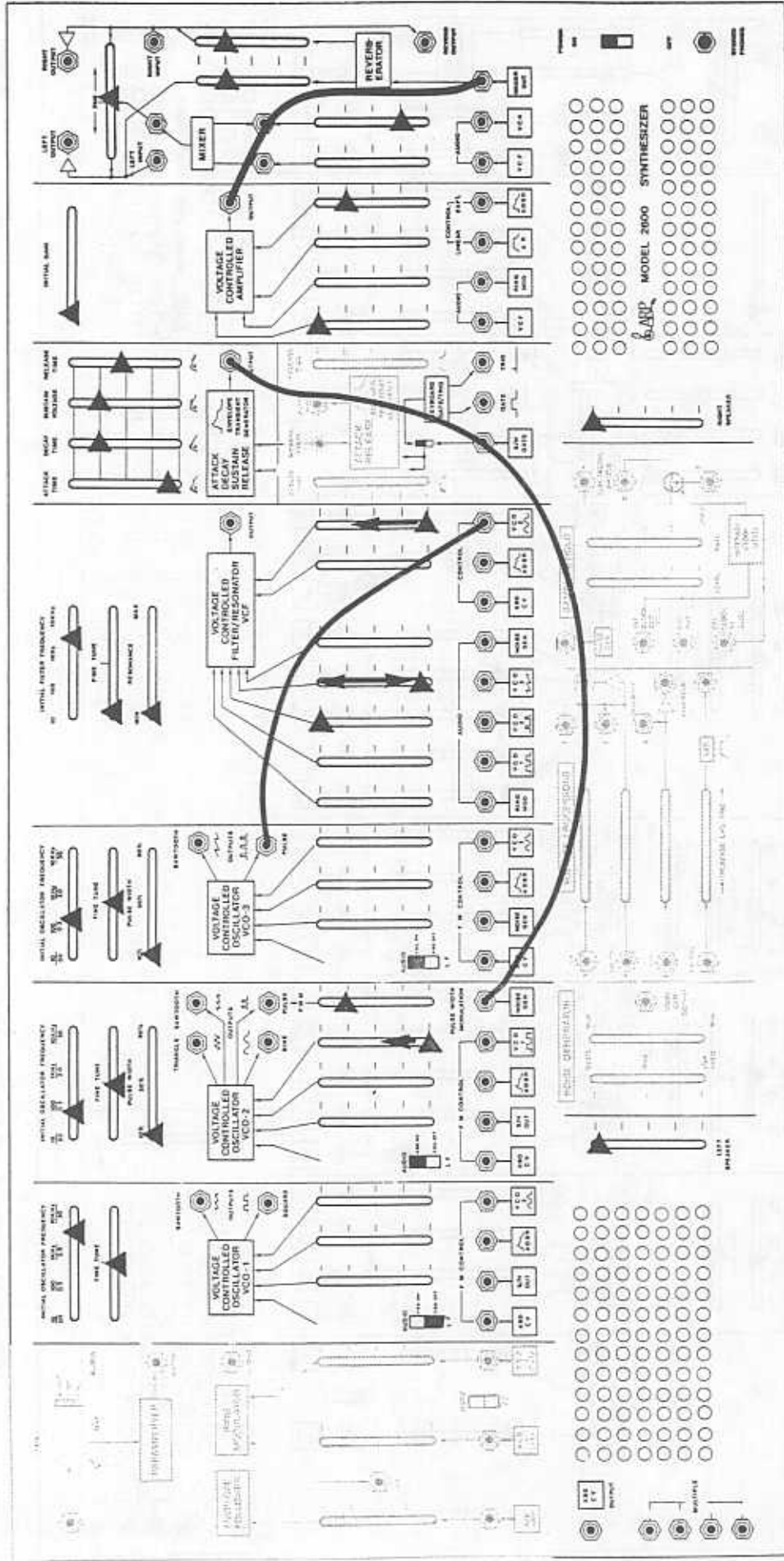

Tuning

1. Tune VCO 2 as shown.
2. Raise VCO 3  $\frac{1}{2}$  into VCF and tune VCO 3 to an octave and a major third above VCO 2. (See intro.)
3. Close VCO 3 | at VCF and raise | into VCF Control to level shown.
4. Raise VCO 1  $\frac{1}{2}$  into VCO 2 and adjust VCO 1 frequency for vibrato speed.
5. Bring VCO 1  $\frac{1}{2}$  in and out of VCO 2 for vibrato during performance.

3 PATCHCORDS

# Glitter Guitar

# 33.



KEYBOARD RANGE: BOTTOM 2 OCTAVES

VCO TUNING

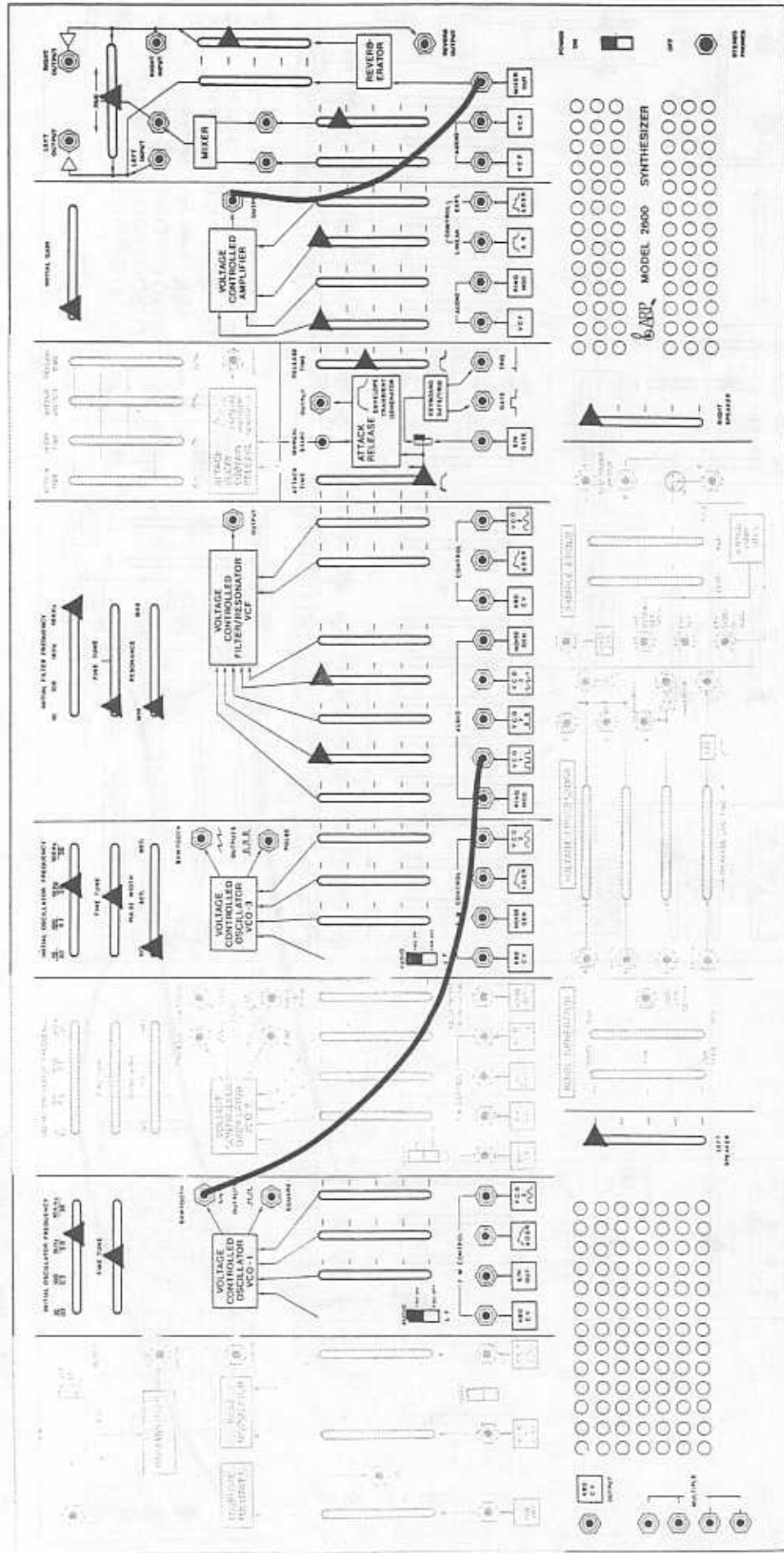

1. Tune: VCO 3 as shown.  
VCO 1 to one octave and a fourth above VCO 3.
2. Play in short rapid bursts.

2 PATCHCORDS

VCO TUNING

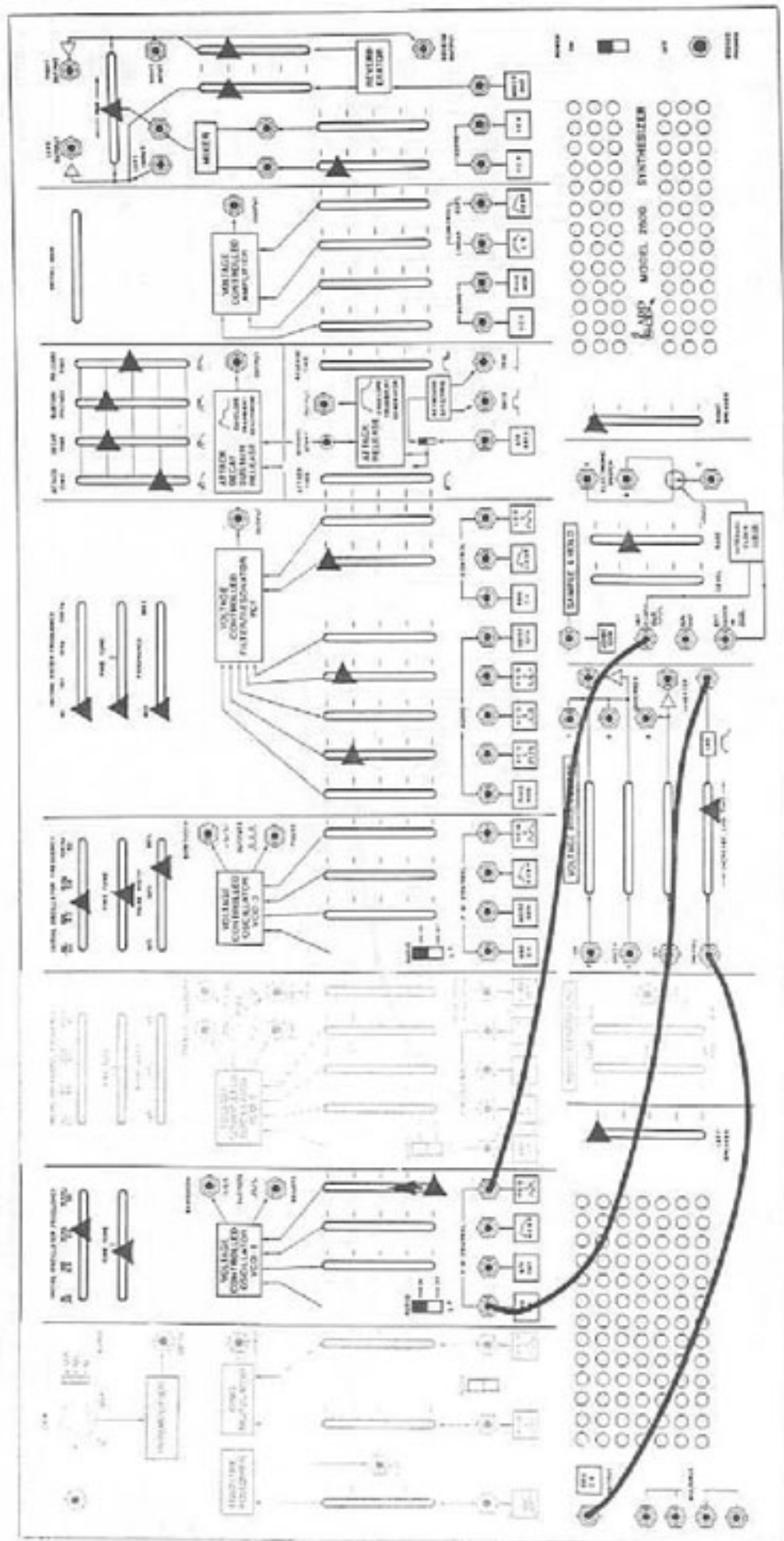
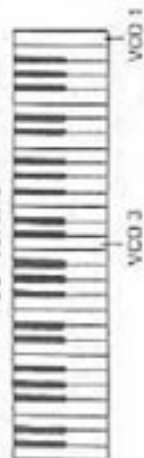

3 PATCHBOARDS

**oldschool-sound.com**  
 www.oldschool-sound.com  
 !!!!!! An exclusive free release !!!!!!

SCAN by PASCAL W -aka- "Analog Monkey"  
 Free manuals for Free Vintage addicts ! Creative use only  
 \$\$\$ Not For Resale \$\$\$  
 (: Le bizness de ressources est un sport de pitizais :)

1. Tune VCO 3 to middle C.  
 VCO 1 to two octaves above middle C.  
 VCO 2 into VCO 1 and adjust SH Rate for vibrato speed.
2. Raise
3. Note: Whistle will have vibrato and glide; Trumpet is straight.

# Pennywhistle & Trumpet

36.

VCO TUNING



VCO 3

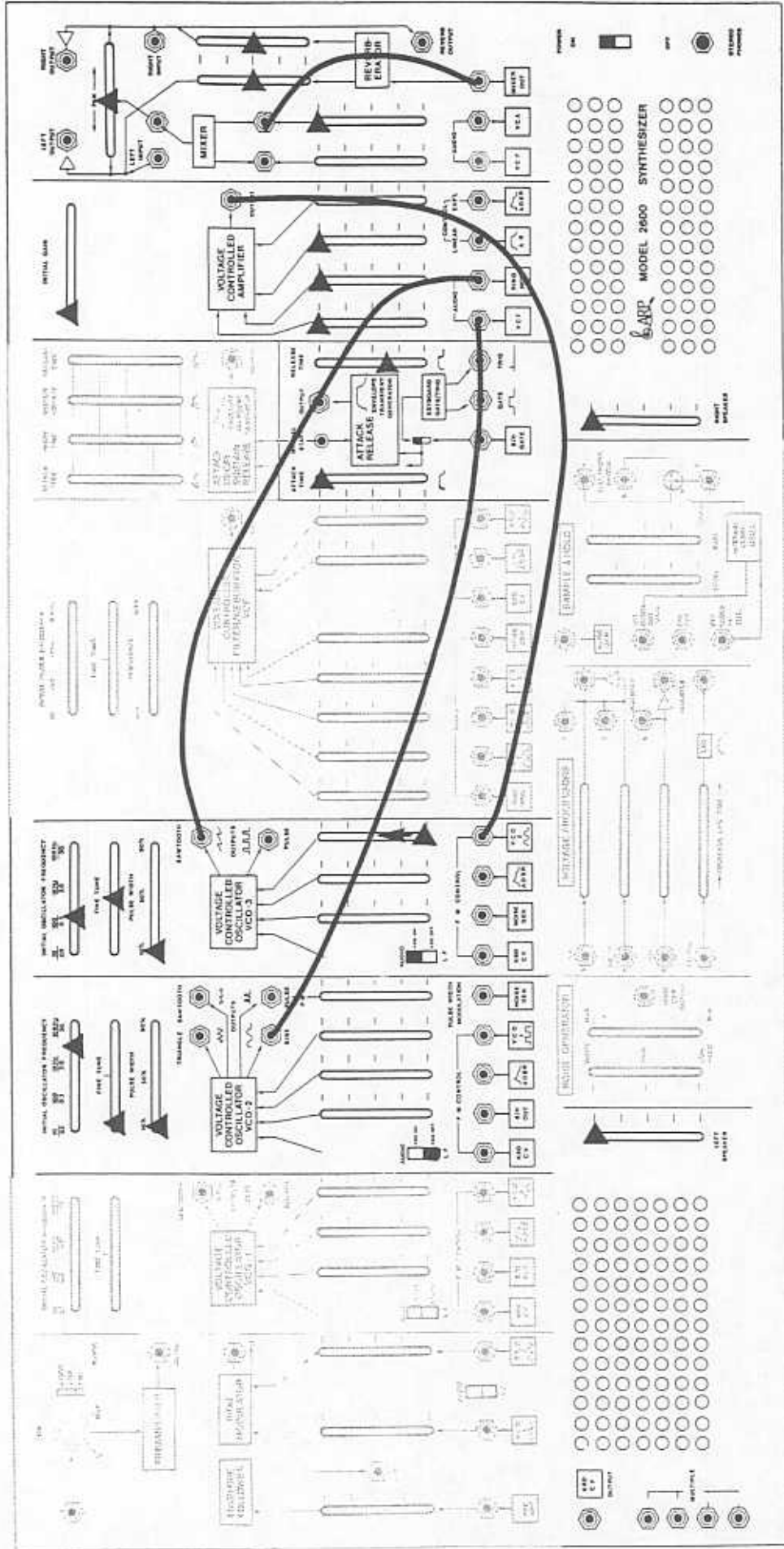

4 PATCHCORDS

1. Tune VCO 3 to an octave above middle C.
2. Raise VCO 2  $\sim$  into VCO 3 and adjust VCO 2 frequency for vibrato speed.

Note: Play legato for vibrato; play staccato for no vibrato.

# Violin with Delayed Vibrato

# Rhythms

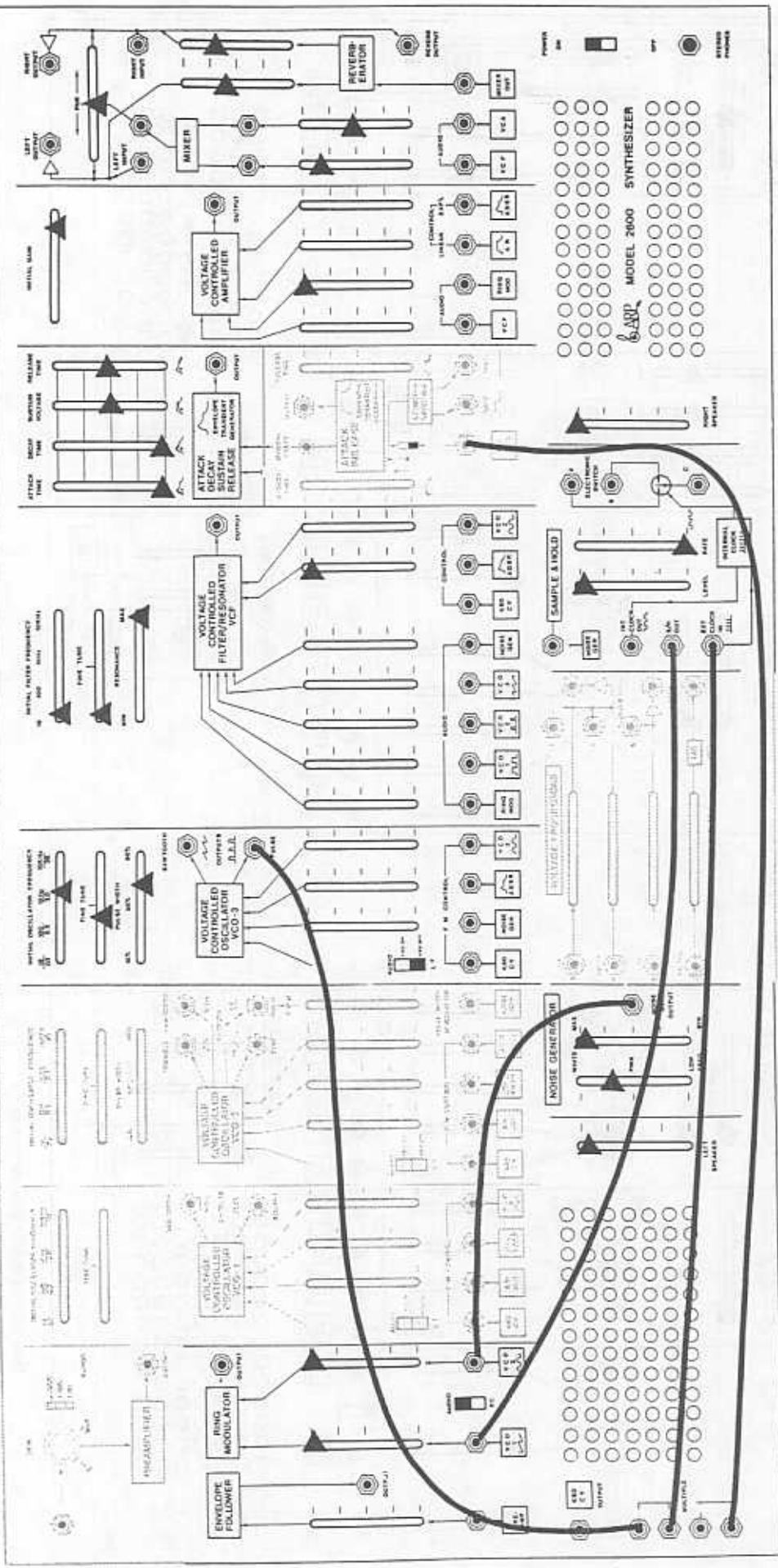

5 PATCHCORDS

Adjust: VCO 3 frequency for tempo.  
ADSR into VCF for BASS Drum timbre.

# Swing Traps: Hi-Hat & Bass Drum 38.

VCO 1  
VCO 2  
VCO 3

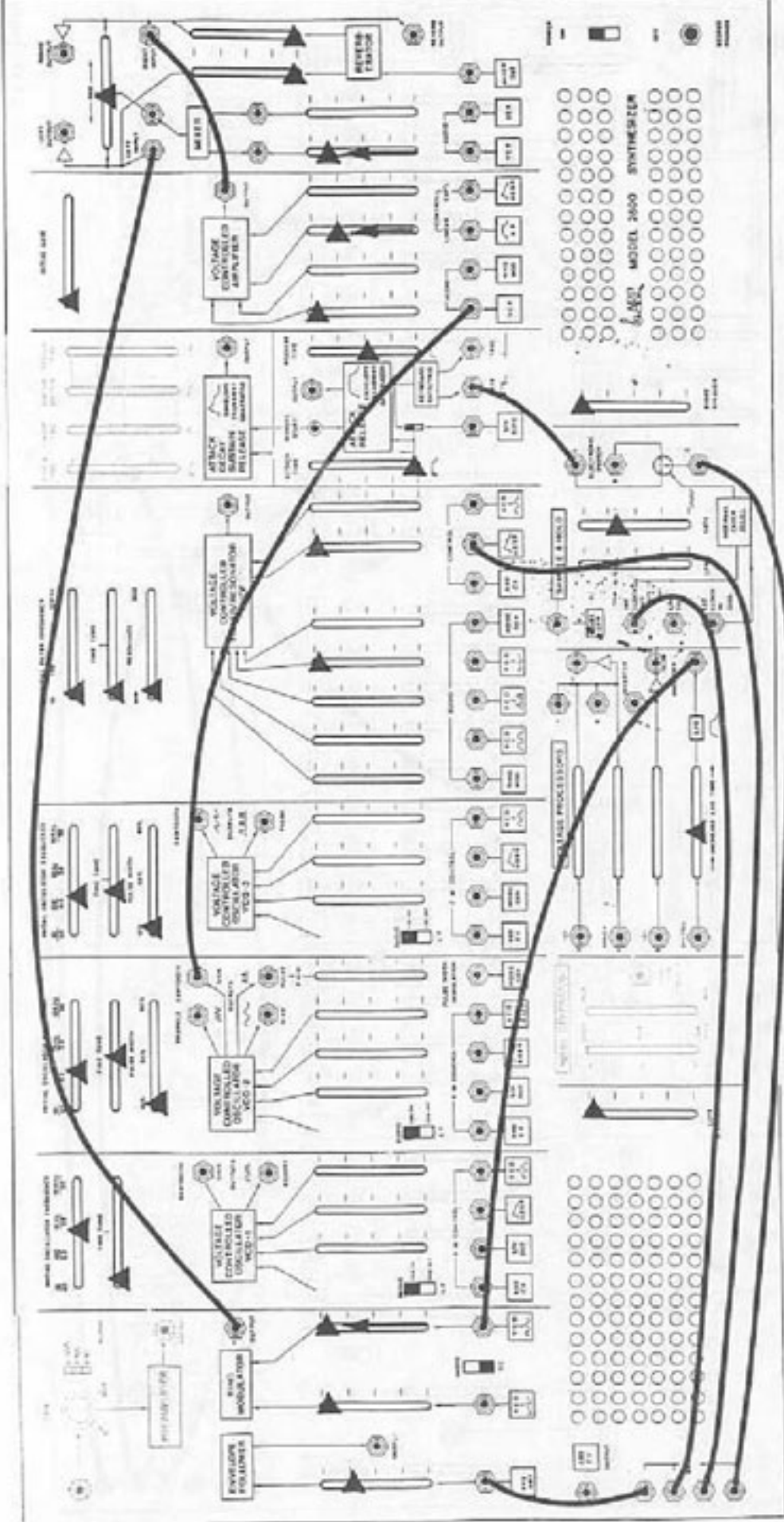

9 PATCHCARDS

**www.oldschool-sound.com**  
!!!!!! An exclusive free release !!!!!!

SCAN by PASCAL W - aka - "Analog Monkey"  
Free manuals for Free Vintage addicts ! Creative use only  
\$\$\$ Not For Resale \$\$\$  
( Le bizness de ressources est un sport de ptizizis ! )

Turn VCO 1, 2, and 3 as desired.  
3 separate volume controls | at Ring Mod, AF at VCA, VCF at Mixer.

Triple Timings

40.





ARP Random ARP Drum Solo

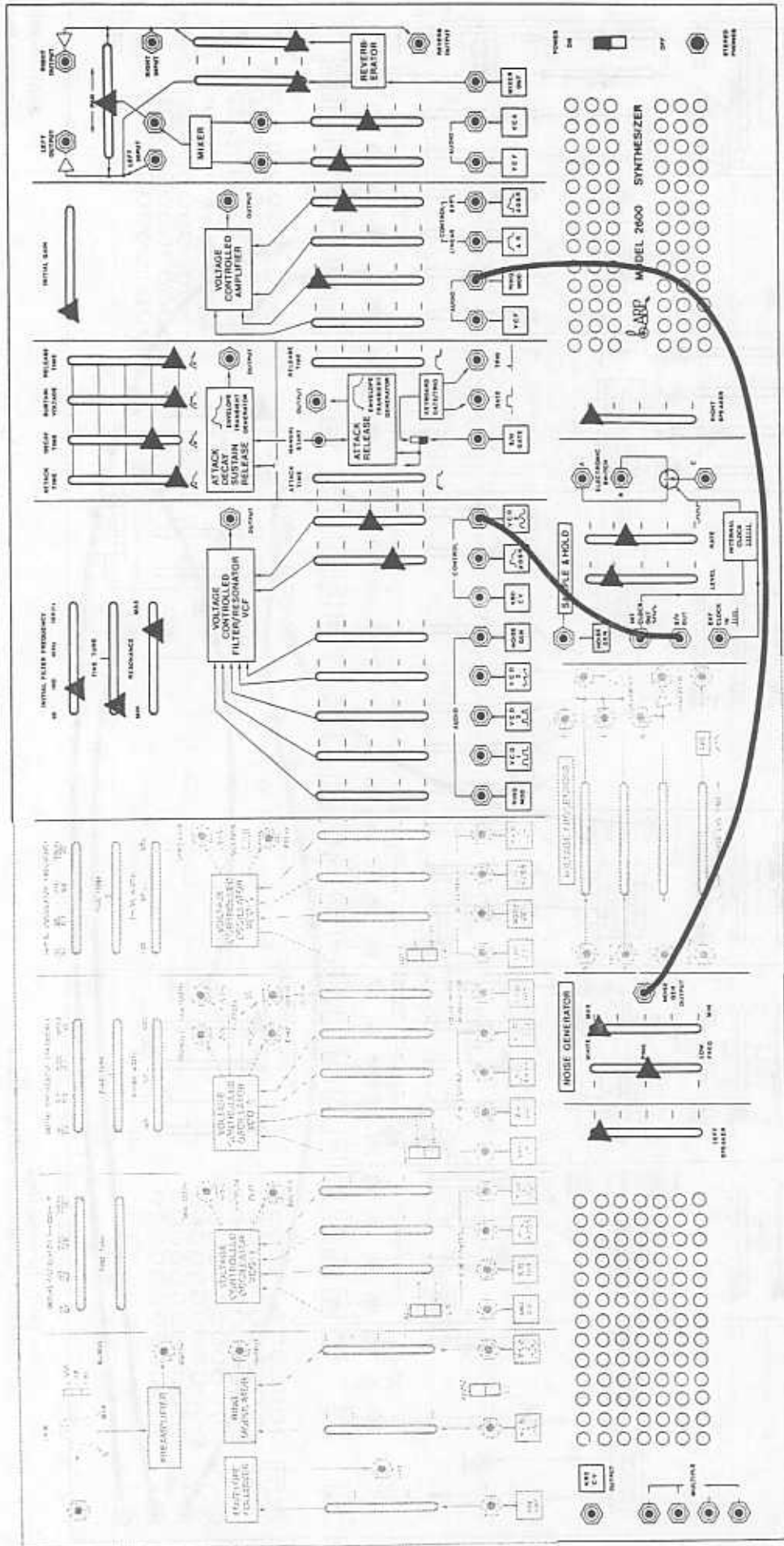

Adjust S/H Rate for tempo.

2 PATCHCORDS

# Random ARP Drum Solo



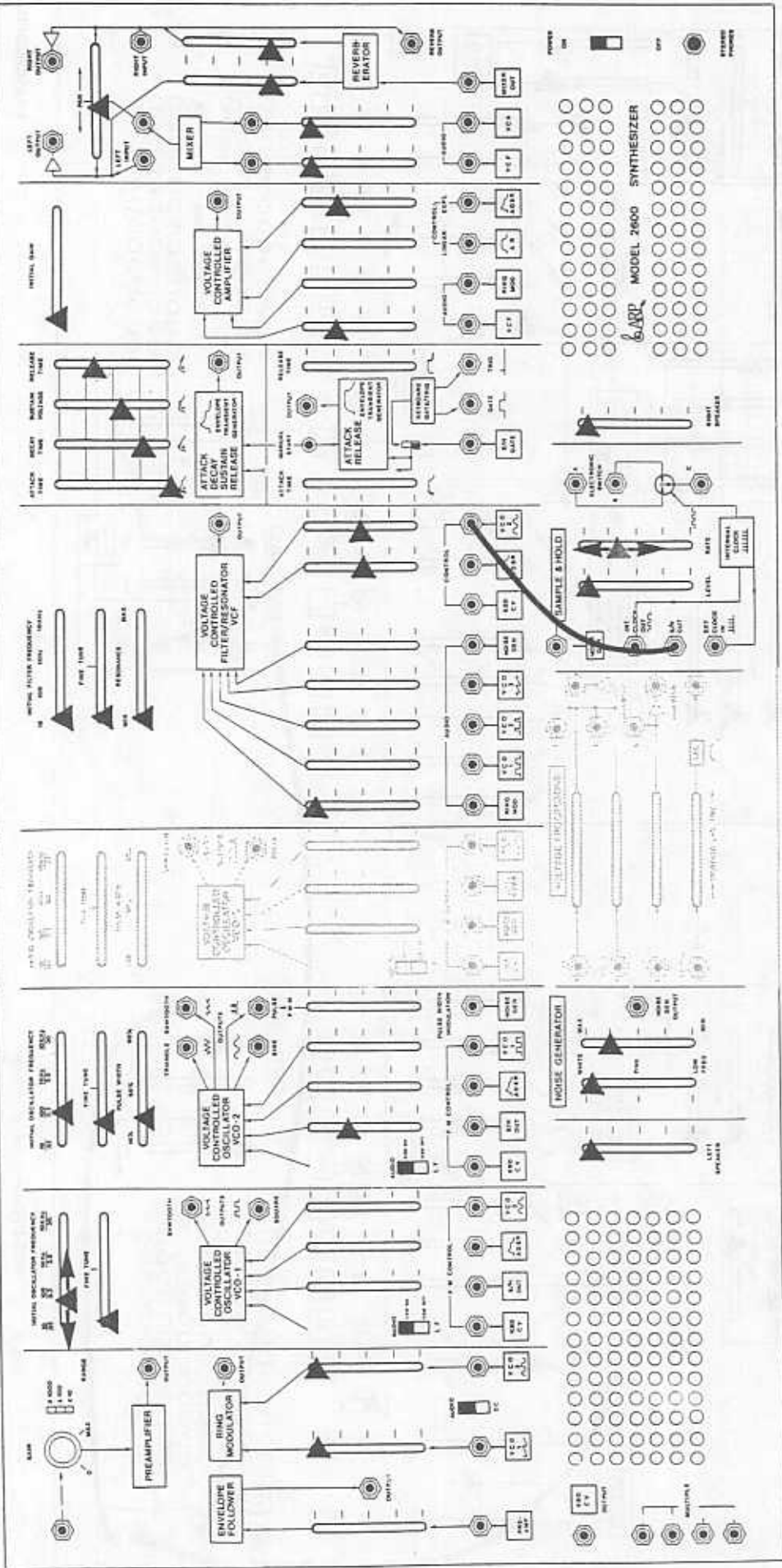

1 PATCHCORD

Adjust: VCO 1 frequency for pitch.  
S/H Rate for tempo.

PLAY KEY C2

# Cookin' Conga

# 46.

# Natural Sounds

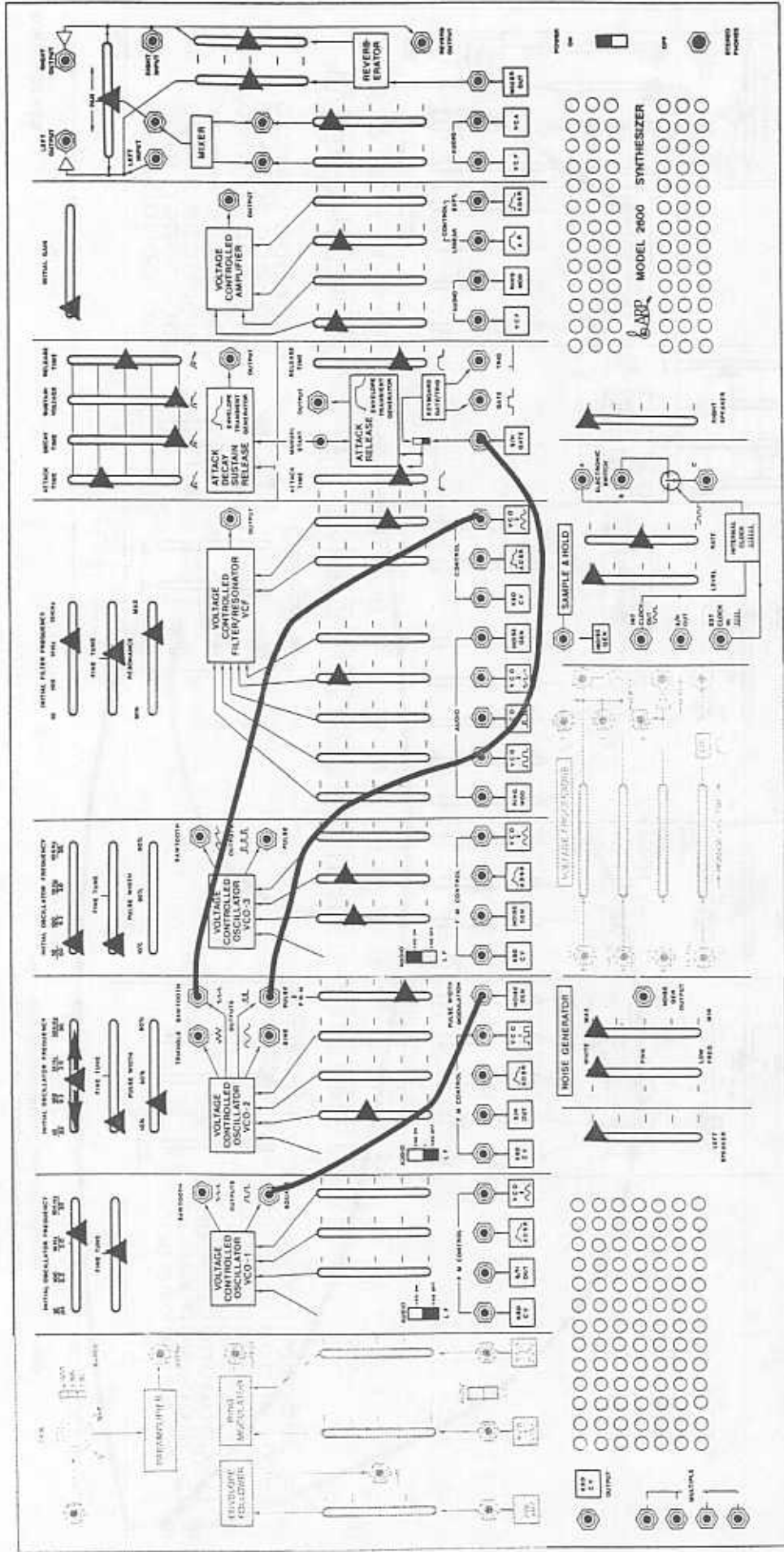

3 PATCHCORDS

Adjust VCO 2 frequency for different croak speeds.

48.

Frog Bog



ALPHEGPTM

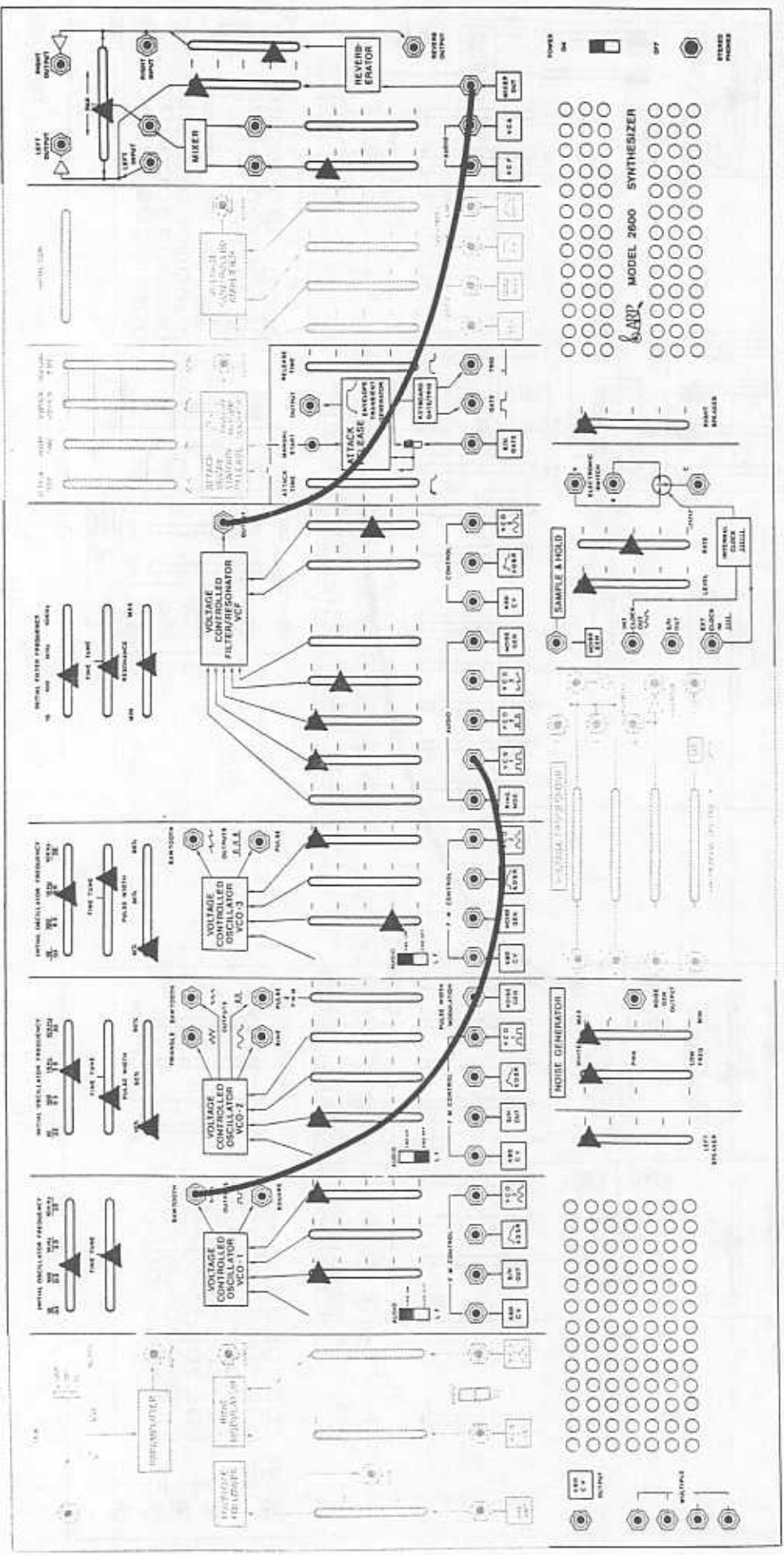

Change the 'pitch' of the patch by moving up and down the keyboard.

Fiddle with the filter settings.

2 PATCHCORDS

# Primeval Forest

# 50.

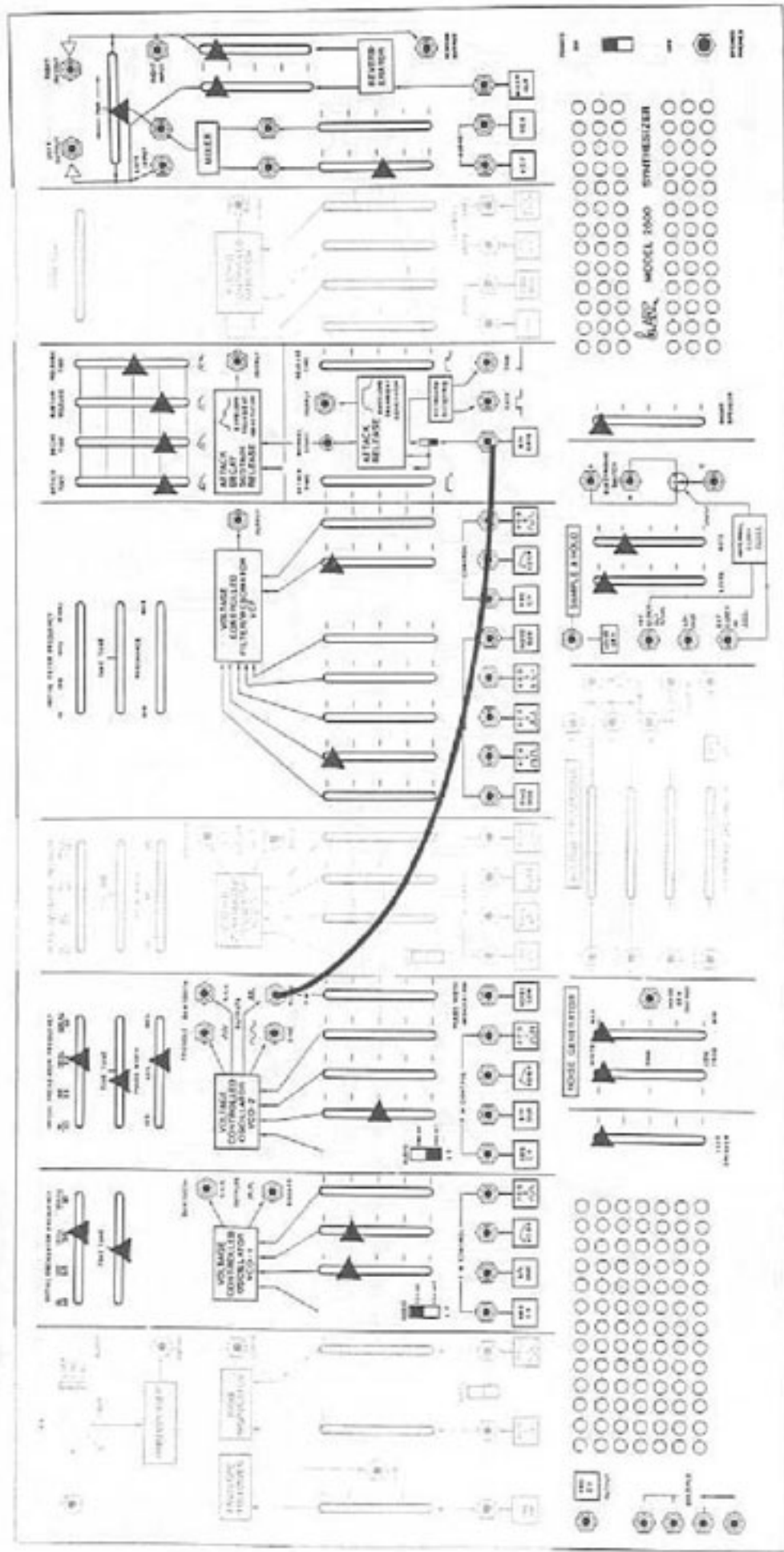

**OLD SCHOOL SOUND**  
[www.oldschool-sound.com](http://www.oldschool-sound.com)

!!!!!!! An exclusive free release !!!!!!!

SCAN by PASCAL.W -aka- "Analog Monkey"  
 Free manuals for Free Vintage addicts ! Creative use only

(\$\$ Not For Resale \$\$\$  
 (: Le bizness de ressources est un sport de ptizizis :)

Arboretum

51.

1 PATCHCORD



KEYBOARD RANGE: TOP 2 OCTAVES

VCO TUNING

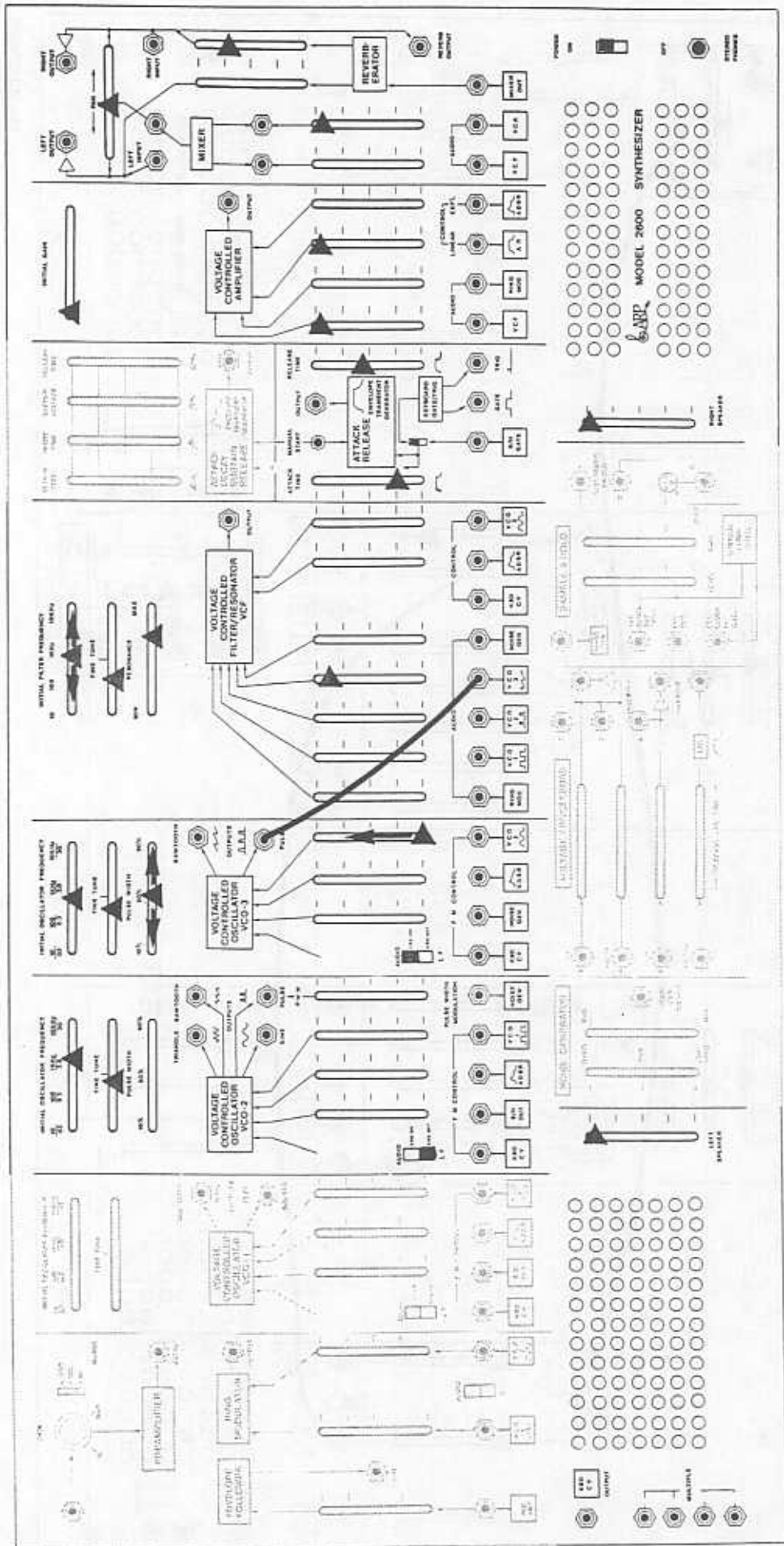

1 PATCHCORD

1. Tune VCO 3 to middle C.
2. Raise VCO 2 into VCO 3 and adjust VCO 2 frequency for tremelo speed.
3. Adjust VCO 3 Pulse Width and VCF frequency for desired timbre.

Soprano

52.



Clubbond Juniors

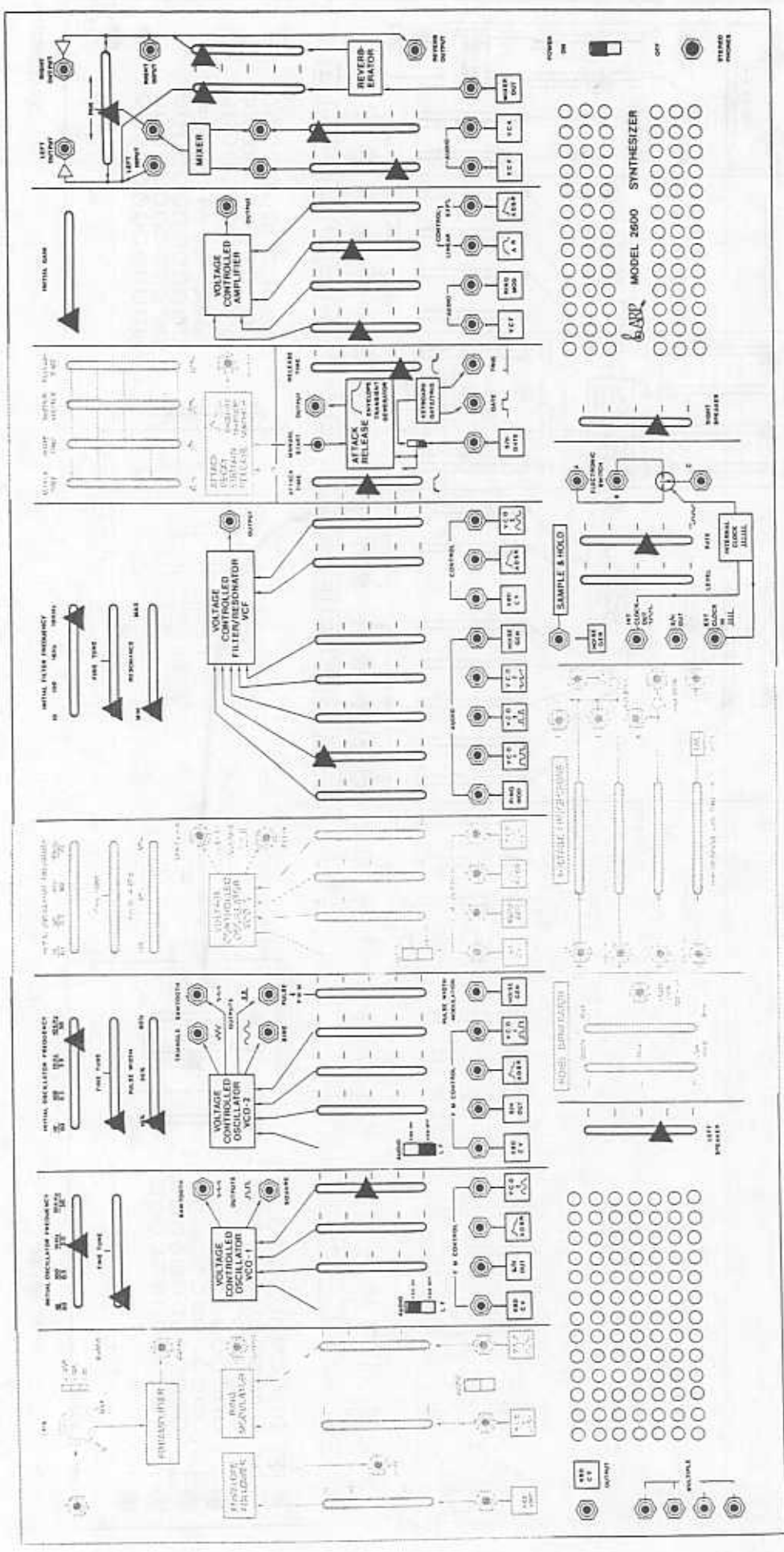

PLAY KEY C5

Cricket Colony

54.

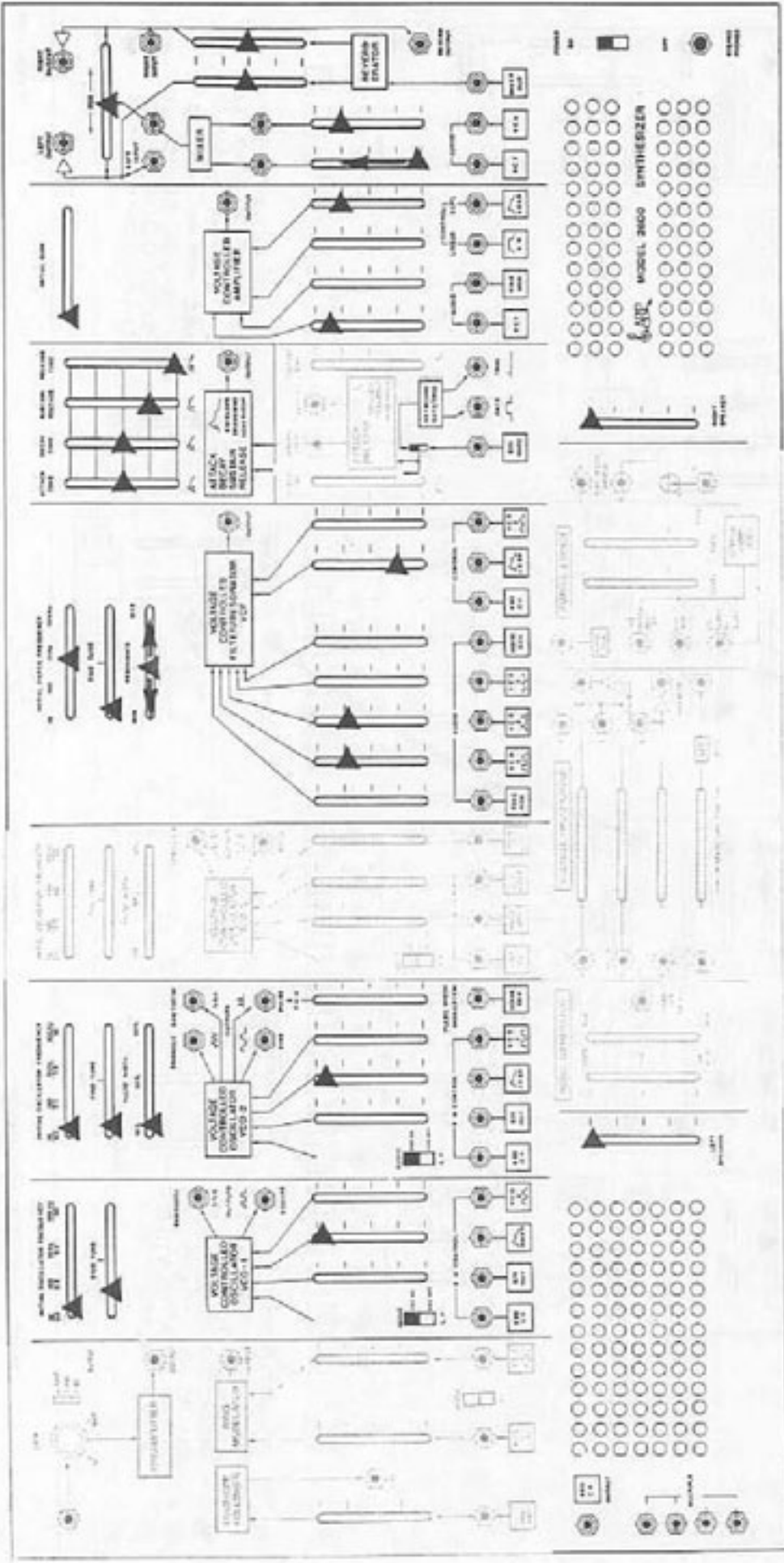

**PROSCHOOL-SOUND**  
[www.proschool-sound.com](http://www.proschool-sound.com)  
 !!!!! An exclusive free release !!!!!

**SCAN by PASCAL.W -aka- "Analog Monkey"**  
 Free manuals for Free Vintage addicts ! Creative use only  
 \$\$\$ Not For Resale \$\$\$  
 (: Le bizness de ressources est un sport de pitizis :)

Note: Best barks can be heard around Key C2  
 Raise VCF into Mixer for growl.

**Small Barking Mutt**

**56.**



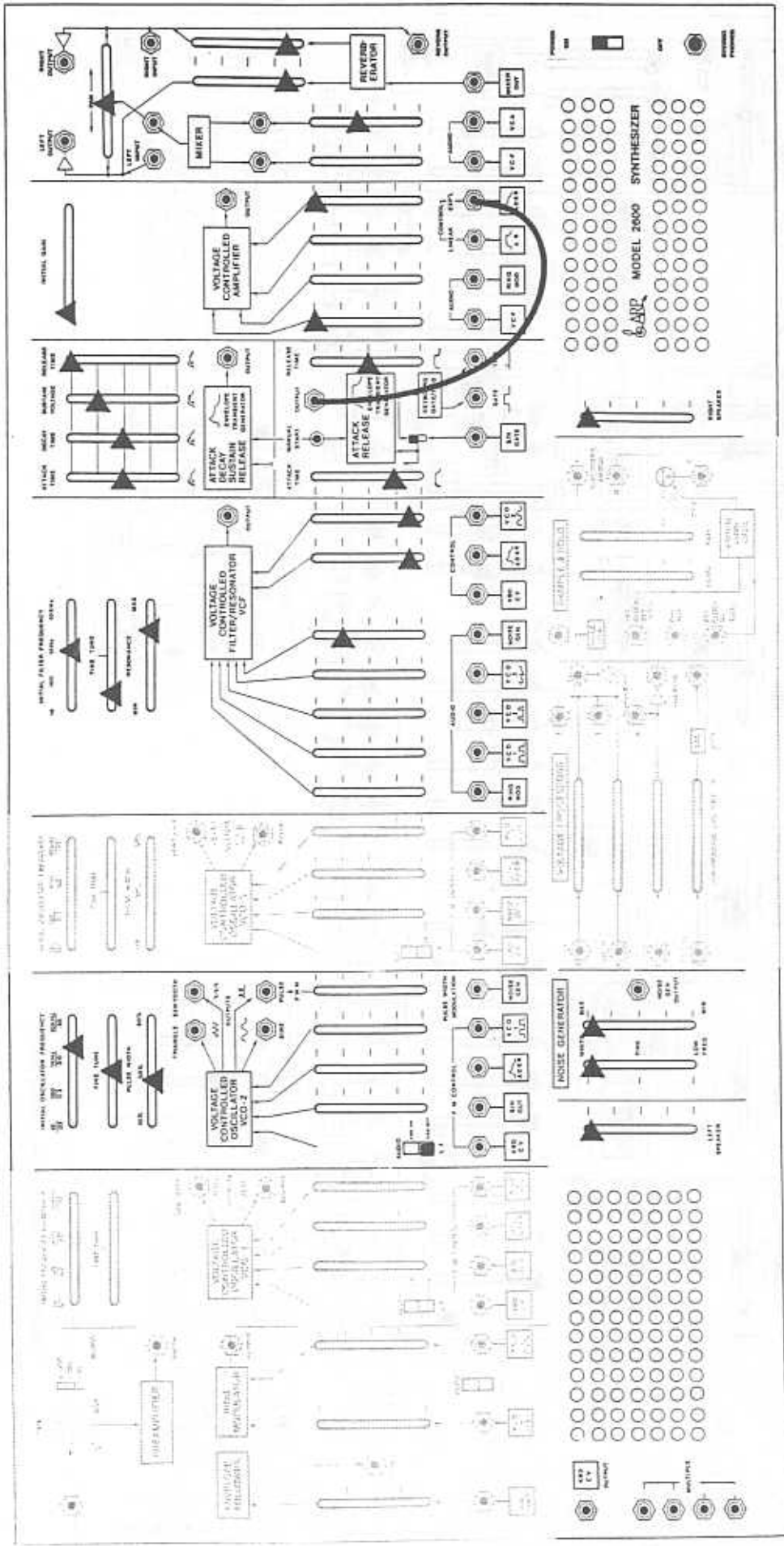

1 PATCHCORD

Mother Whistler

58.

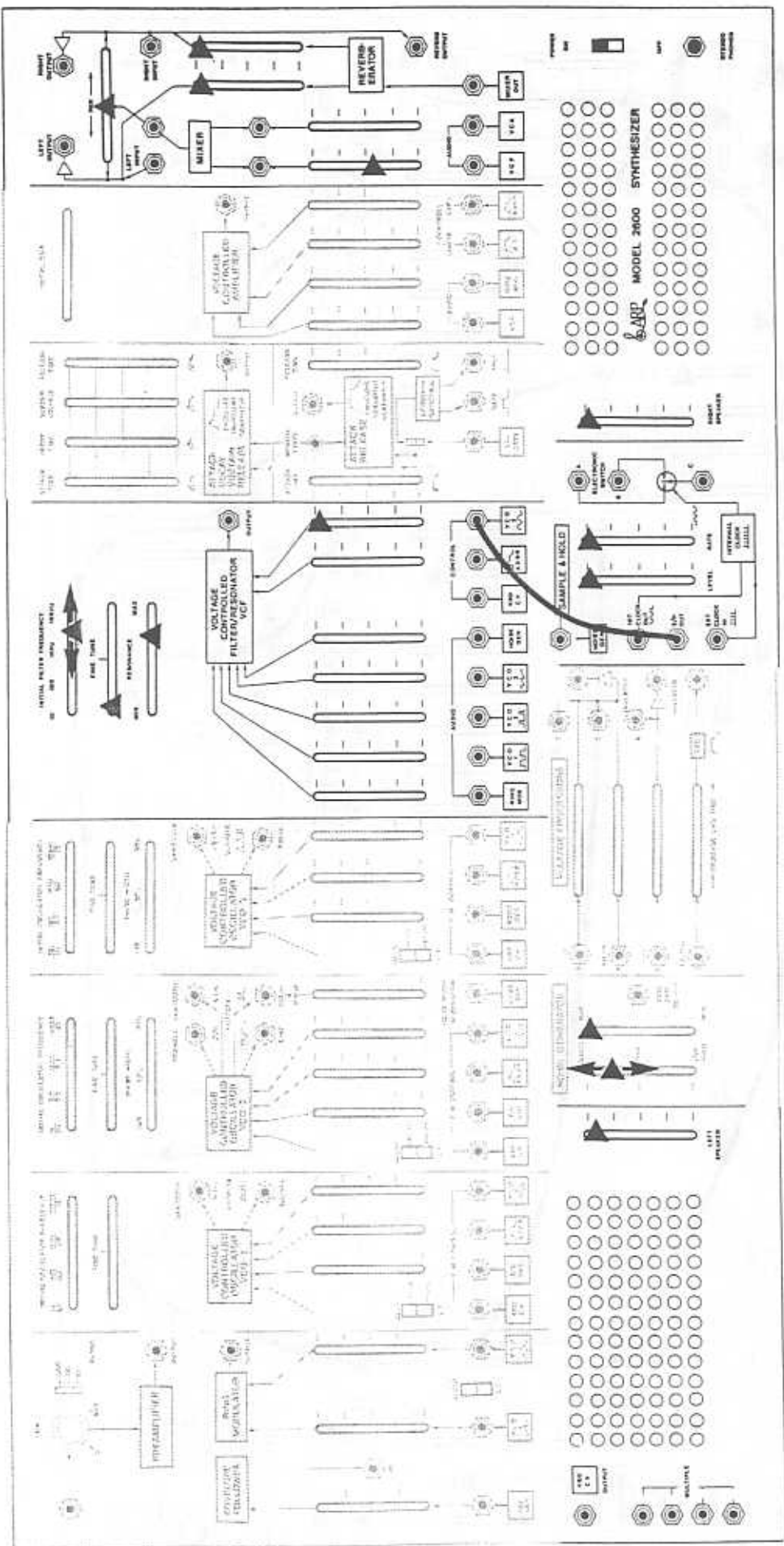

1 PATCHCORD

Adjust: VCF frequency and Noise color for desired effect.

# Water Drops

# 60.

KEYBOARD RANGE: BOTTOM 2 OCTAVES OR MANUAL START

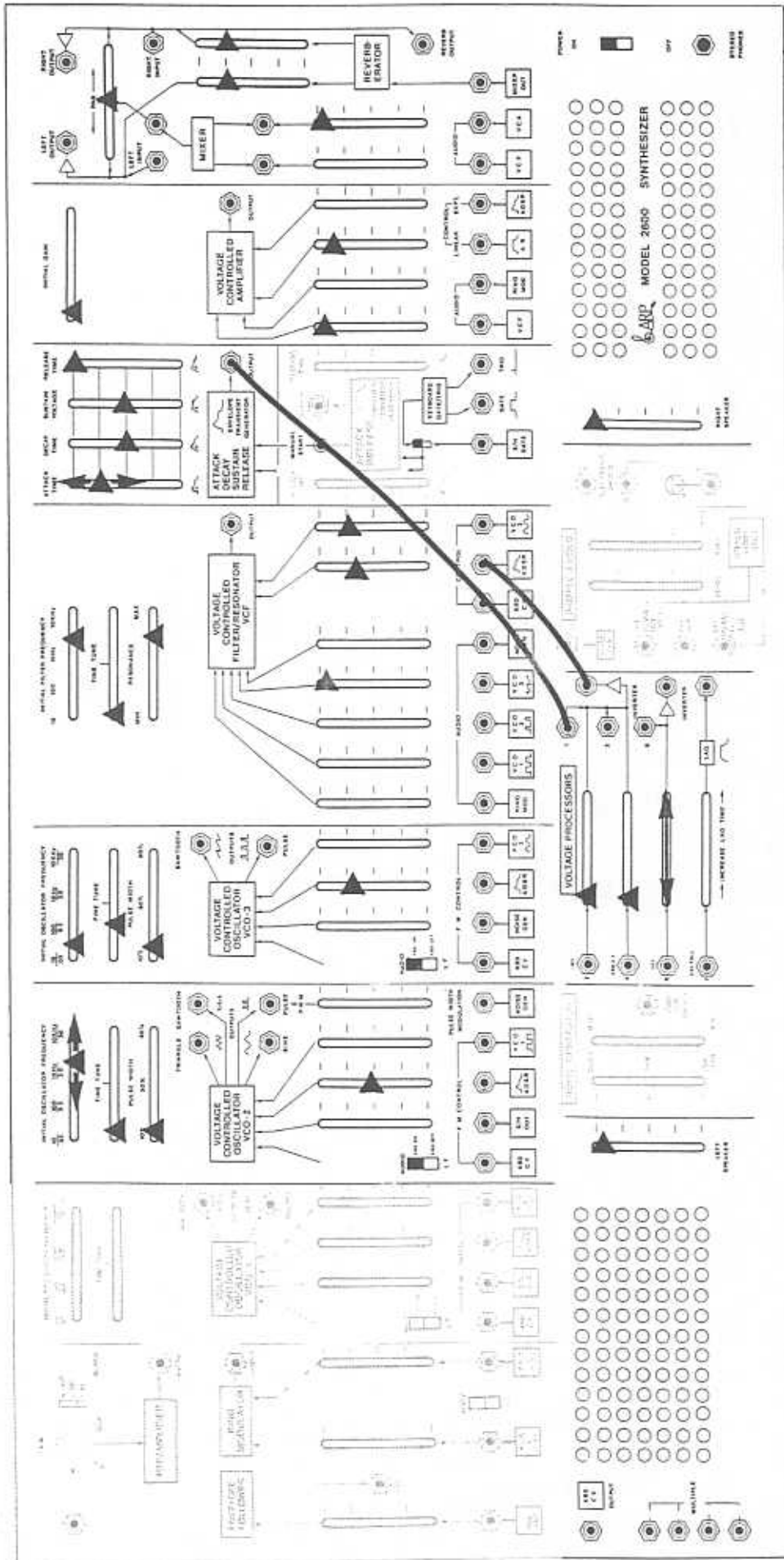

2 PATCHCORDS

Adjust: ADSR into VCF.  
 VCO 2 ~| into VCF for 'voice-like' texture.  
 VCO 2 frequency for different vowels.  
 Resonance.  
 Attack time on ADSR.

“Oh Yeah!”

# Arpeggios, Chords & Sequences



VCO TUNING



VCO 1 VCO 3 VCO 2

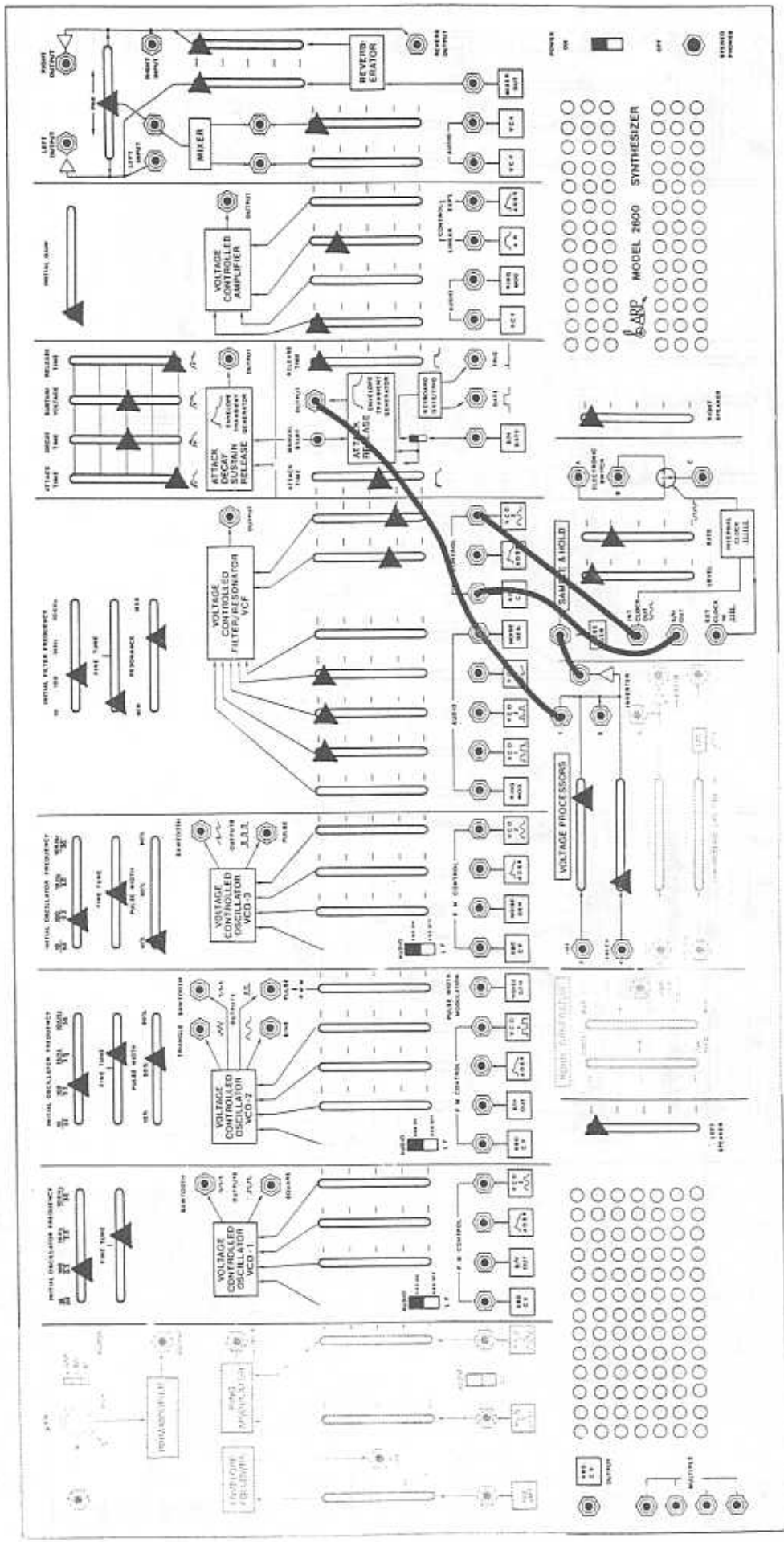

4 PATCHCORDS

Tune: VCO 1 to one octave below middle C.  
VCO 2 to middle C.  
VCO 3 to a fourth below middle C.

# Inverted ADSR Harmonic Arpeggio

# 63.

### VCO TUNING



VCO 2 VCO 3

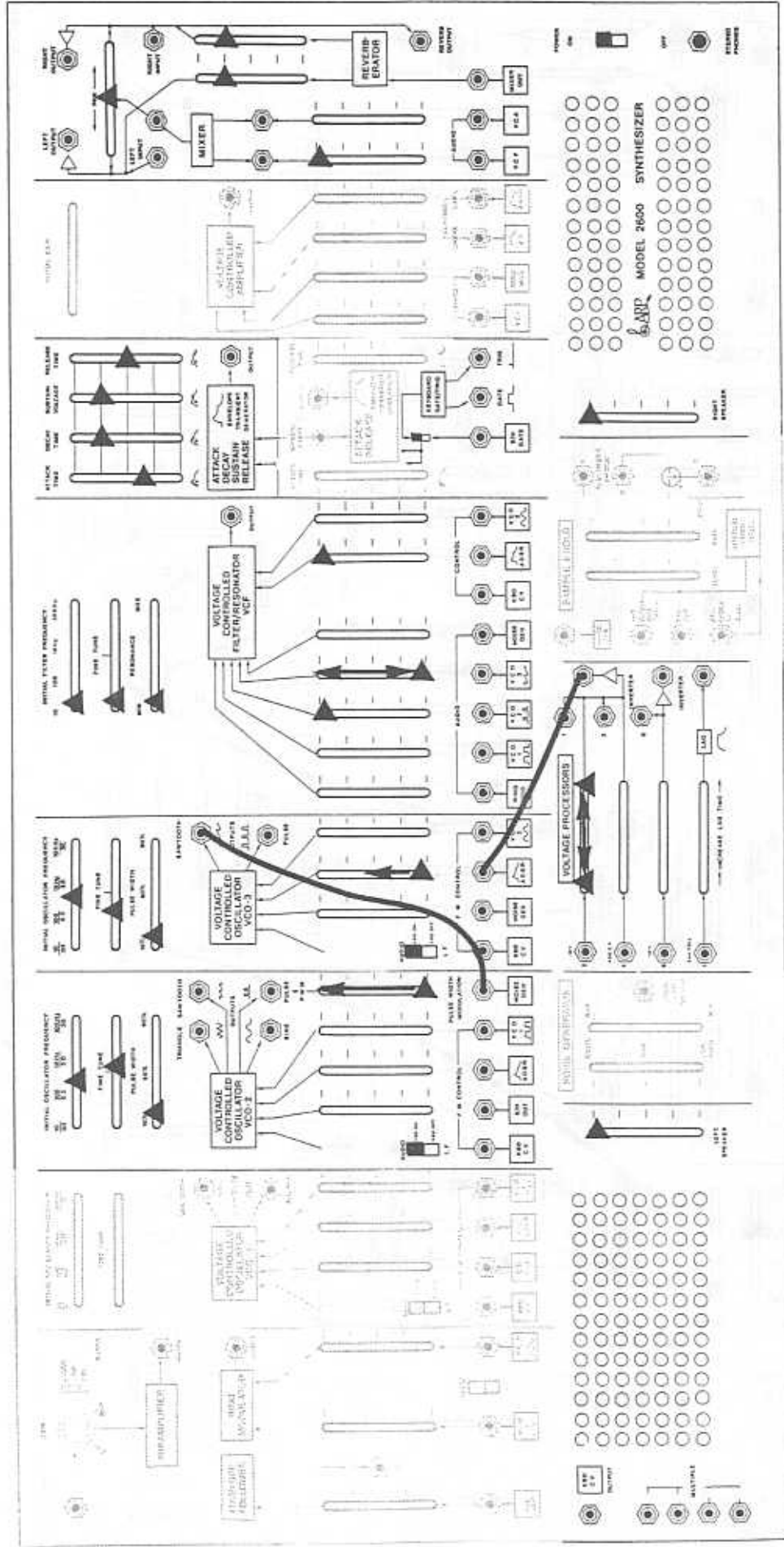

#### TONIC CHORD (I):

1. Tune VCO 2 to middle C.
2. Raise VCO 3 [---] into VCF and tune to a minor 6th above VCO 2 (C-A).
3. Close VCO 3 [---] and raise Pulse Width Mod slider fully into VCO 2.

#### SUBDOMINANT CHORD (IV):

4. Move Inverter slider fully to the right.
5. Raise I into VCO 3 until a new chord is heard.
6. Moving Inverter slider back and forth produces either I or IV chord.

2 PATCHCORDS

# Three-note Chord from Two VCOs

# 65.

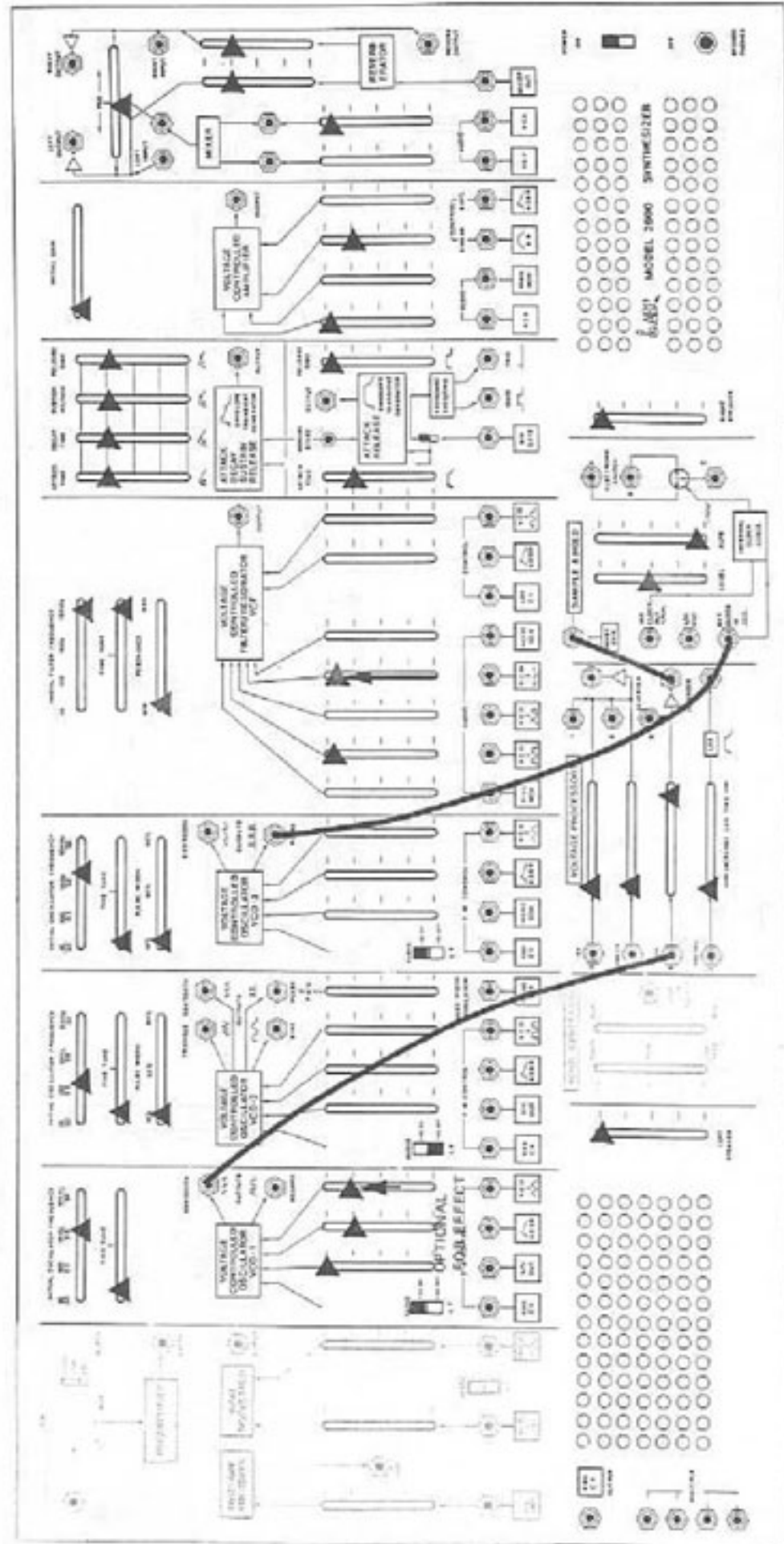

Be certain that the frequency of VCO 3 is above that of VCO 1

3 PATCHCORDS

**oldschool-sound.com**

!!!!!! An exclusive free release !!!!!!

**66.**

SCAN by PASCAL W -aka- "Analog Monkey"

Free manuals for Free Vintage addicts ! Creative use only

\$\$\$ Not For Resale \$\$\$

(: Le bizness de ressources est un sport de ptizis :)

# Inharmonic Sequencing





### VCO TUNING



VCO 1 with dummy plug  
VCO 1 without dummy plug

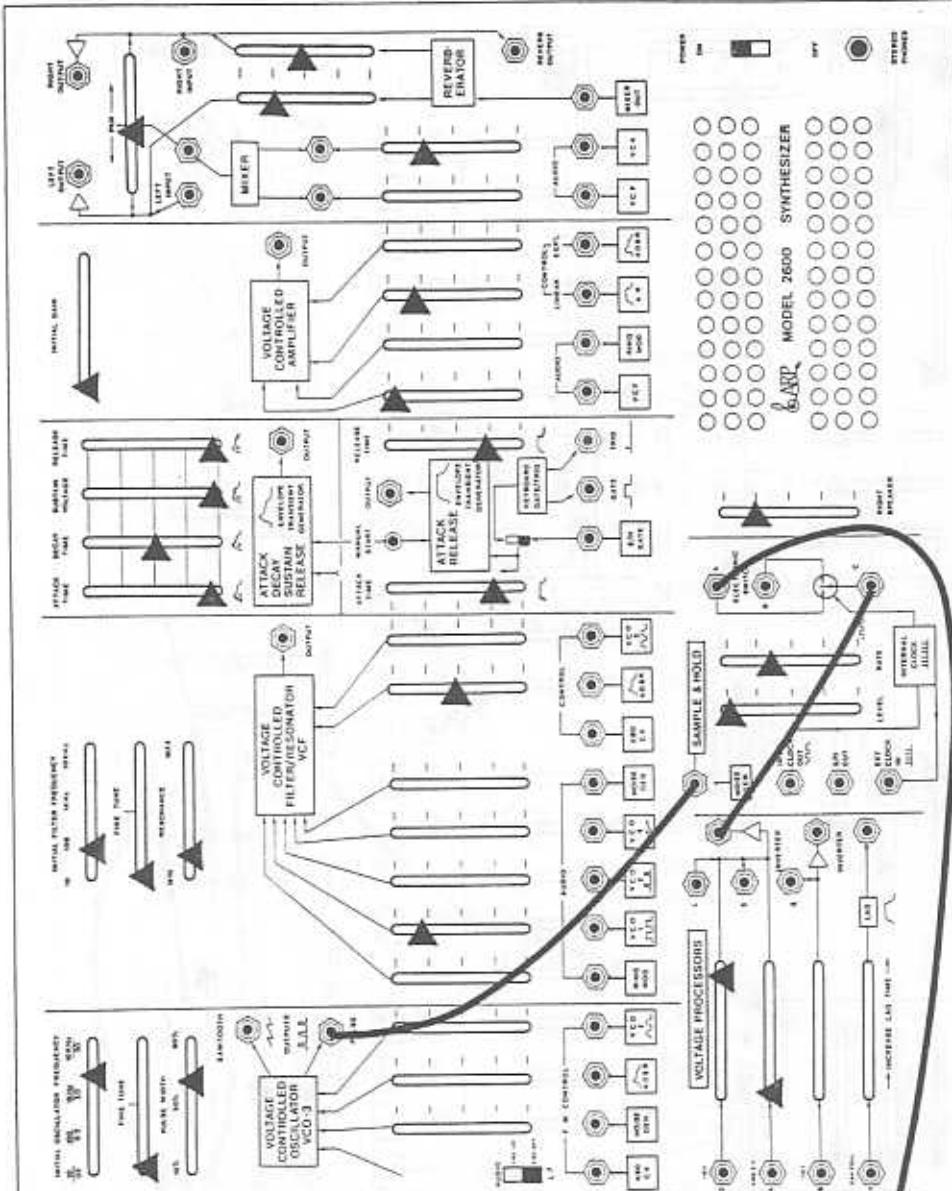
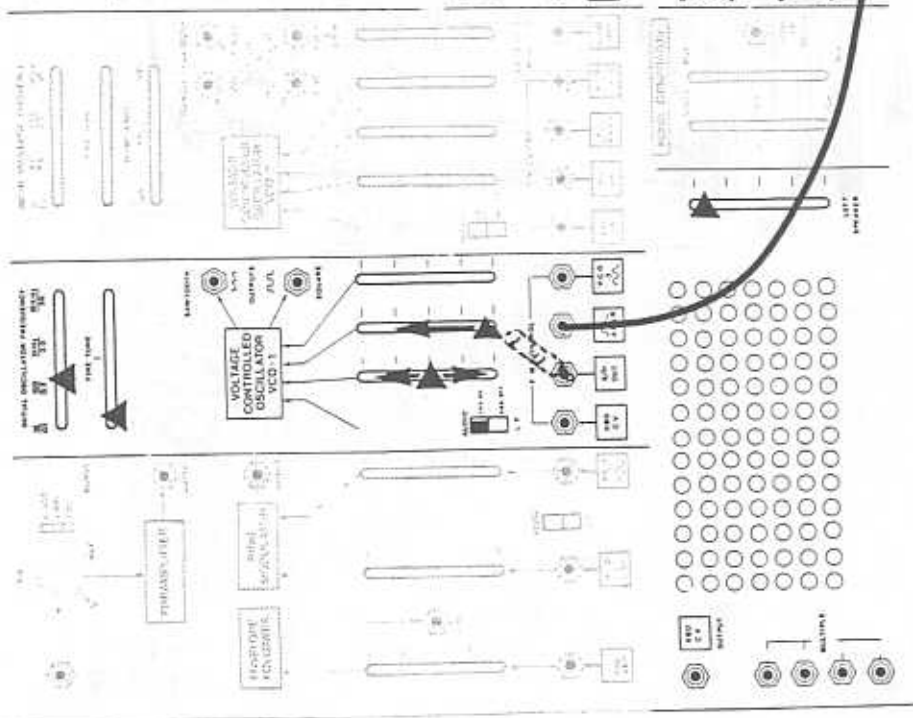

3 PATCHCORDS

- Tuning:
1. Tune S/H into VCO 1 to an octave interval.
  2. Insert dummy plug into S/H Jack at VCO 1 and raise  $\hat{S}/H$ , tuning to a fifth.
  3. Remove dummy plug.

# Random Select: Four-note Tunable Arpeggio

# 67.



# Sound Effects

!!!!!!! An exclusive free release !!!!!!!

SCAN by PASCAL W aka "Analog Monkey"

Free manuals for Free Vintage addicts ! Creative use only

\$\$\$ Not For Resale \$\$\$

(: Le bizness de ressources est un sport de pitizis :)

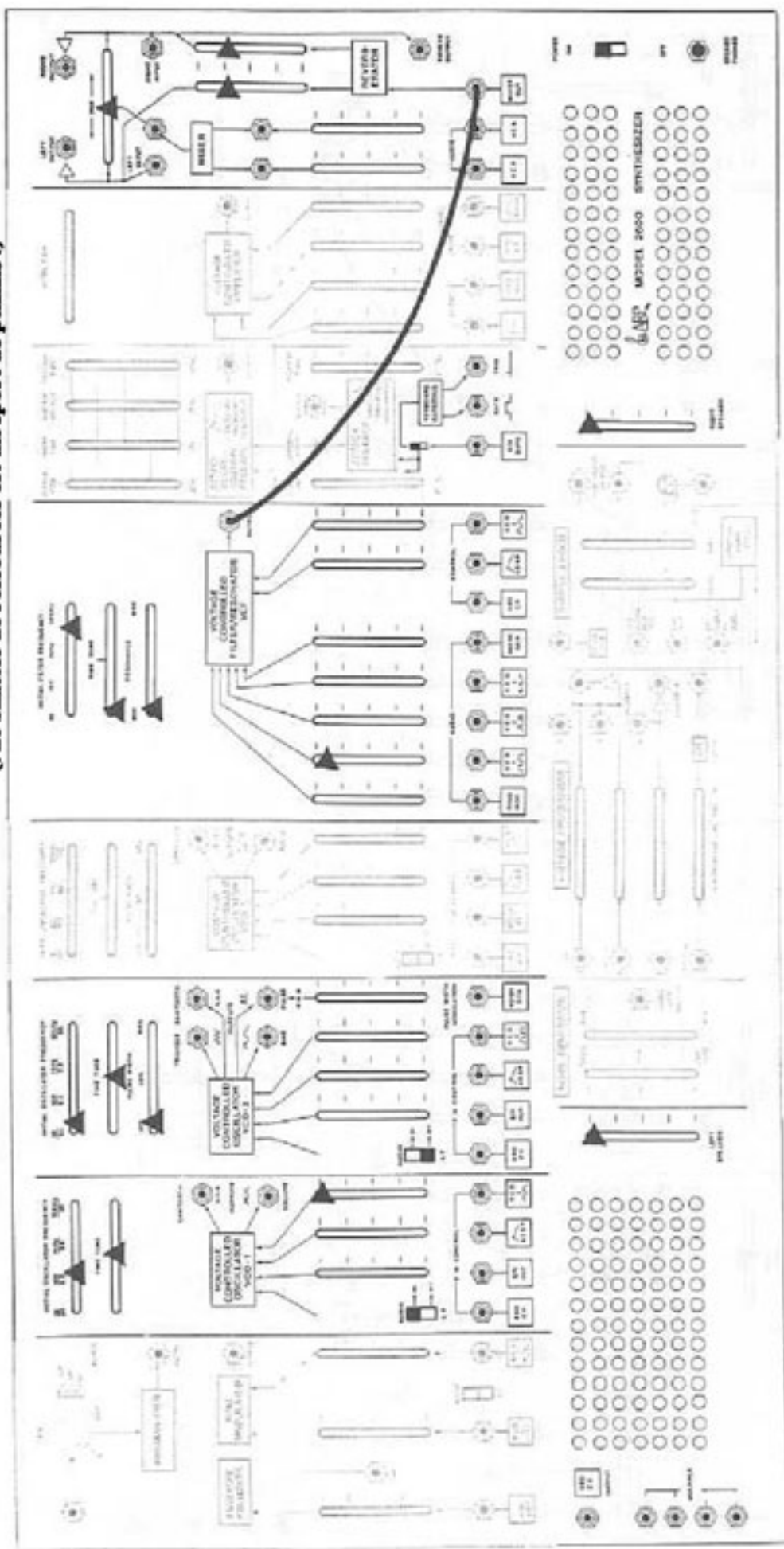

Switch VCO 2 Keyboard Switch on and off for horn blast.

PLAY KEY 03

1 PATCHCORD

# Firetruck Siren with Horn Blast

# 69.

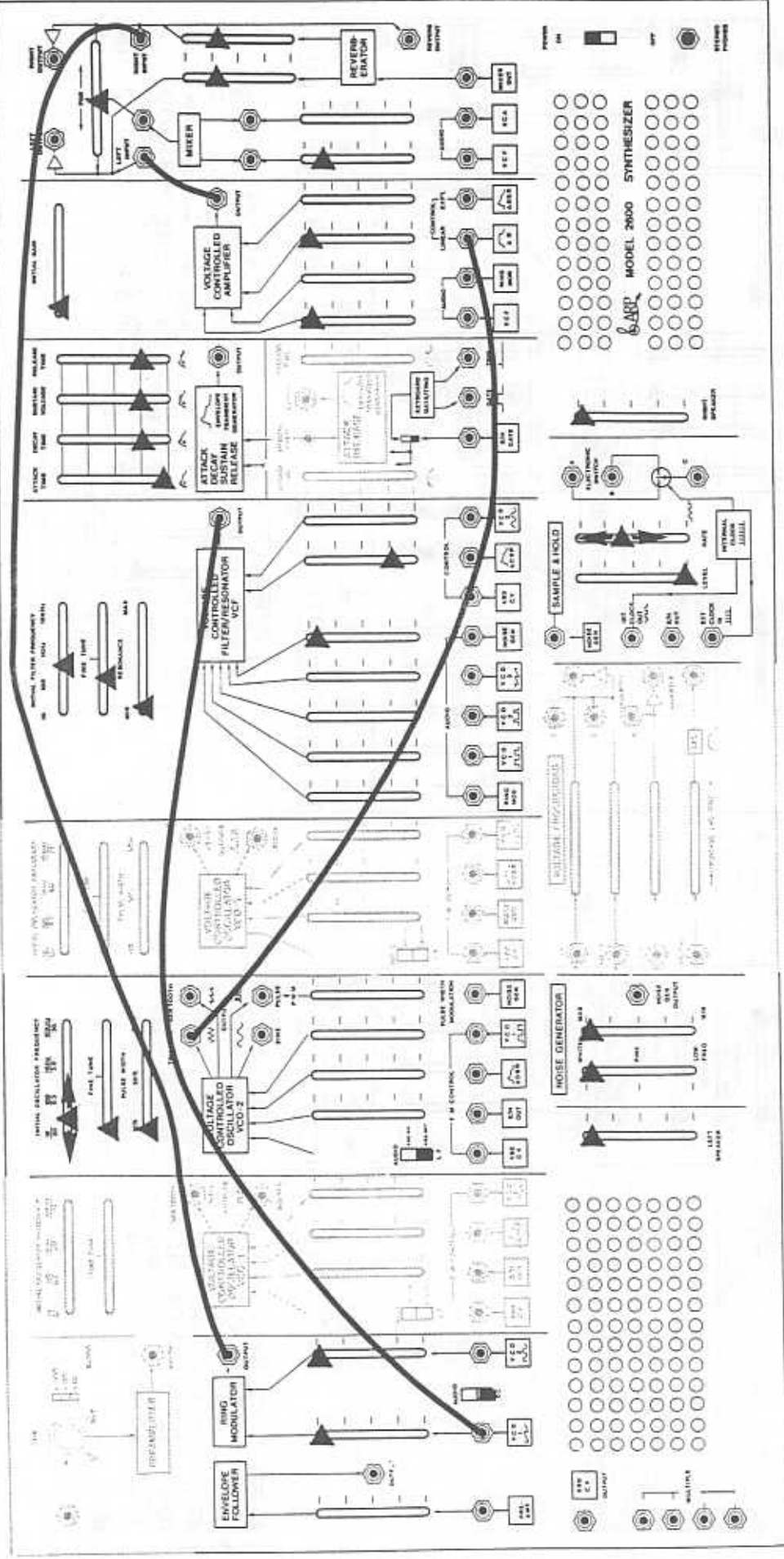

4 PATCHCORDS

Adjust: VCO 2 frequency for pan speed.  
S/H Rate for train 'chugga' speed.

PLAY KEY C4

# Panning Freight Train

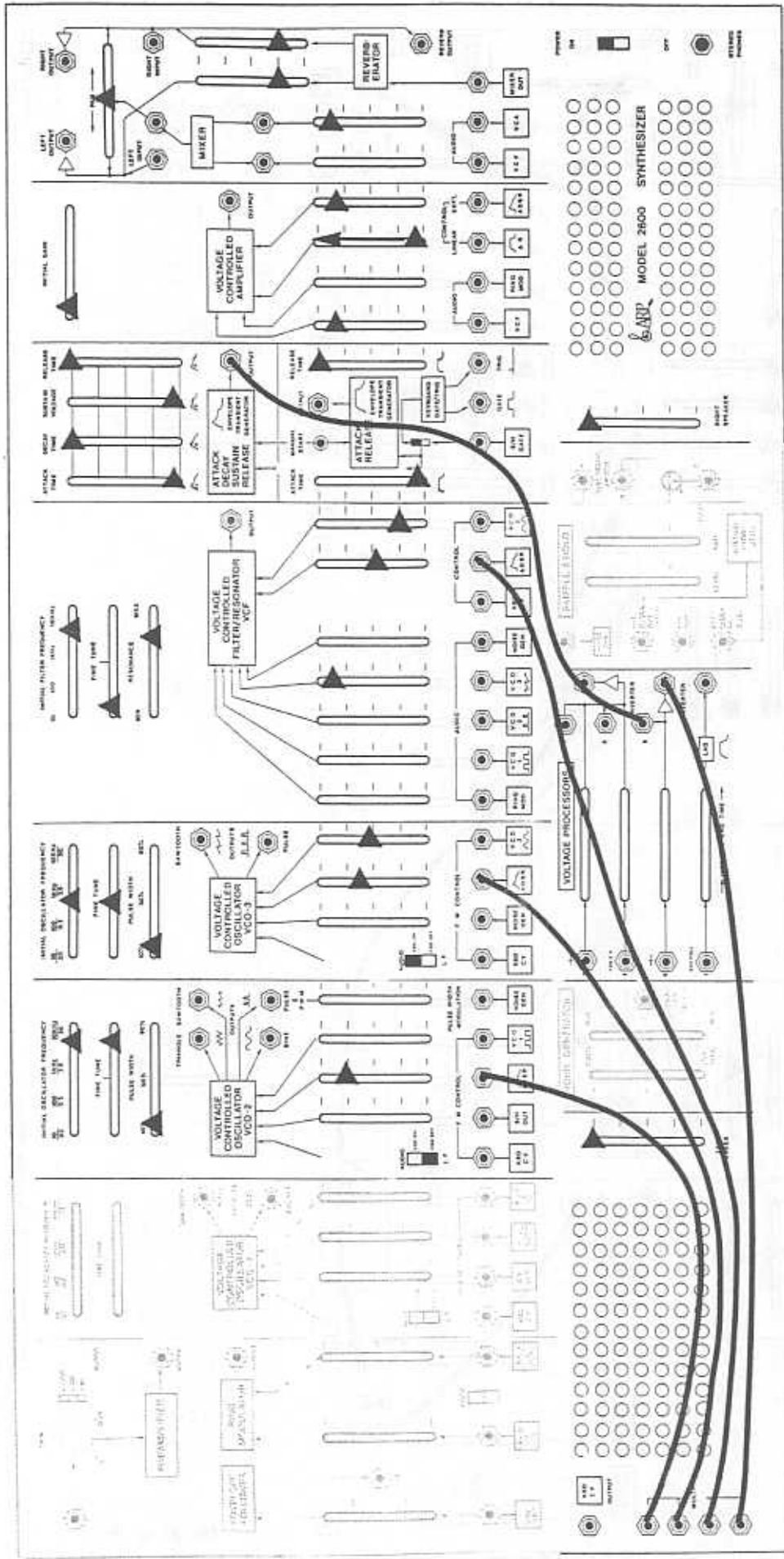

Raise AR into VCA for longer Boing.

5 PATCHCORDS

Boing!

73.

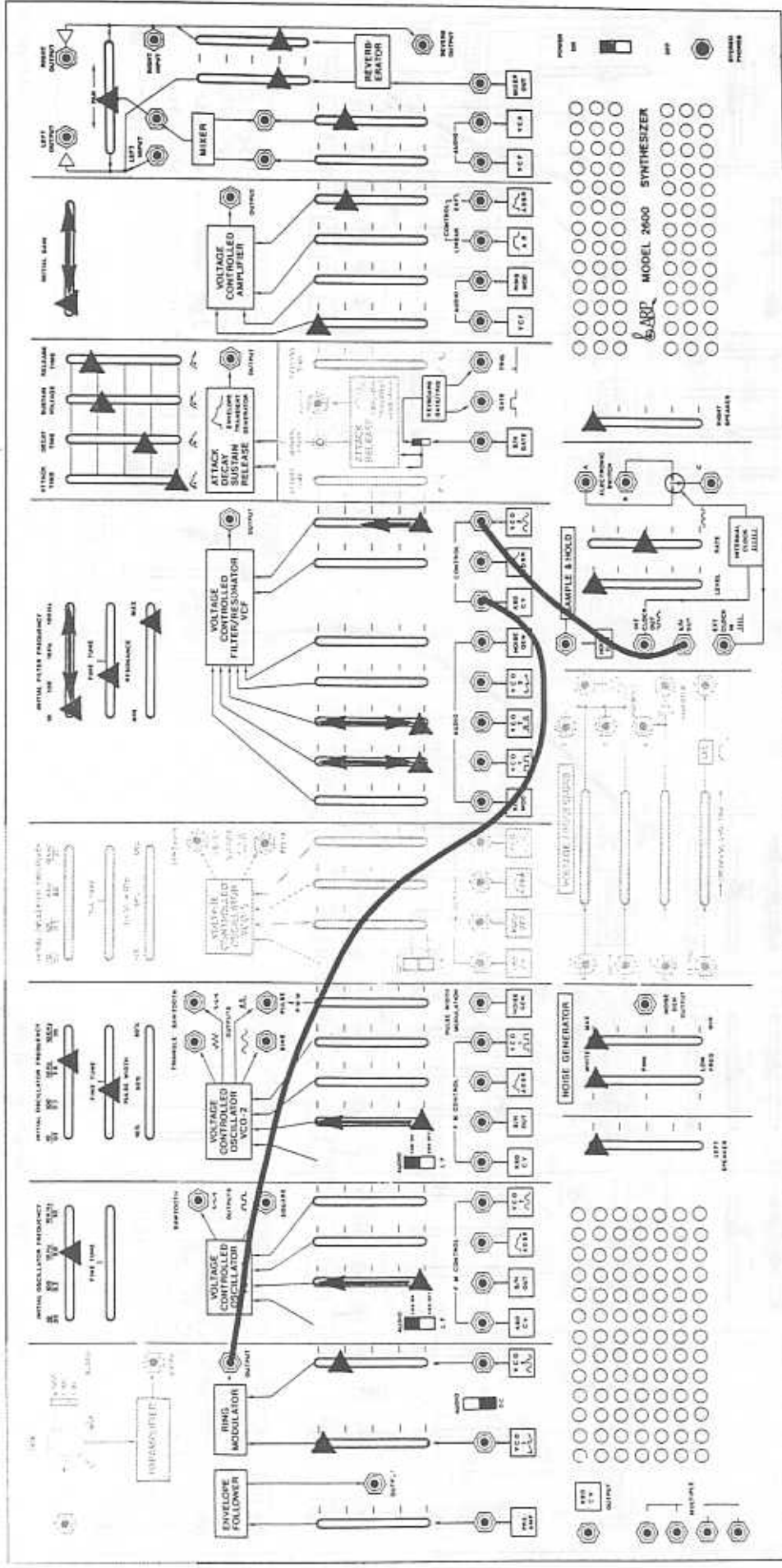

2 PATCHCORDS

1. Open VCF and VCA
2. Raise VCO 1 and 2 into VCF and Tune to unison.
3. Close VCF and VCA. Close VCO 1 and 2 at VCF
4. Raise: S/H into VCO 1 and 2 fully.  
Control slider at VCF as shown.
5. Switch to S/H GATE.

# Assorted Splits & Sproings

# 75.

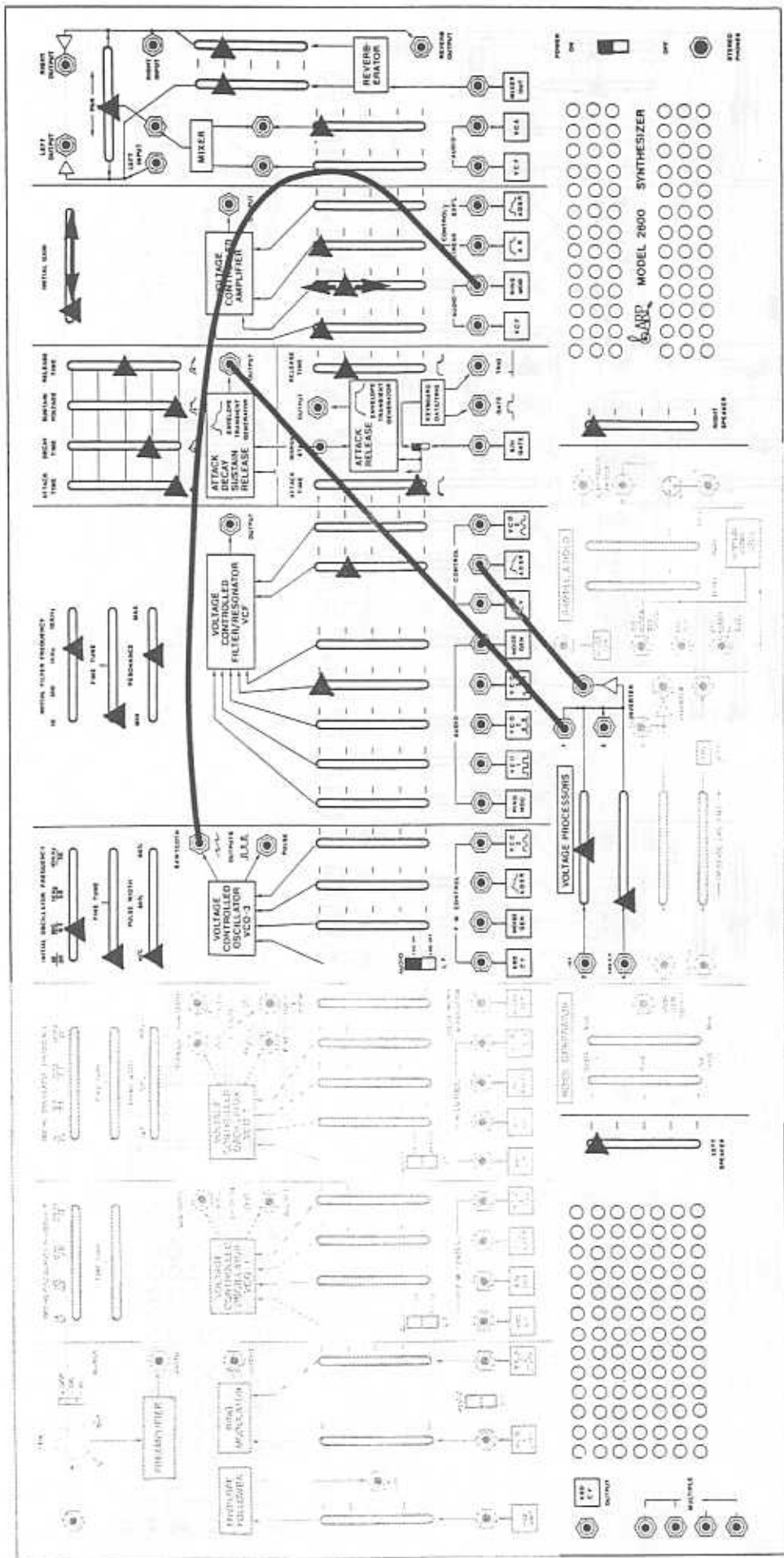

1. Open VCA —
2. Adjust VCO 3 gain into VCA for minimum volume.
3. Close VCA —

3 PATCHCORDS

# “Pwee” or Synthesized High-pass Filter 77.

# Advanced Applications

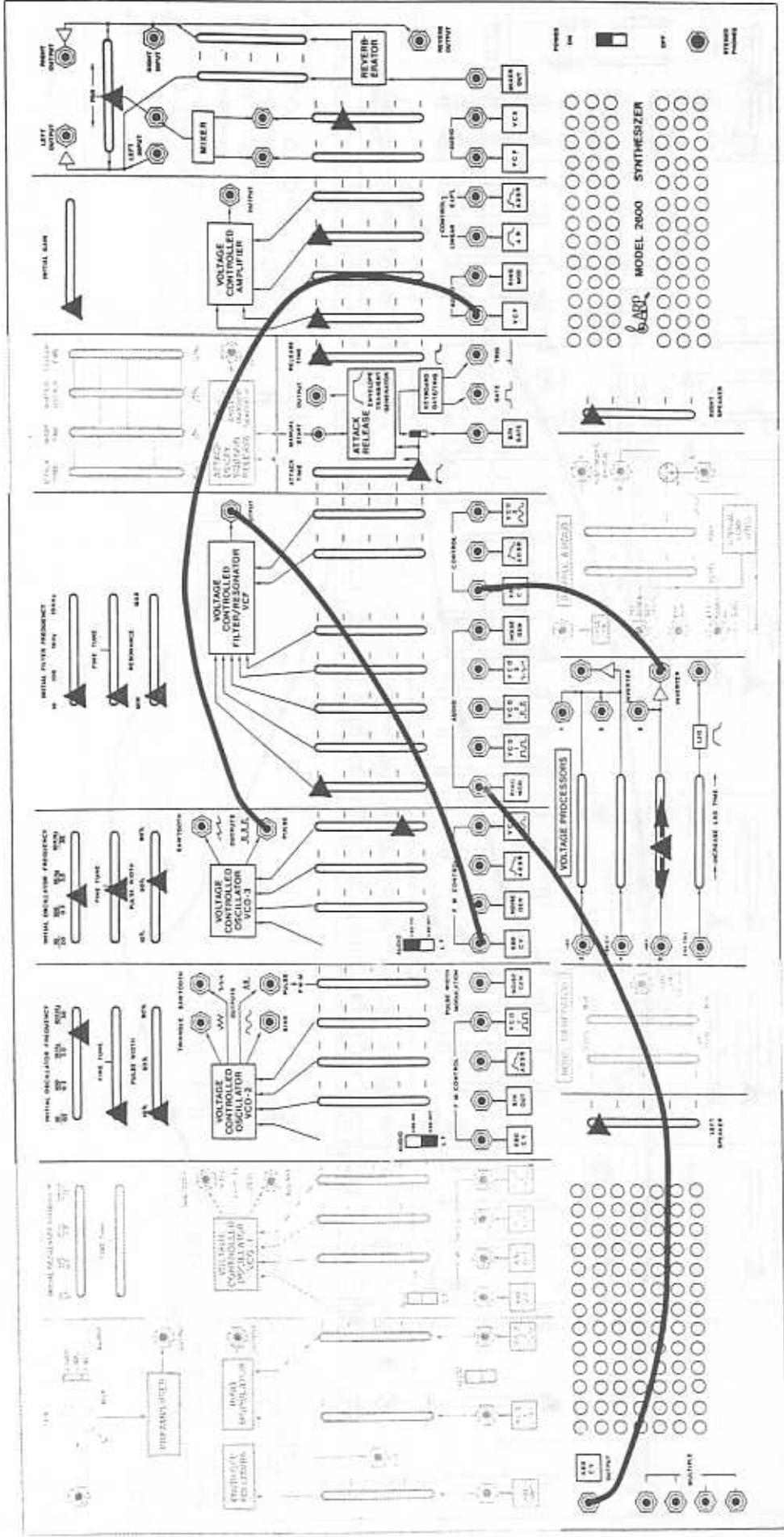

Adjust Inverter for 'glide time'.

4 PATCHCORDS

# Ultraglides with Release Memory 79.



!!!!!! An exclusive free release!!!!!!  
**SCAN by PASCAL.W -aka- "Analog Monkey"**  
**Free manuals for Free Vintage addicts ! Creative use only**  
**\$\$\$ Not For Resale \$\$\$**  
 (: Le bizness de ressources est un sport de ptizids :)

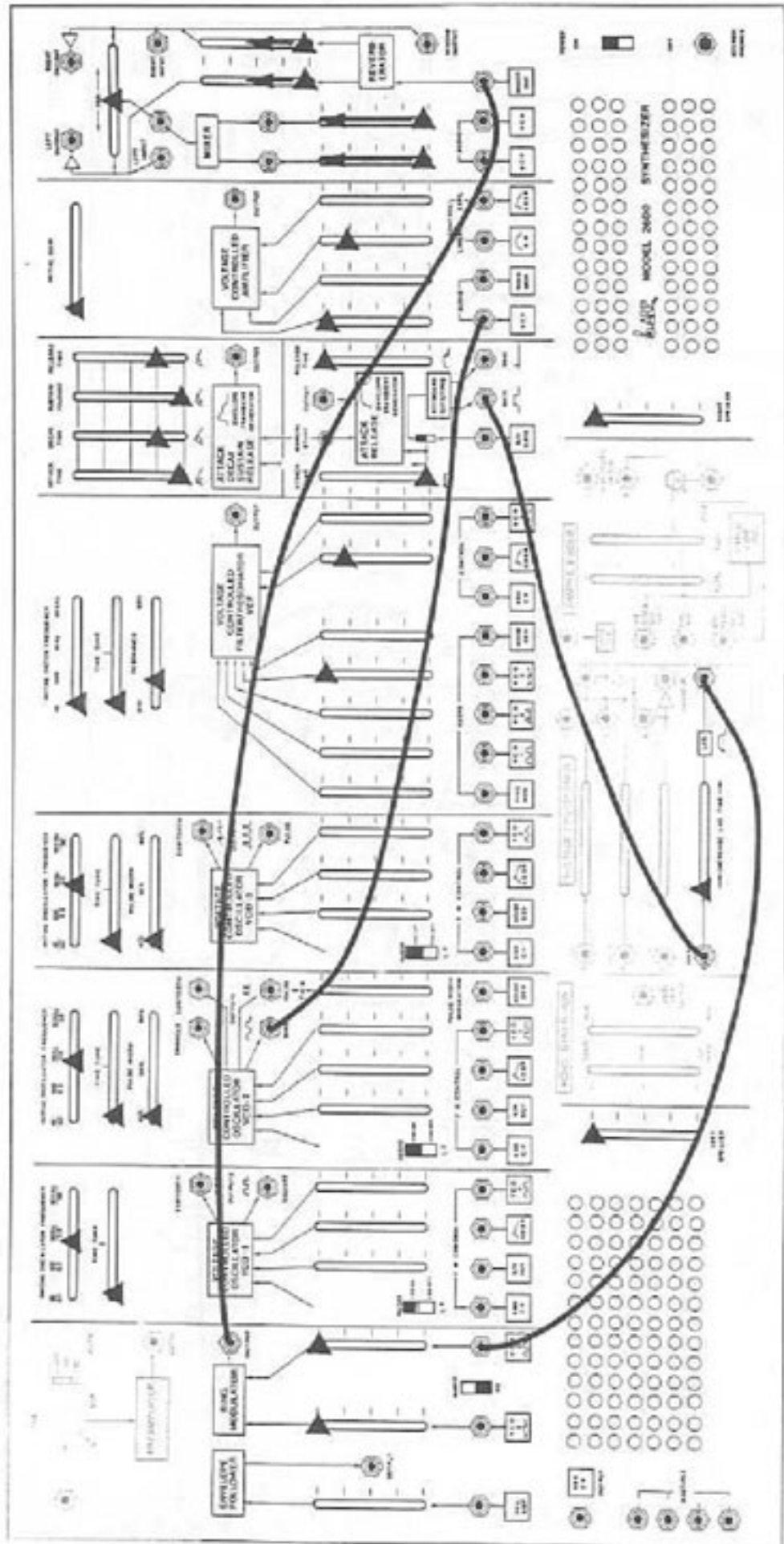

Tune Oscillators as desired.  
 Balance volume at arrows.

4 PATCHCORDS

# Trio: Three Separate Envelopes & Timbres 80.



DAWSON ENGINEERING

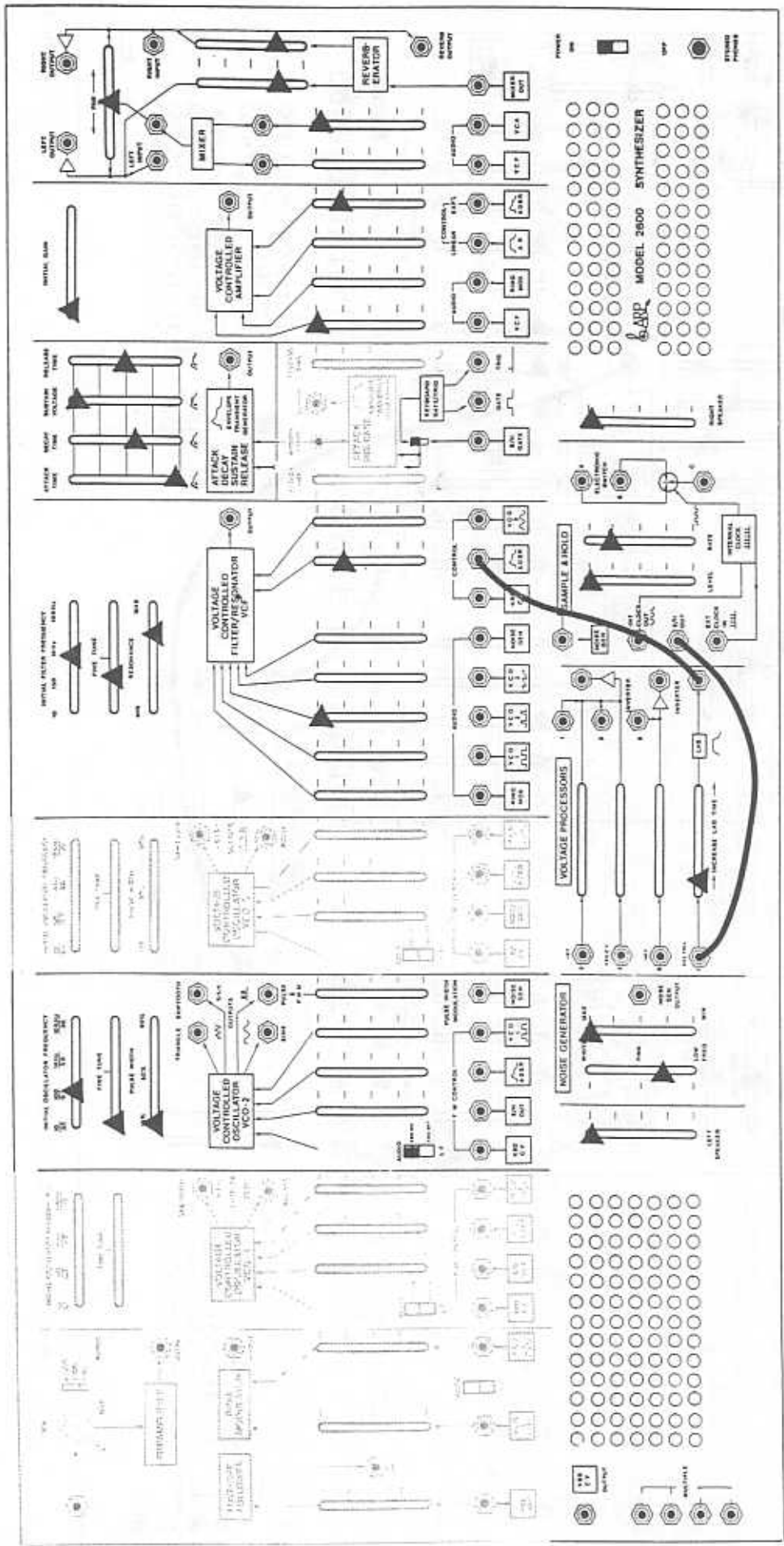

6-BARR MODEL 2800 SYNTHESIZER

2. PATCHCORDS

Lagged S/H to Filter

81.

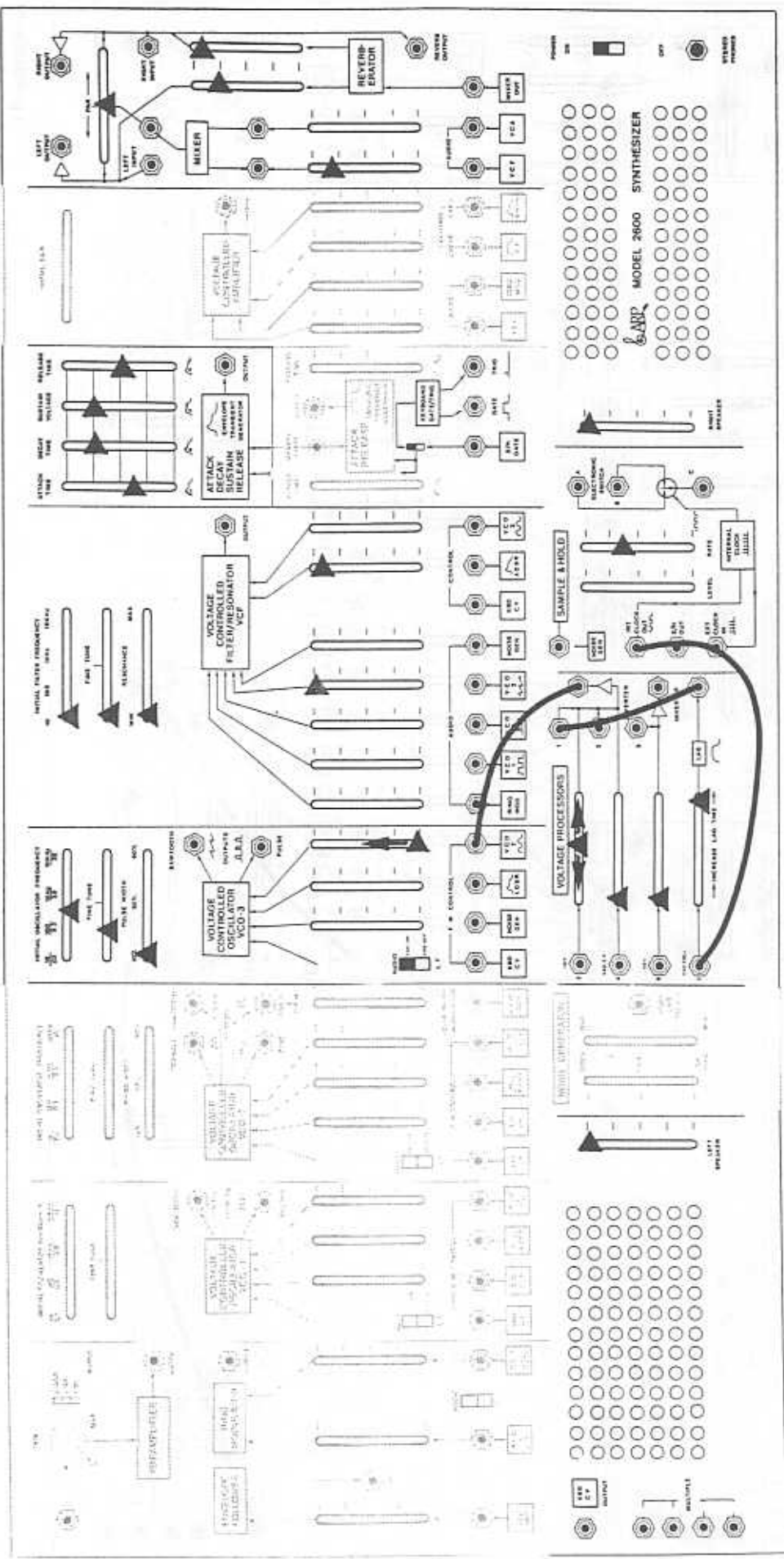

Adjust: Inverter into VCO 3 for fine tuning and vibrato depth.  
S/H Rate for vibrato speed.

3 PATCHCORDS

# Basic Vibrato from Internal Oscillator 83.

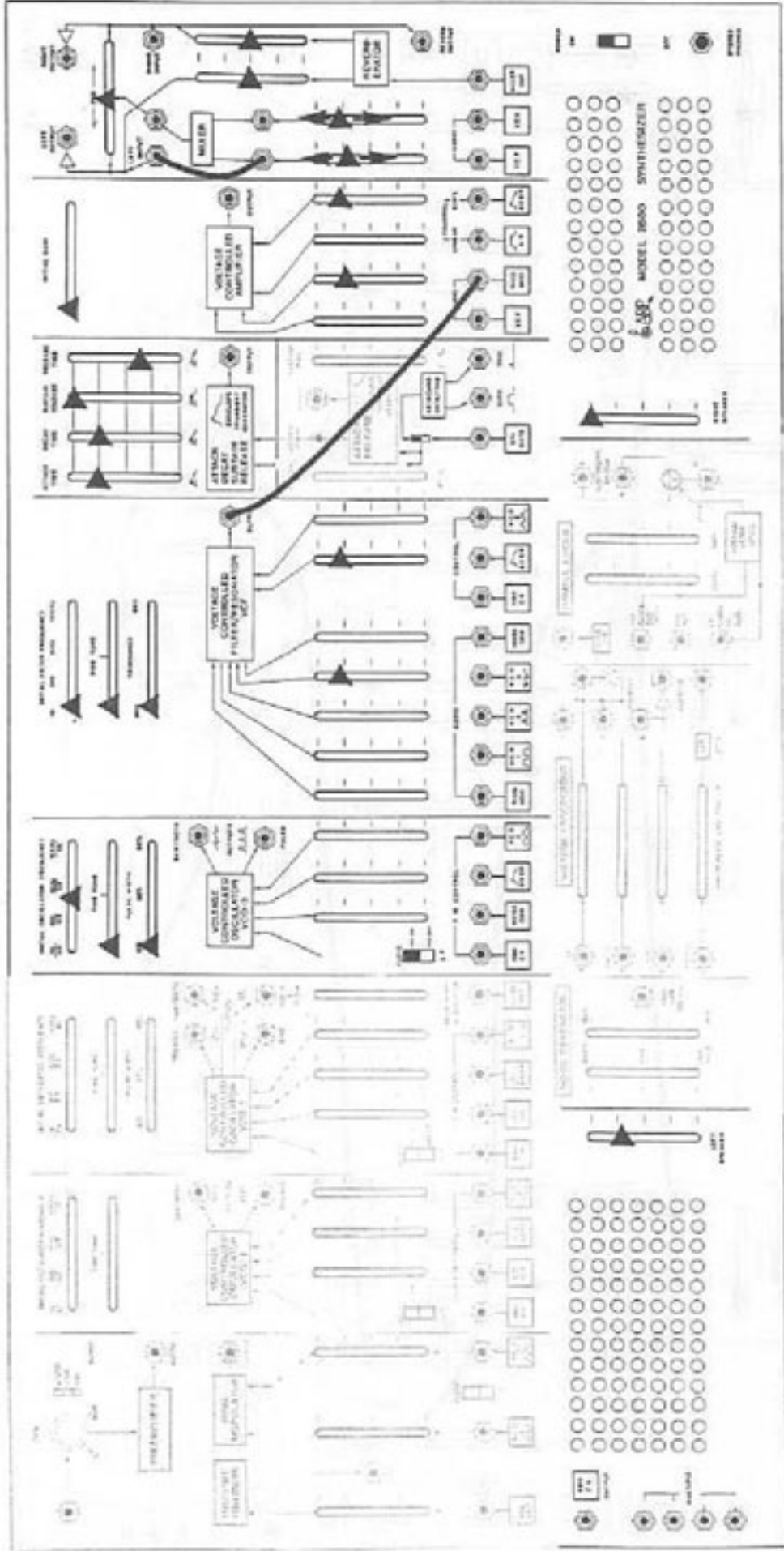

2 PATCHCORDS

**oldschool-sound.com**  
 An exclusive free release!!!!

Free manuals for Free Vintage addicts ! Creative use only  
 (\$ Not For Resale \$\$\$  
 (: Le bizness de ressources est un sport de ptizizis :)

1. Hold down any key.
2. Adjust VCF and VCA Mixer sliders for minimum volume in left speaker.
3. Adjust ADSR sliders for speed and position of pan.

ADSR Pan

85.

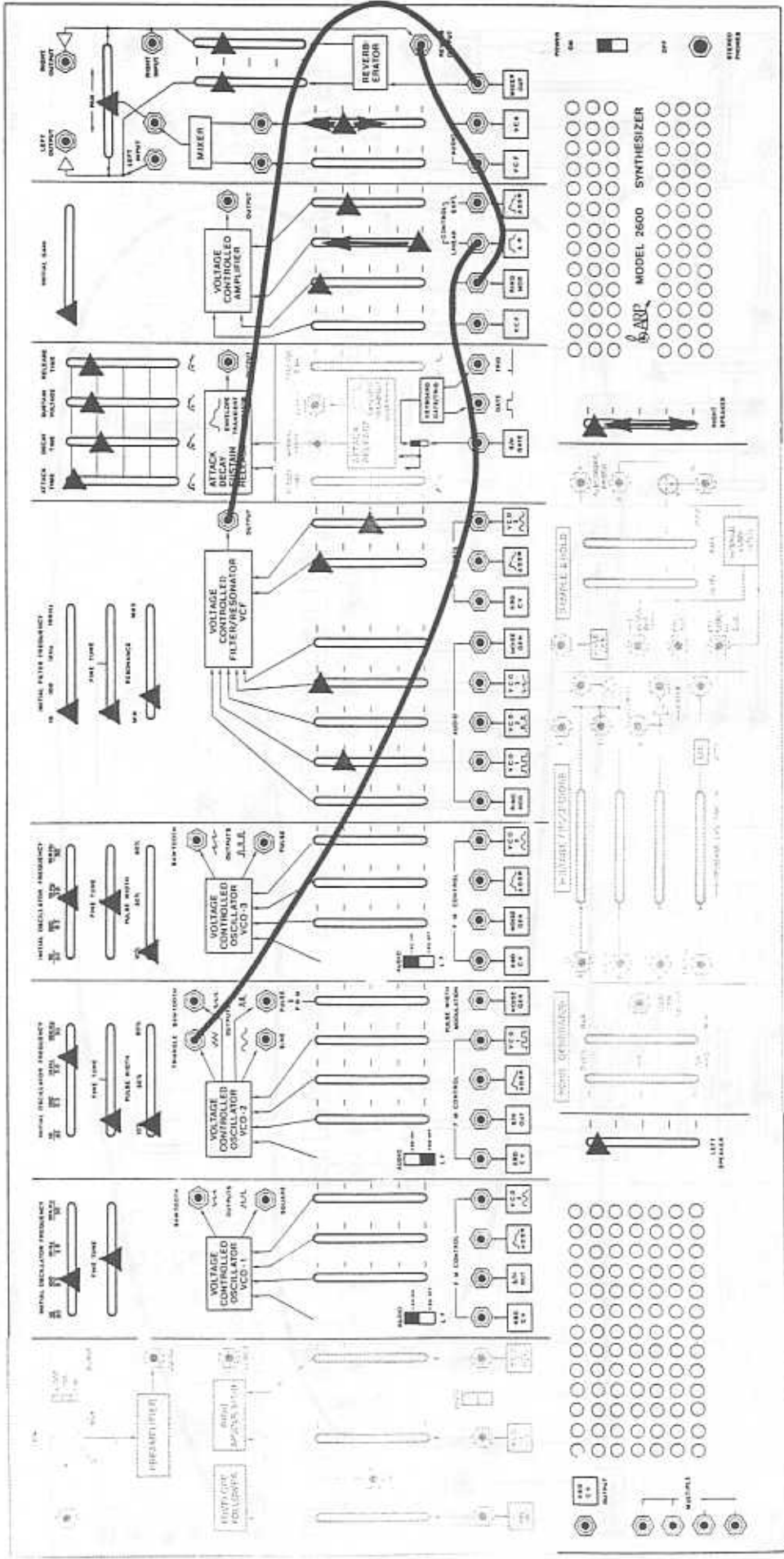

3 PATCHCORDS

1. Tune VCO 1 and 3 as desired.
2. Close right speaker /
3. Press any key and adjust VCA into Mixer for minimum volume in left speaker.
4. Open right speaker / and raise Linear Control into VCA.
5. Adjust VCO 2 frequency for pan speed.

# Auto-pan with Reverb

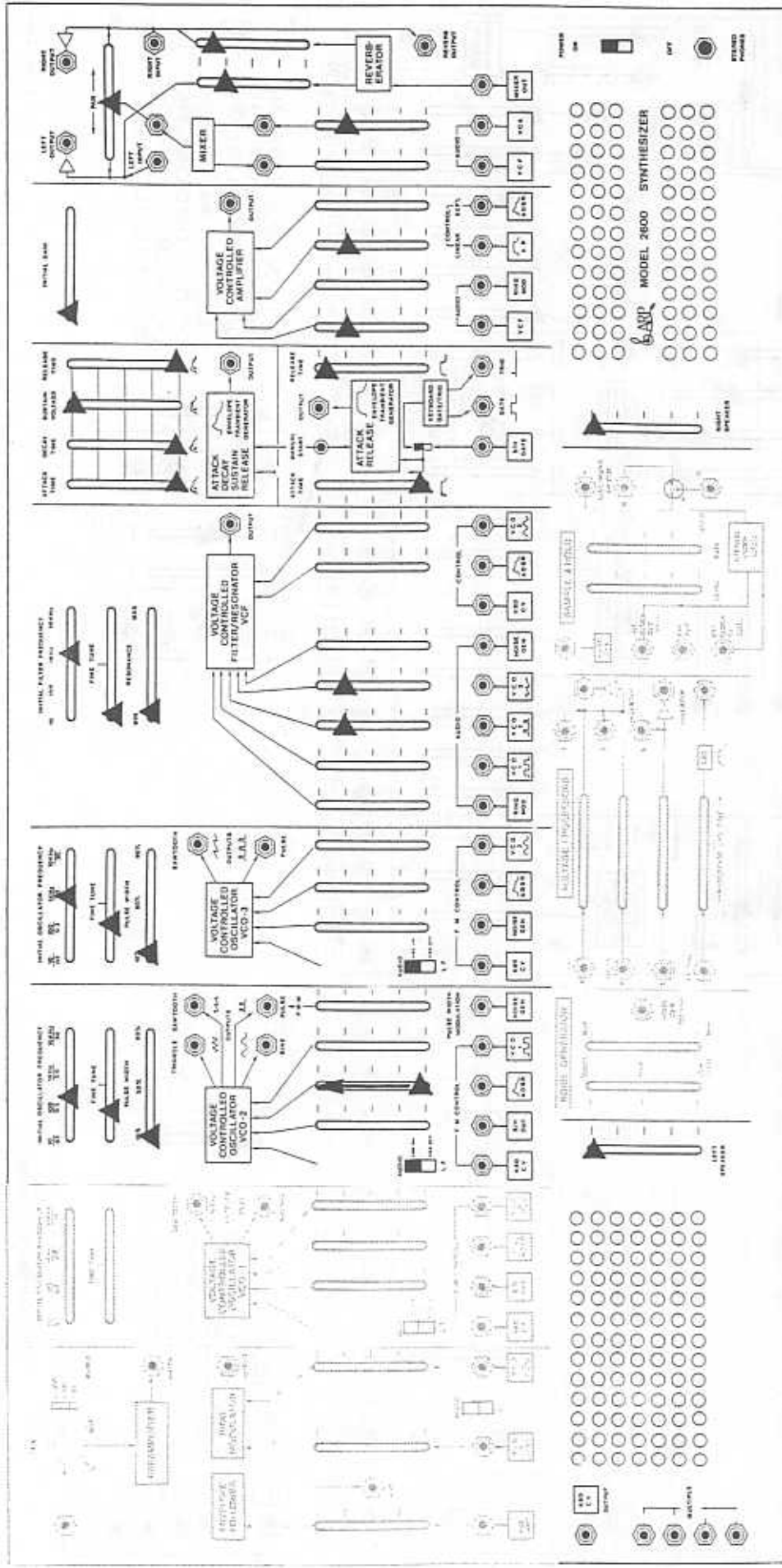

1. Tune VCO 2 and 3 to desired interval.
2. Raise ADSR into VCO 2.
3. Play staccato.

Release-follow

89.



SYDELTECH

33

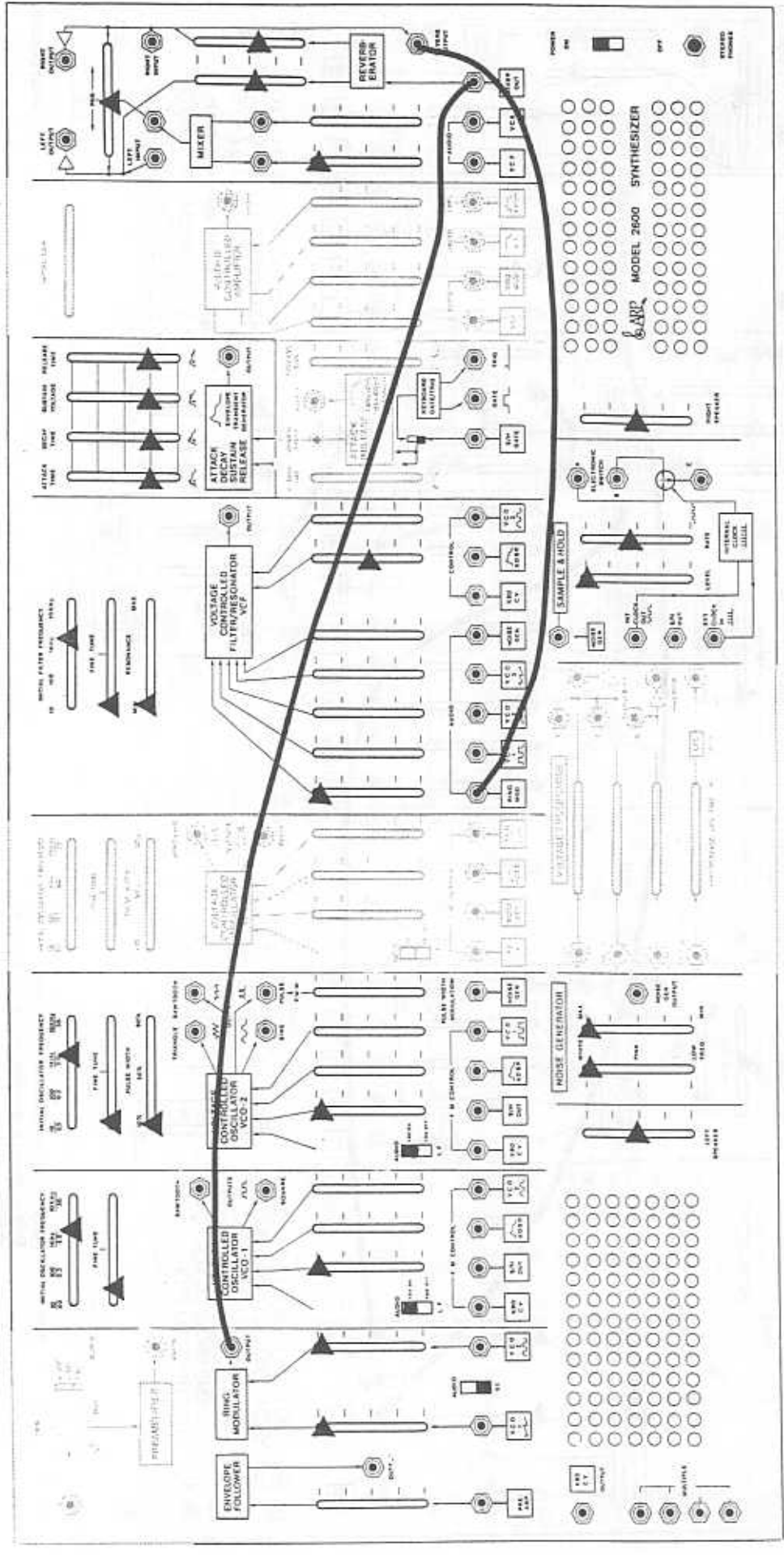

2 PATCHCORDS

S/H Echo

91.

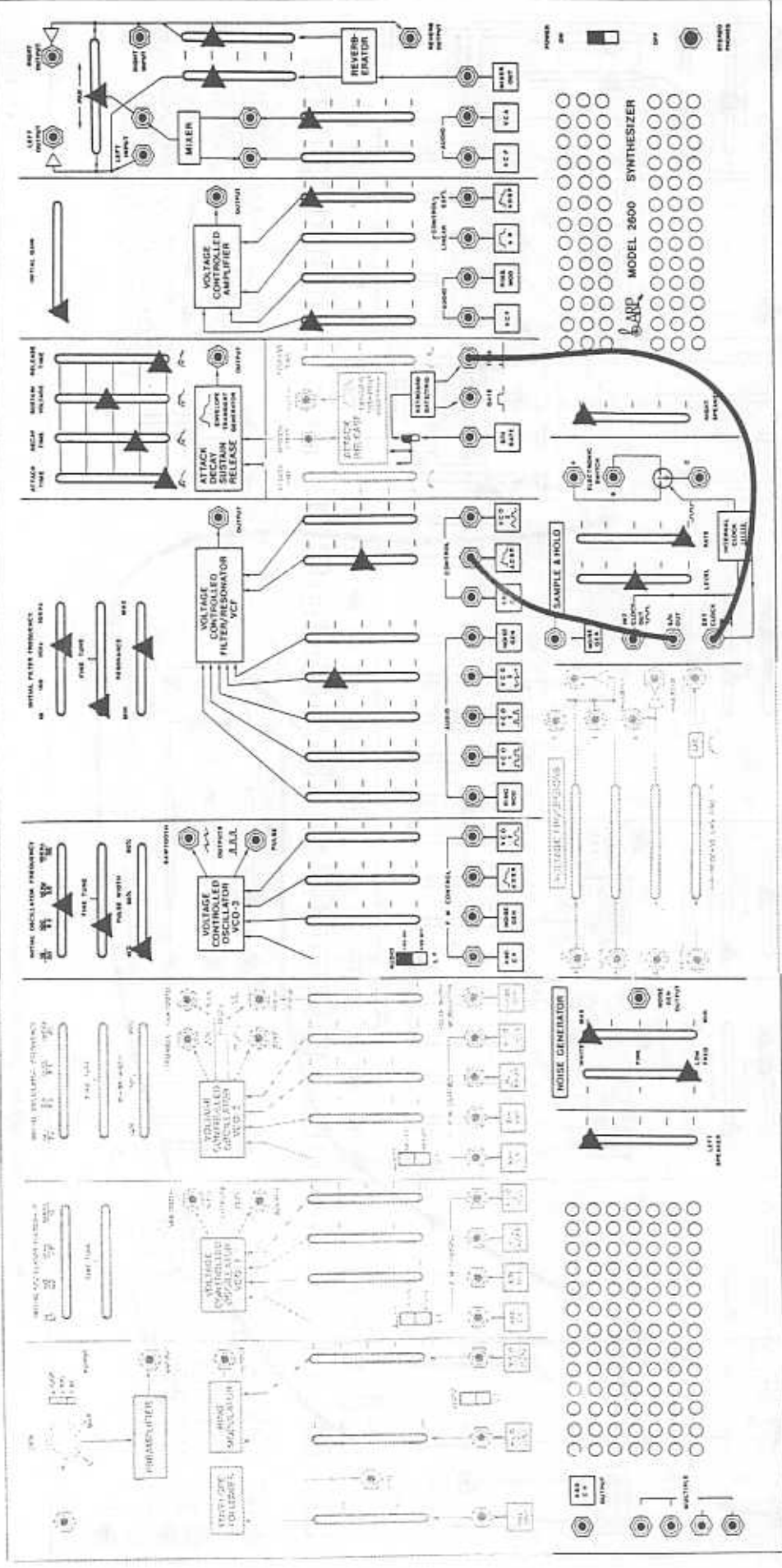

2 PATCHCORDS

# Random Filter Sampled Keyboard Triggered





Signal Source

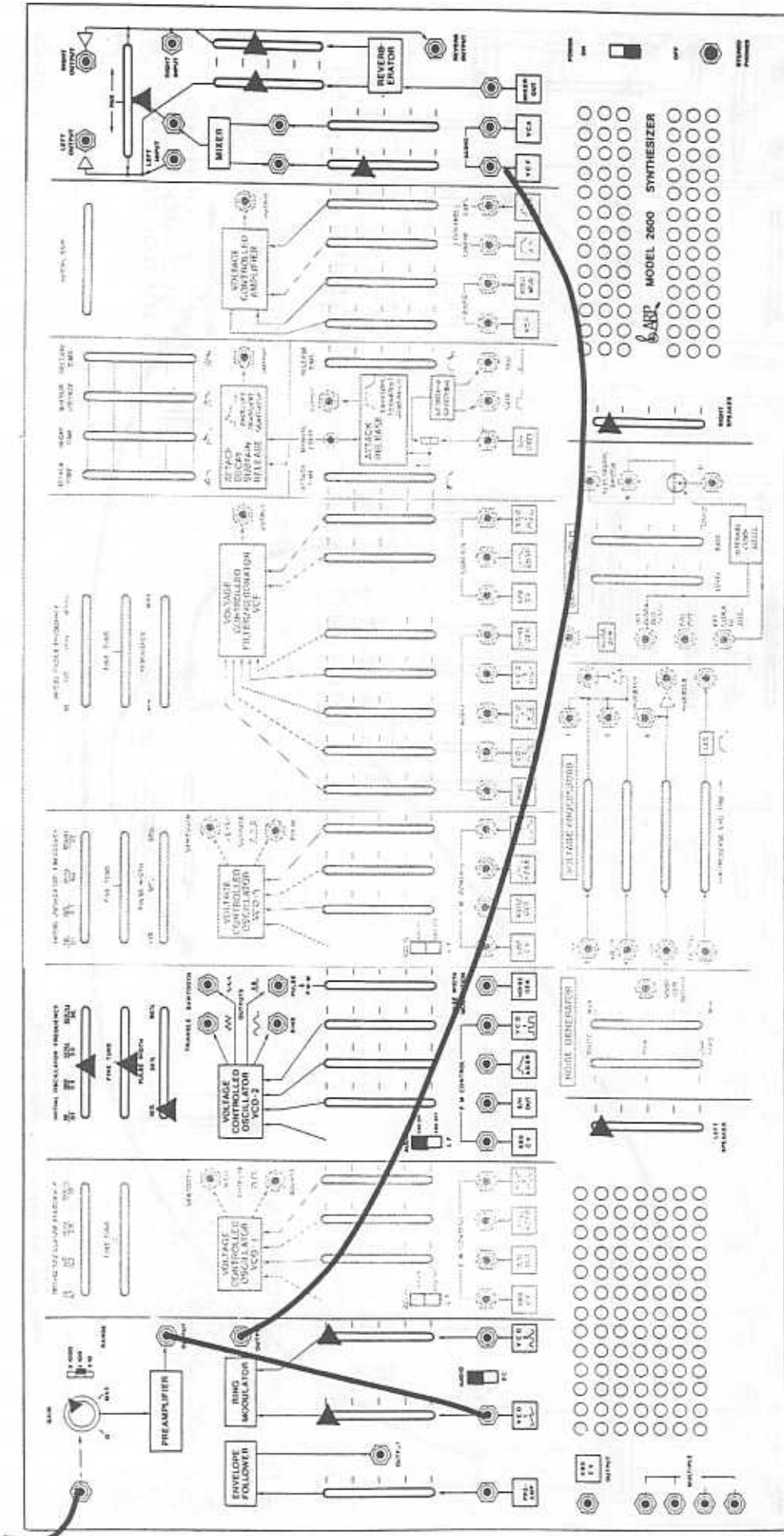

2 PATCHCORDS

Modulated External Source

97.

Signal Source

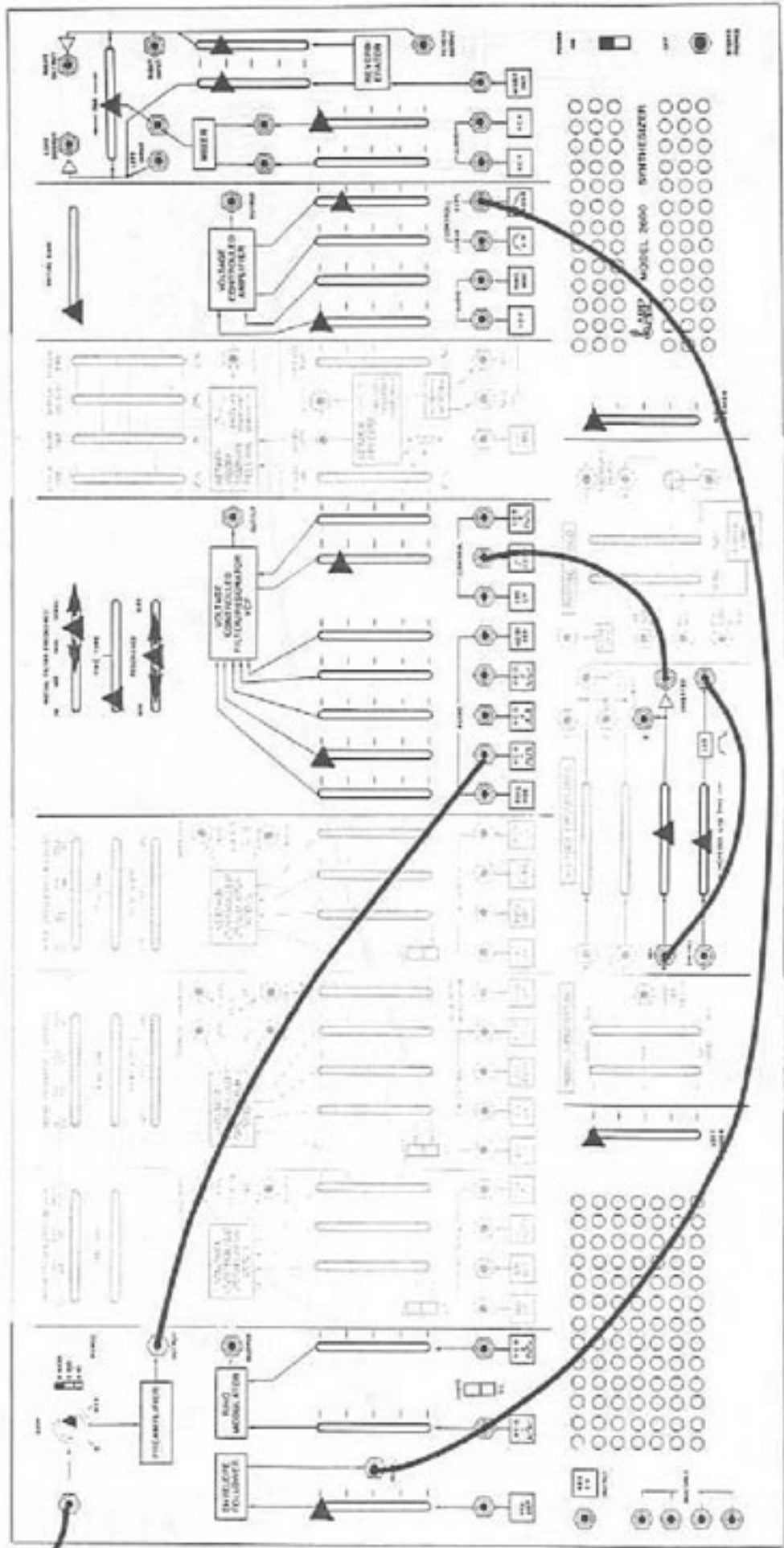

Adjust VCF frequency and Resonance as desired.

4 PATCHCORDS

**PROSCHOOL-SOUND**  
www.oldschool-sound.com

!!!!!! An exclusive free release !!!!!

SCAN by PASCAL W -aka- "Analog Monkey"  
Free manuals for Free Vintage addicts ! Creative use only  
\$\$\$ Not For Resale \$\$\$  
( Le bizness de ressources est un sport de pitrizes )

'Ow' on External Source

98.

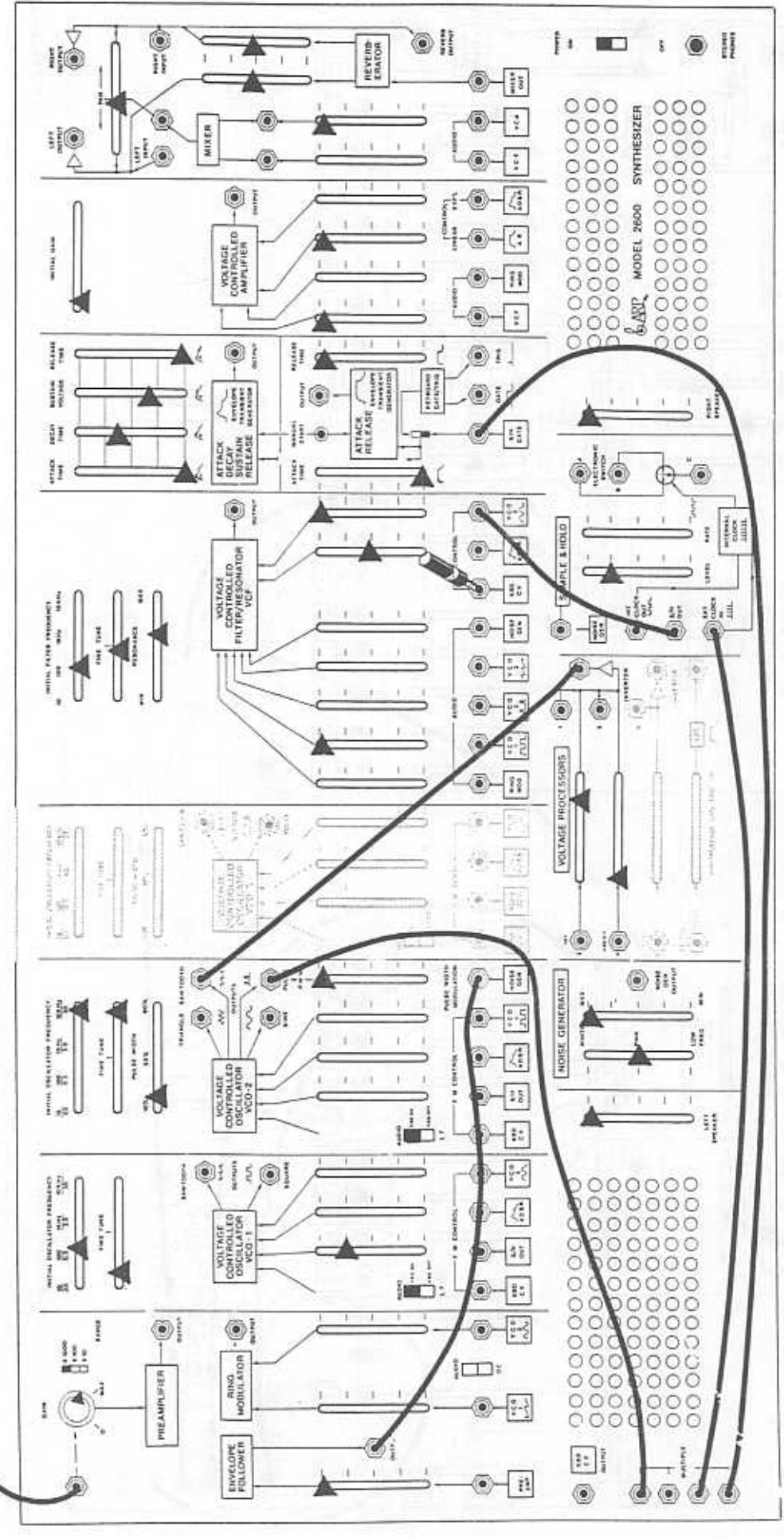
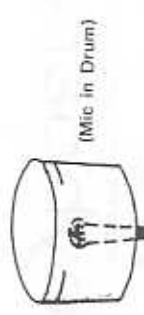

Adjust Preamp Gain for Gate sensitivity.

6 PATCHCORDS

# Drum-controlled ADSR and S/H 99.

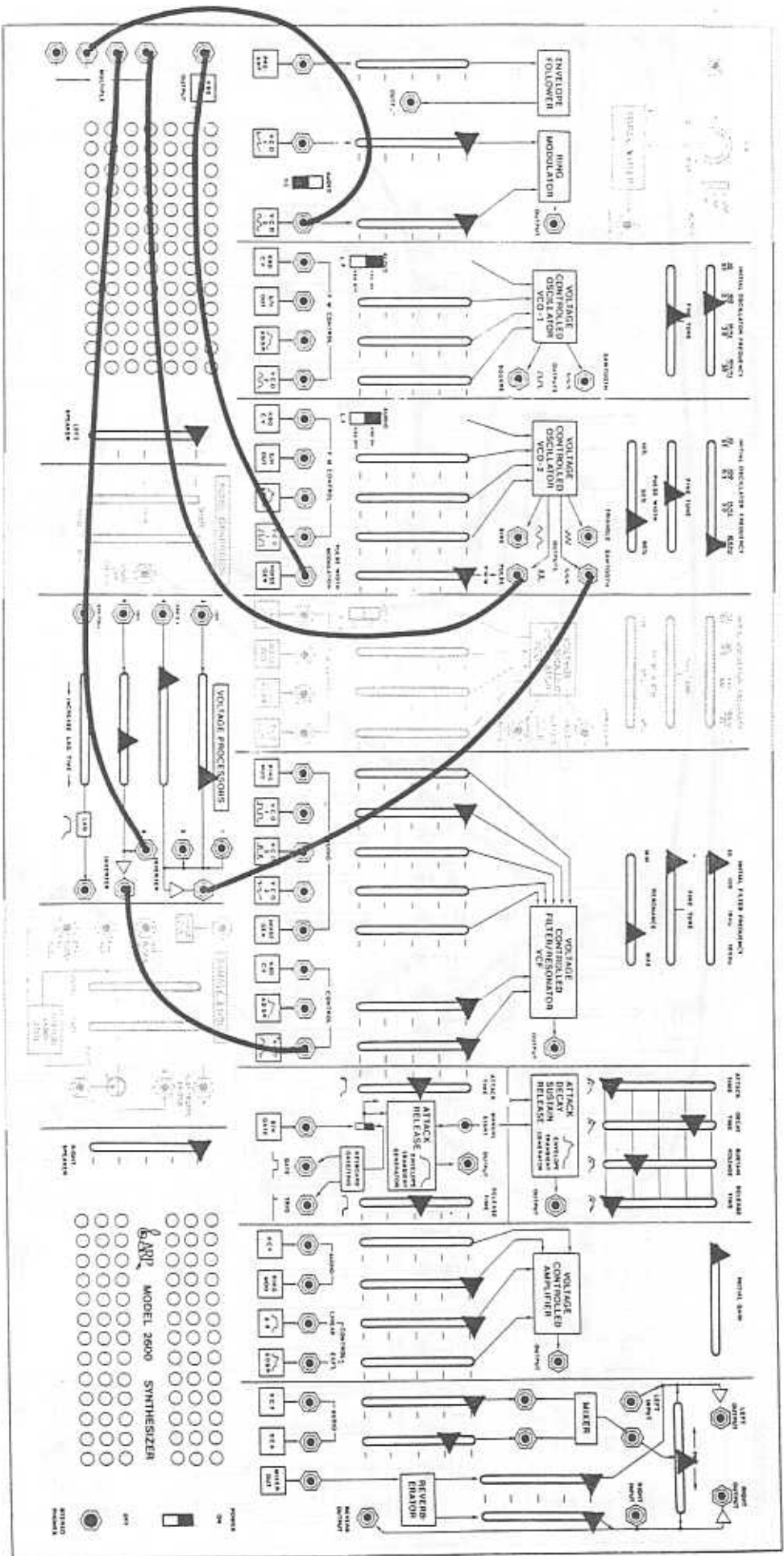
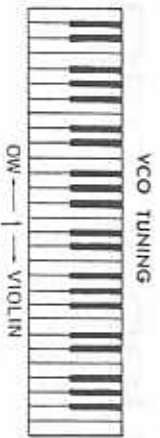

Split Keyboard Adjustments:

1. Adjust VCO 2 Pulse Width while playing Keys C3 and Csharp3 alternately. You are fine tuning the placement of the split so that a violin will be heard on Csharp 3 and an 'Ow' will be heard on C3.
2. Adjust the +10V inverter slider for desired filtering on 'Ow'.

6 PATCHCORDS

# Split Keyboard: Bass "Ow" and Violin

# 100.

Signal Source

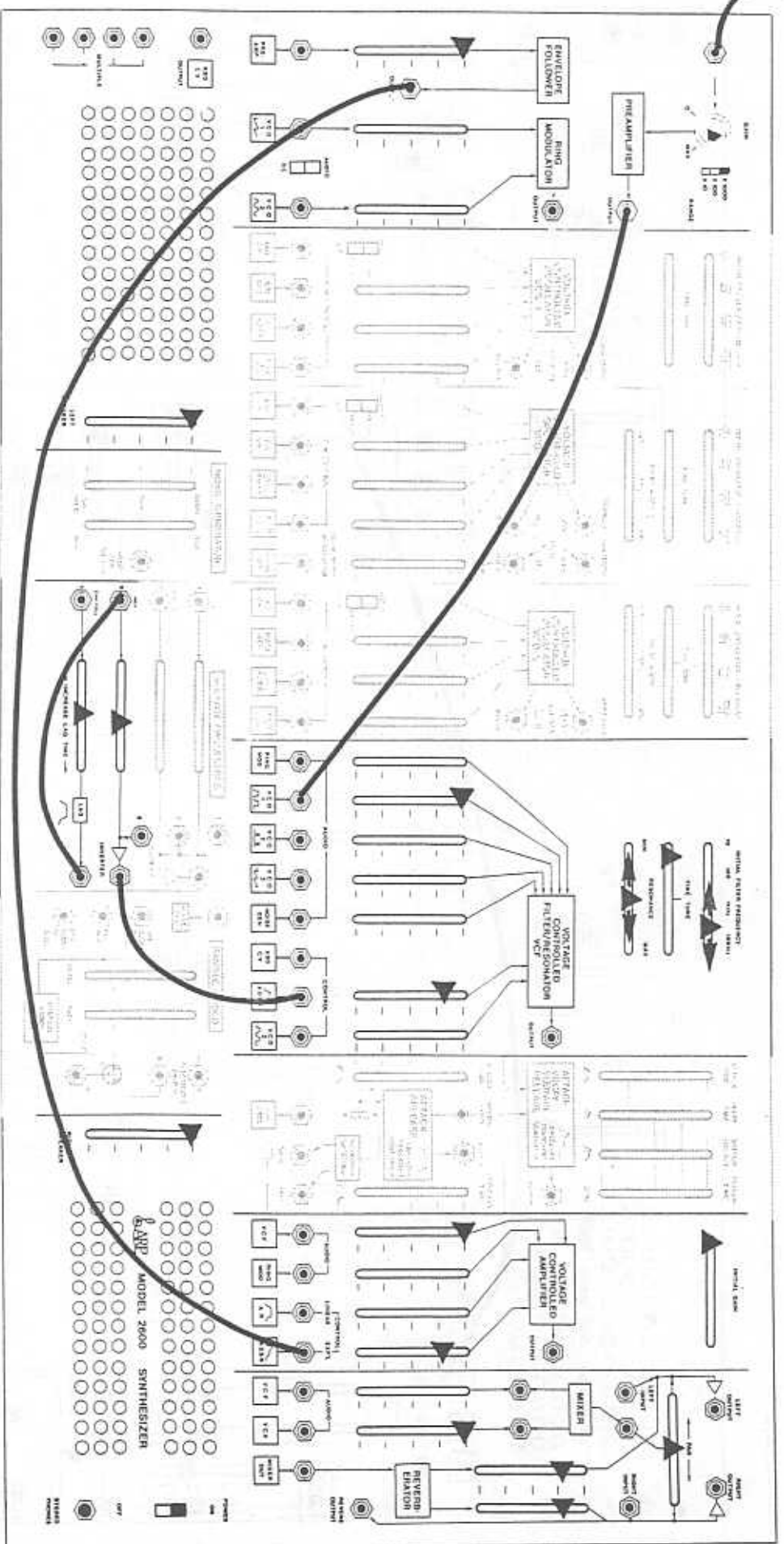

Adjust VCF frequency and Resonance as desired.

A PATCHCORDS

“OW” on External Source

98.



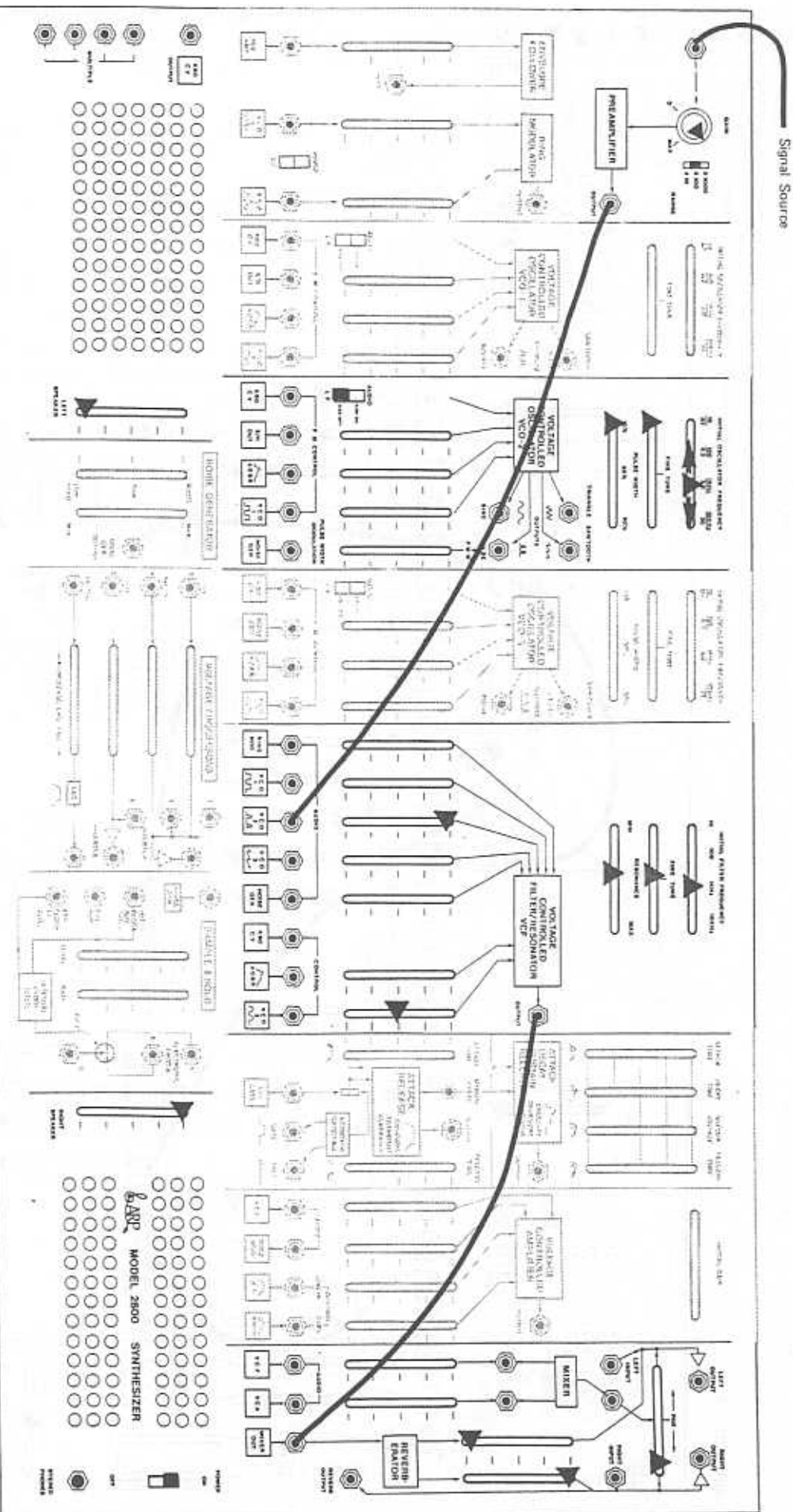

Adjust: VCO 2 into VCF for phase.  
VCO 2 frequency for phase-shifting speed.

2 PATCHCORDS

# Ethereal Phase-shifting on External Source

# 96.



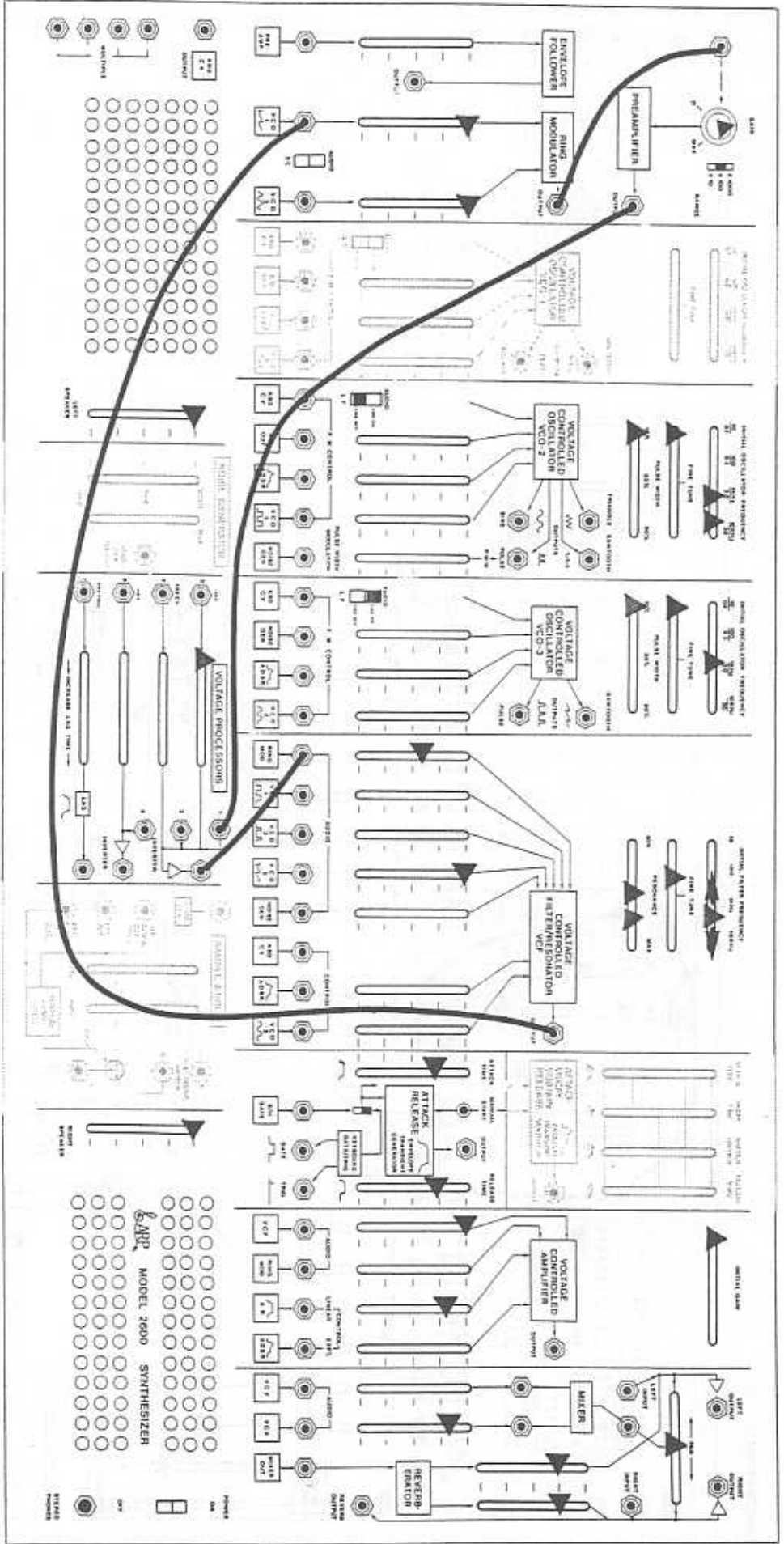

Note: This patch will give you a basic pitch and a harmonic which fades in and out. Different harmonics may be selected by altering the VCF frequency.

4 PATCHCORDS

# Voltage-controlled Resonance



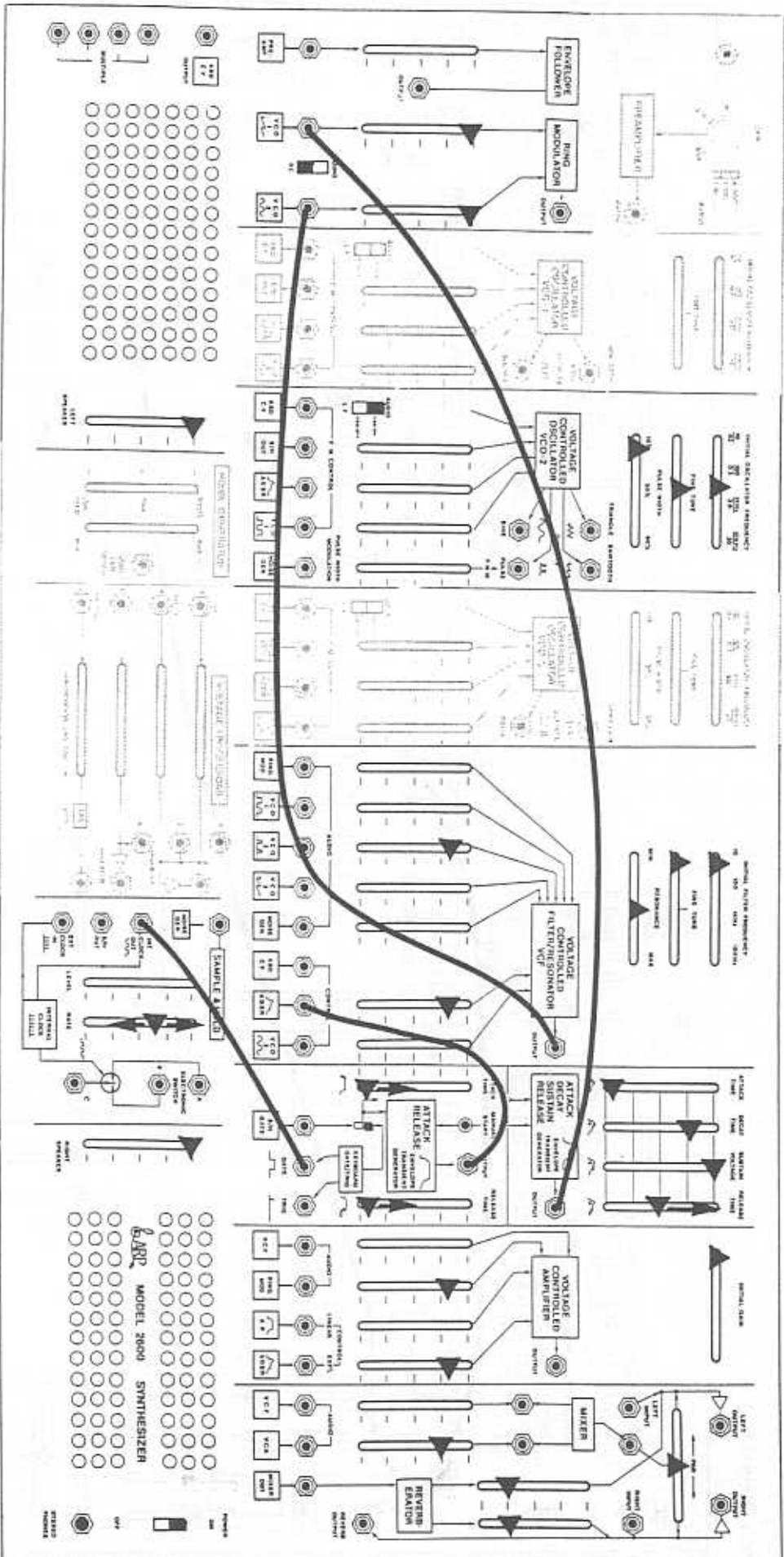

Note:  
 ADSR release determines number of repeats.  
 Echo is used on single notes only—AR is repeating  
 envelope on fade-out.  
 AR can be altered for repeated "wow" effect.  
 Adjust S/H Rate for repeat rate.

4 PATCHBOARDS



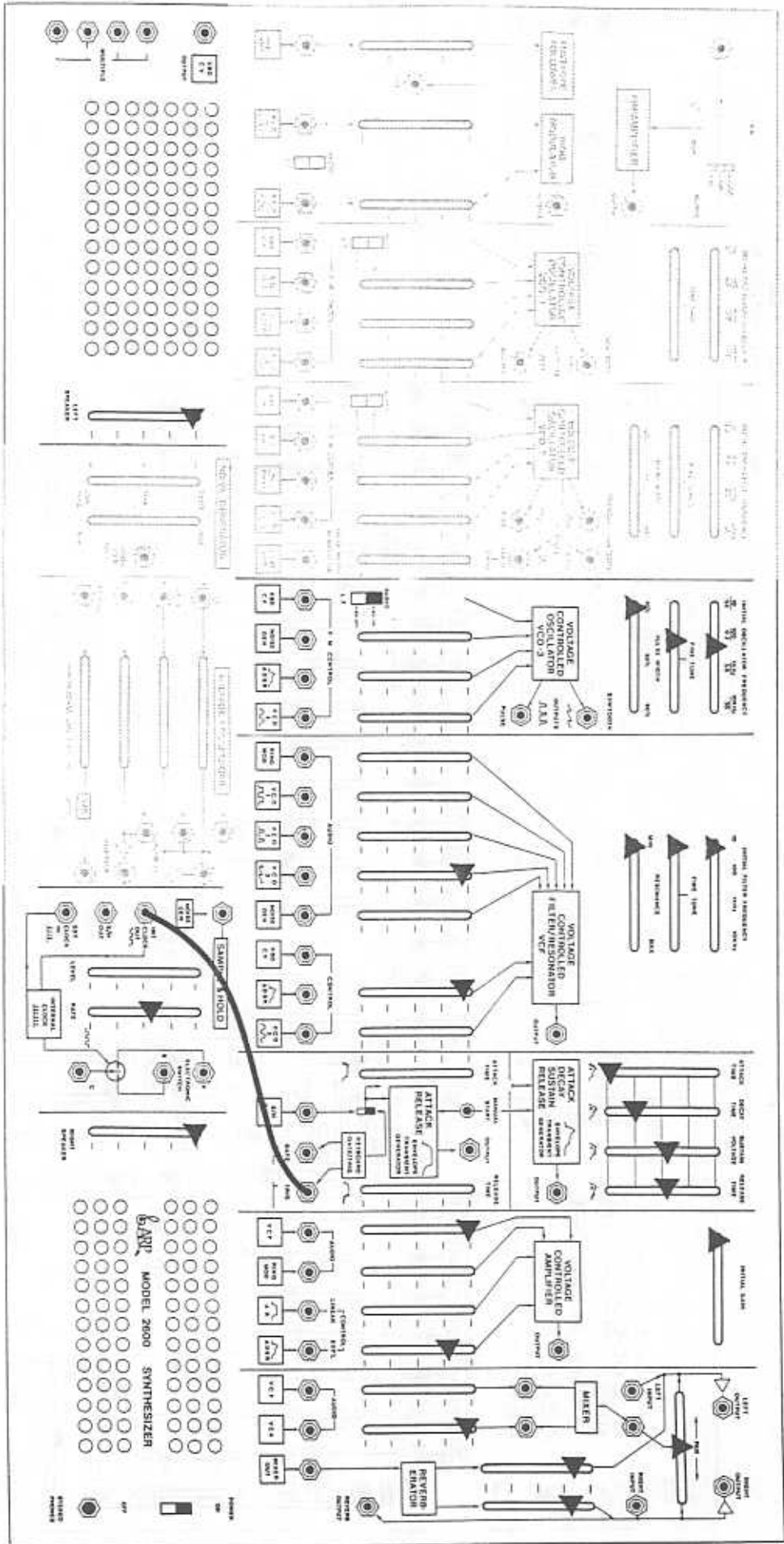

Adjust S/H Rate for repeat speed.

1 PATCHCORD

Touch-repeat

90.



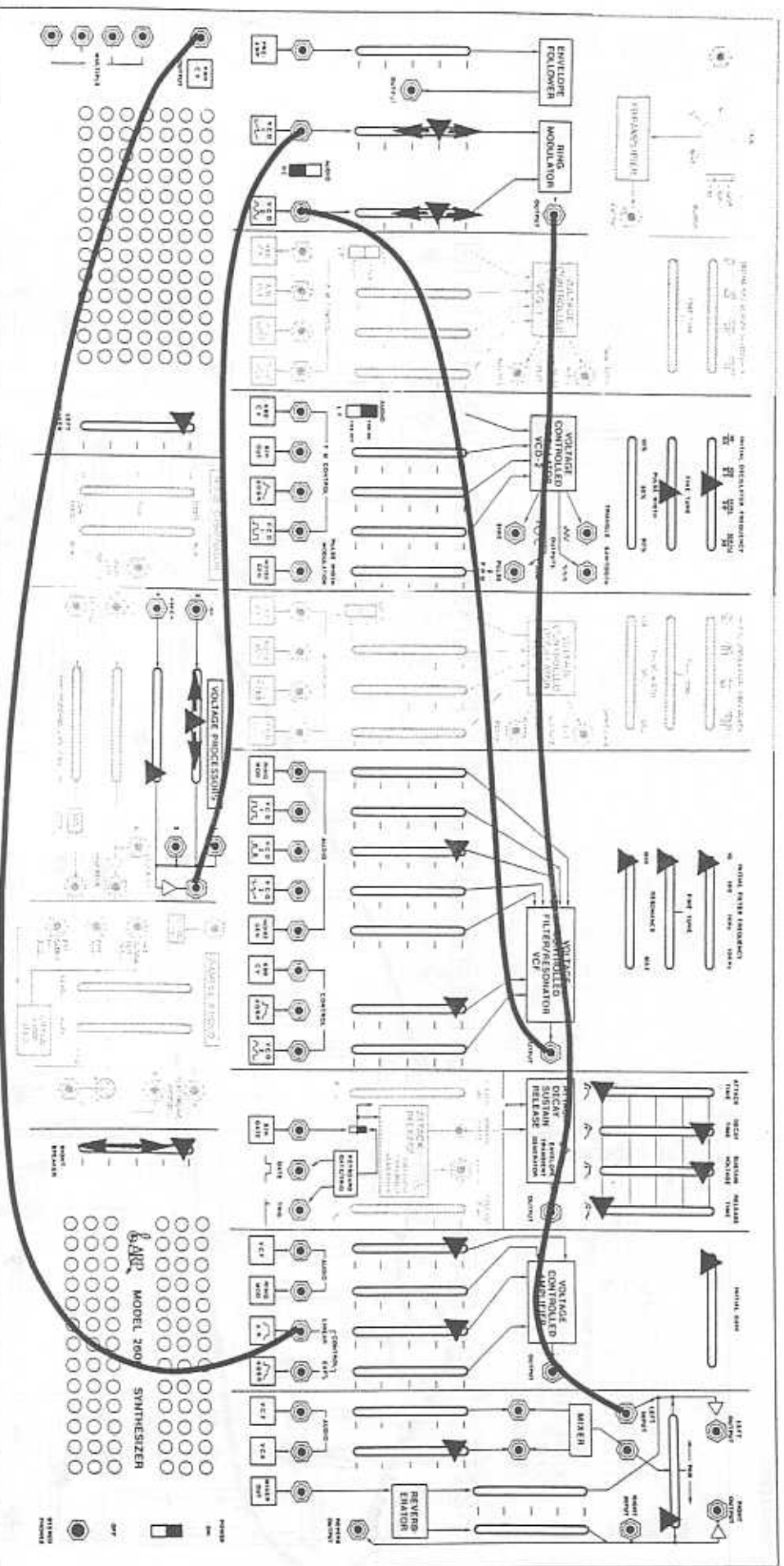

1. Close right speaker
2. Press Key C5 and adjust Inverter slider to get minimum volume in left speaker.
3. Open right speaker.
4. Adjust input sliders on Ring Modulator for balance while depressing Key C3.

# Keyboard-controlled Pan

4 PATCHCORDS

**88.**

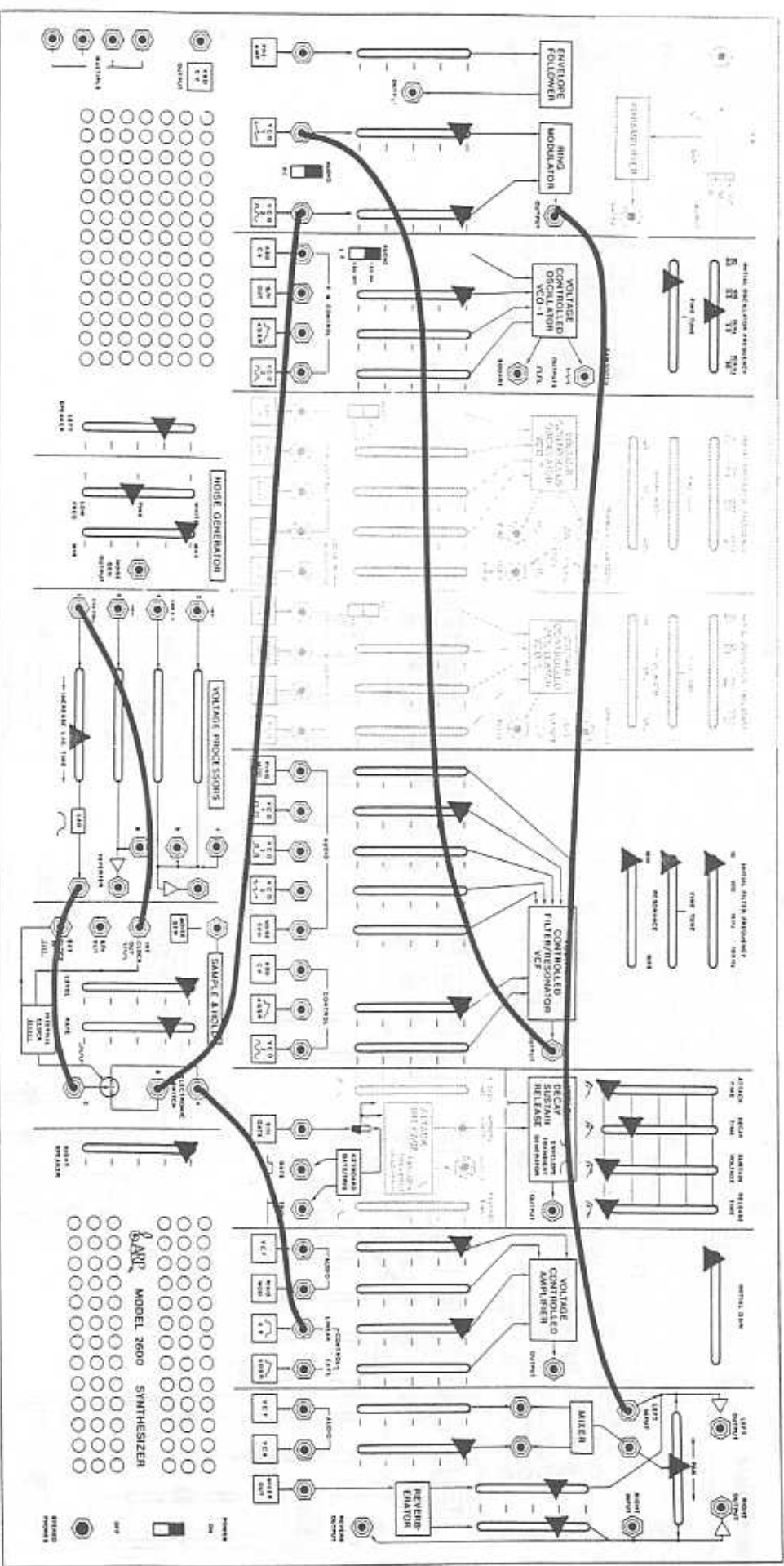

6 PATCHCORDS

Auto-pan on S/H

86.

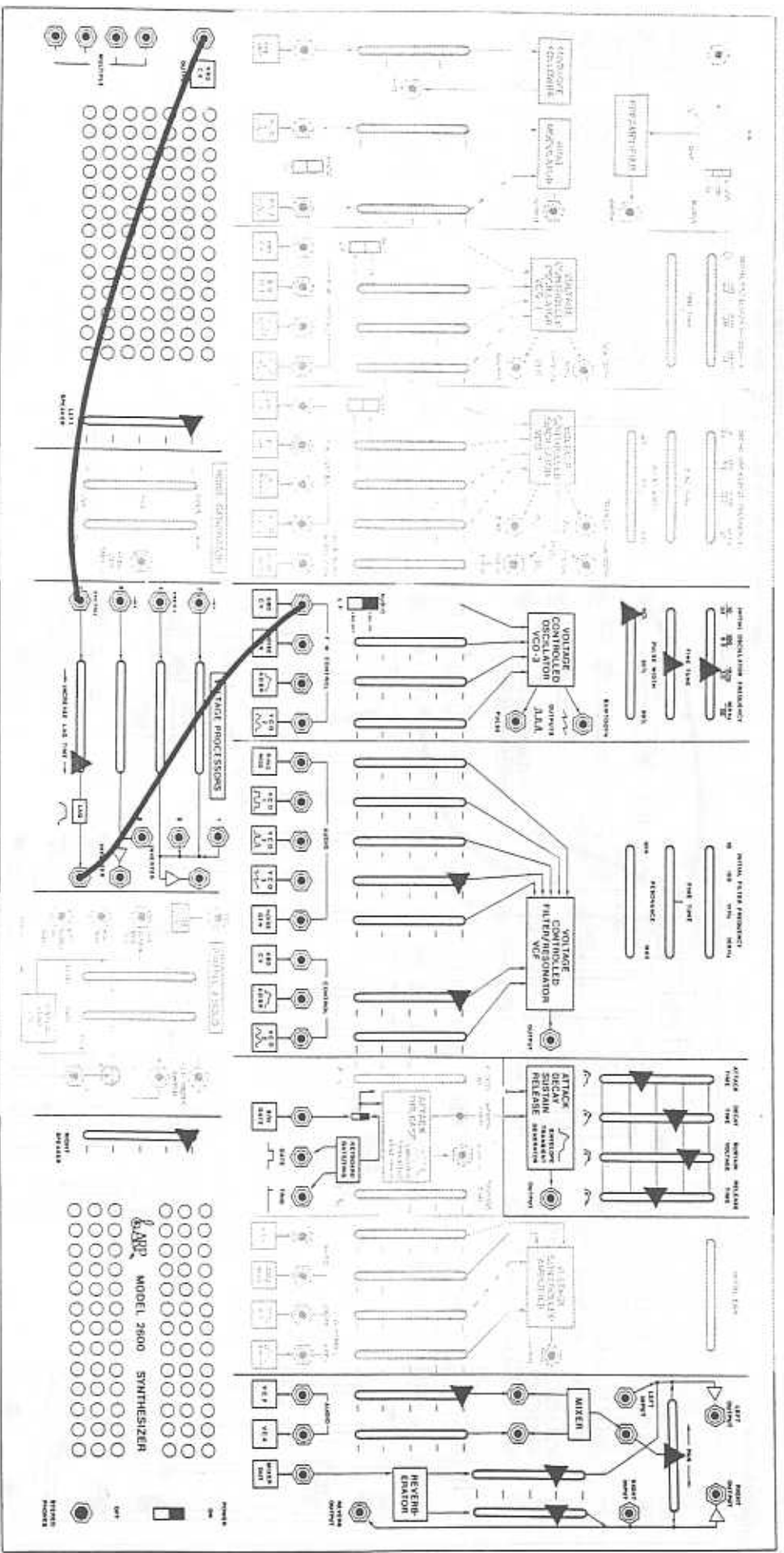

Lagged Keyboard Voltage

84.



Patented, S14001195A1

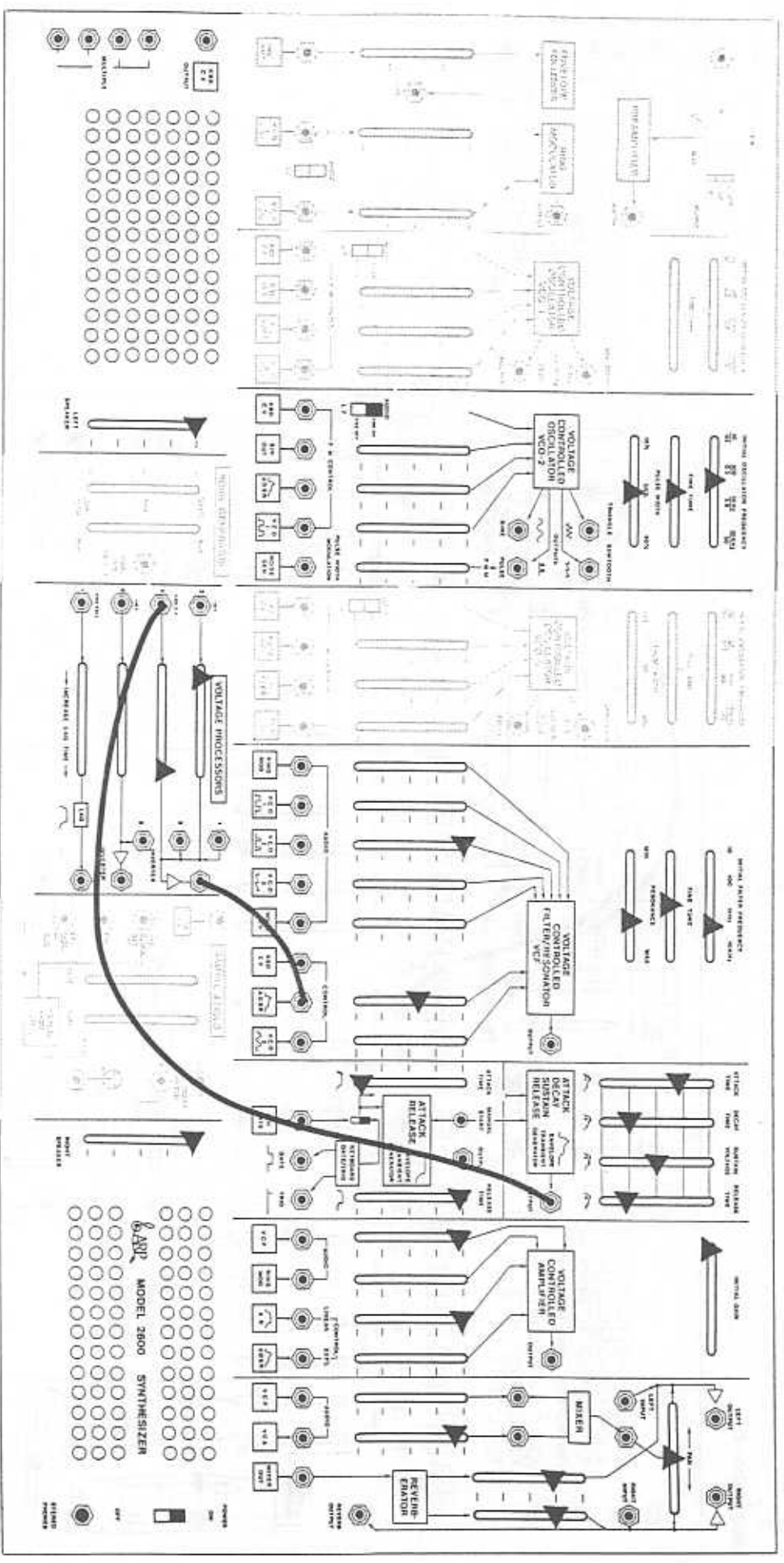

Adjust VCF frequency for desired 'owwa';

2 PATCHCORDS

"Owwa" or Inverted ADSR to VCF

82.



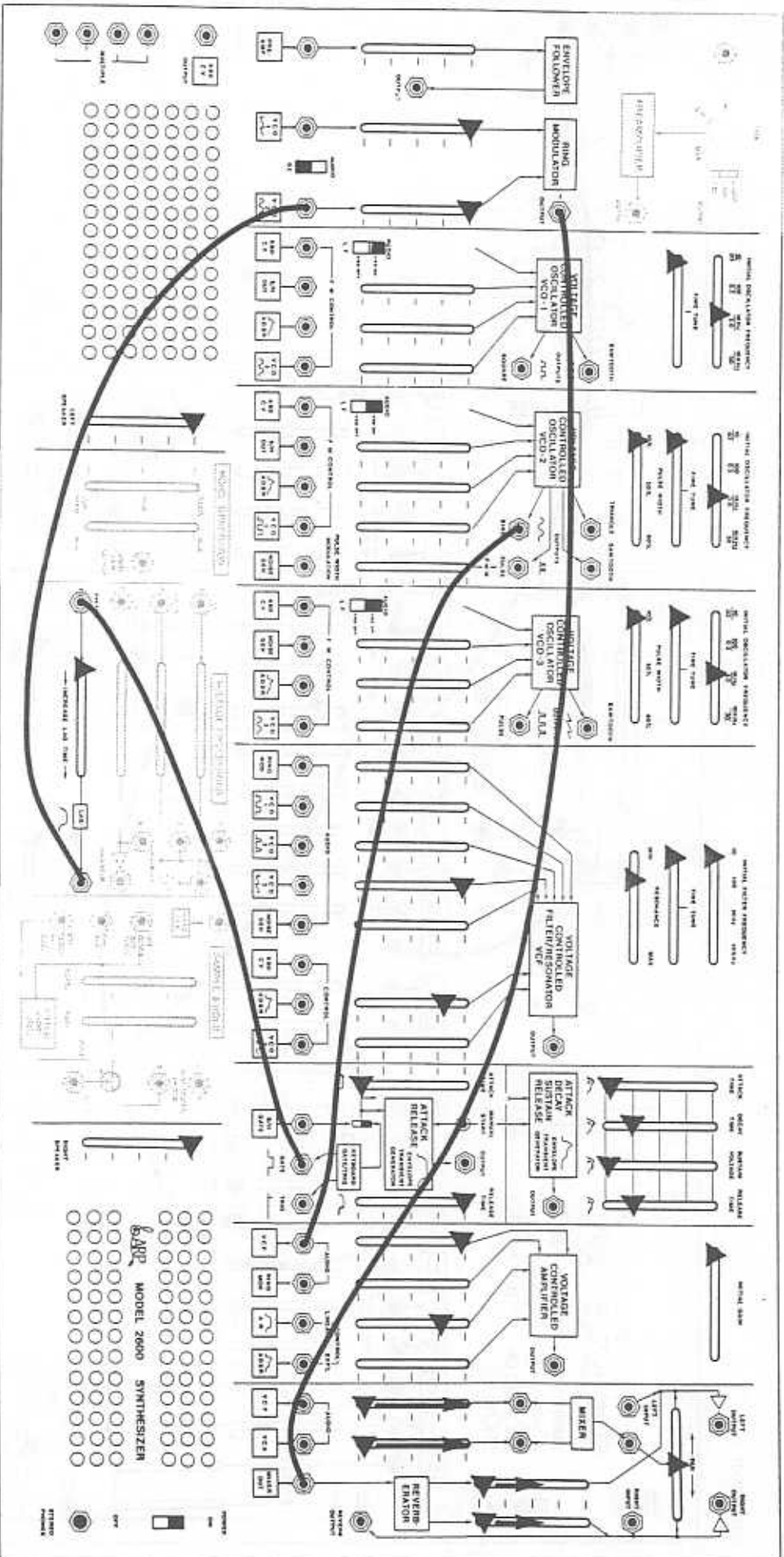

Tune Oscillators as desired.

Balance volume at arrows.

4 PATCHCORDS

# Trio: Three Separate Envelopes & Timbres 80.



THE UNIVERSITY OF MICHIGAN LIBRARY



Downloaded from <http://www.industrydocuments.ucsf.edu/docs/3x3x>

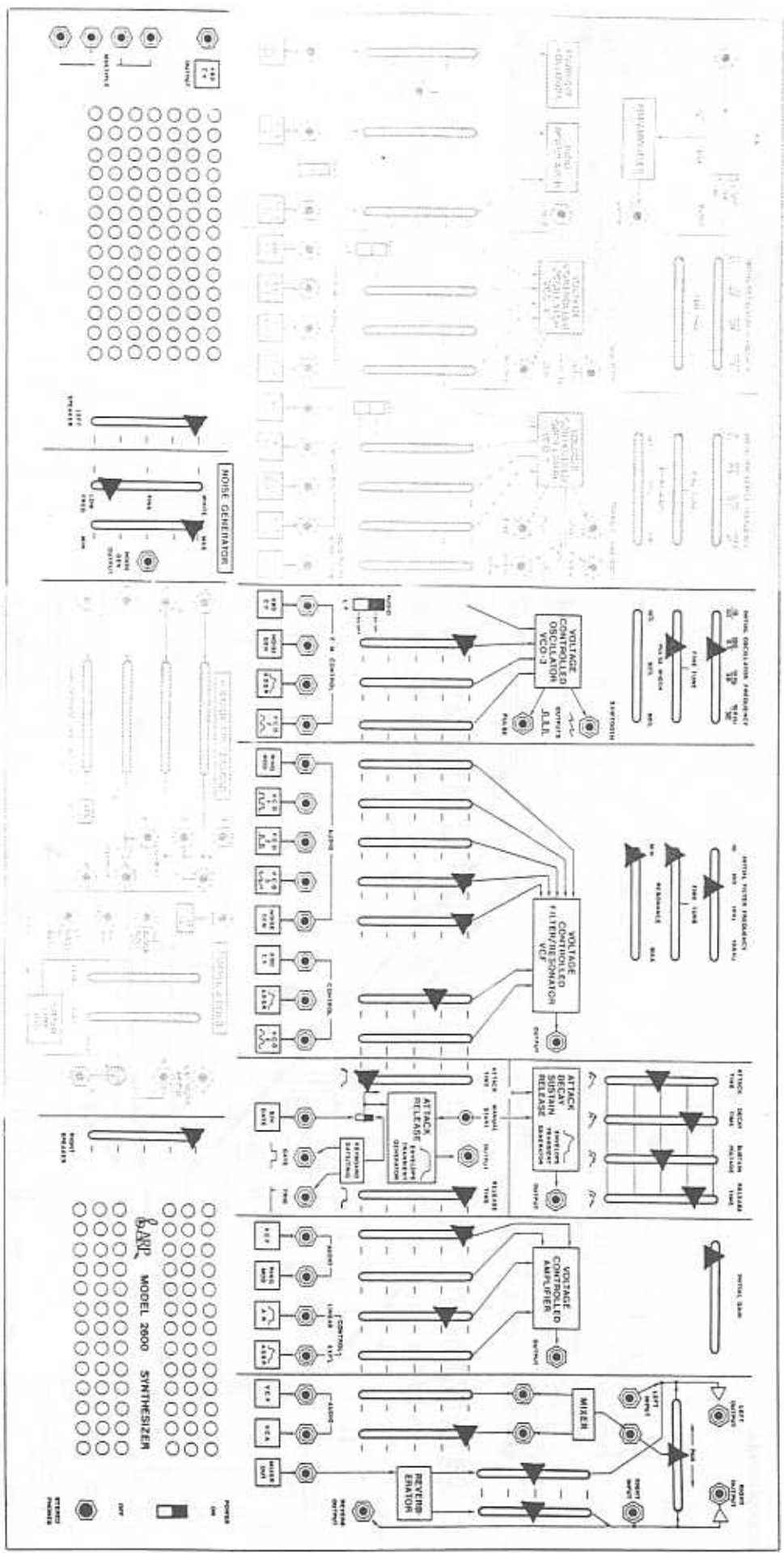

Explosion

78.



Designed by Dave & Bob

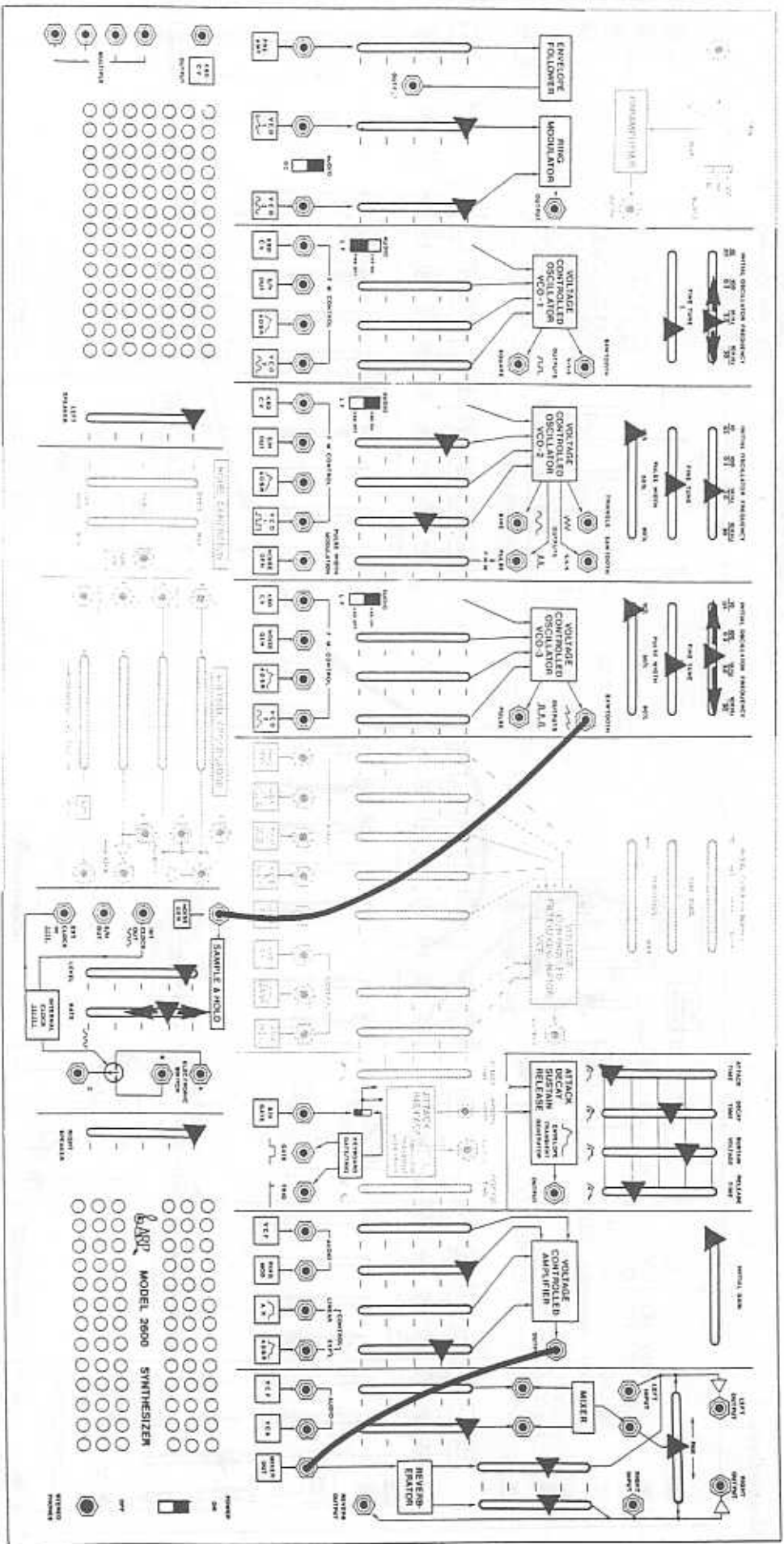

Adjust:  
 VCO 1 frequency for speed of pattern,  
 VCO 3 frequency for different patterns,  
 S/H Rate for speed of drops.

2 PATCHCORDS

# Prancing Raindrops

# 76.



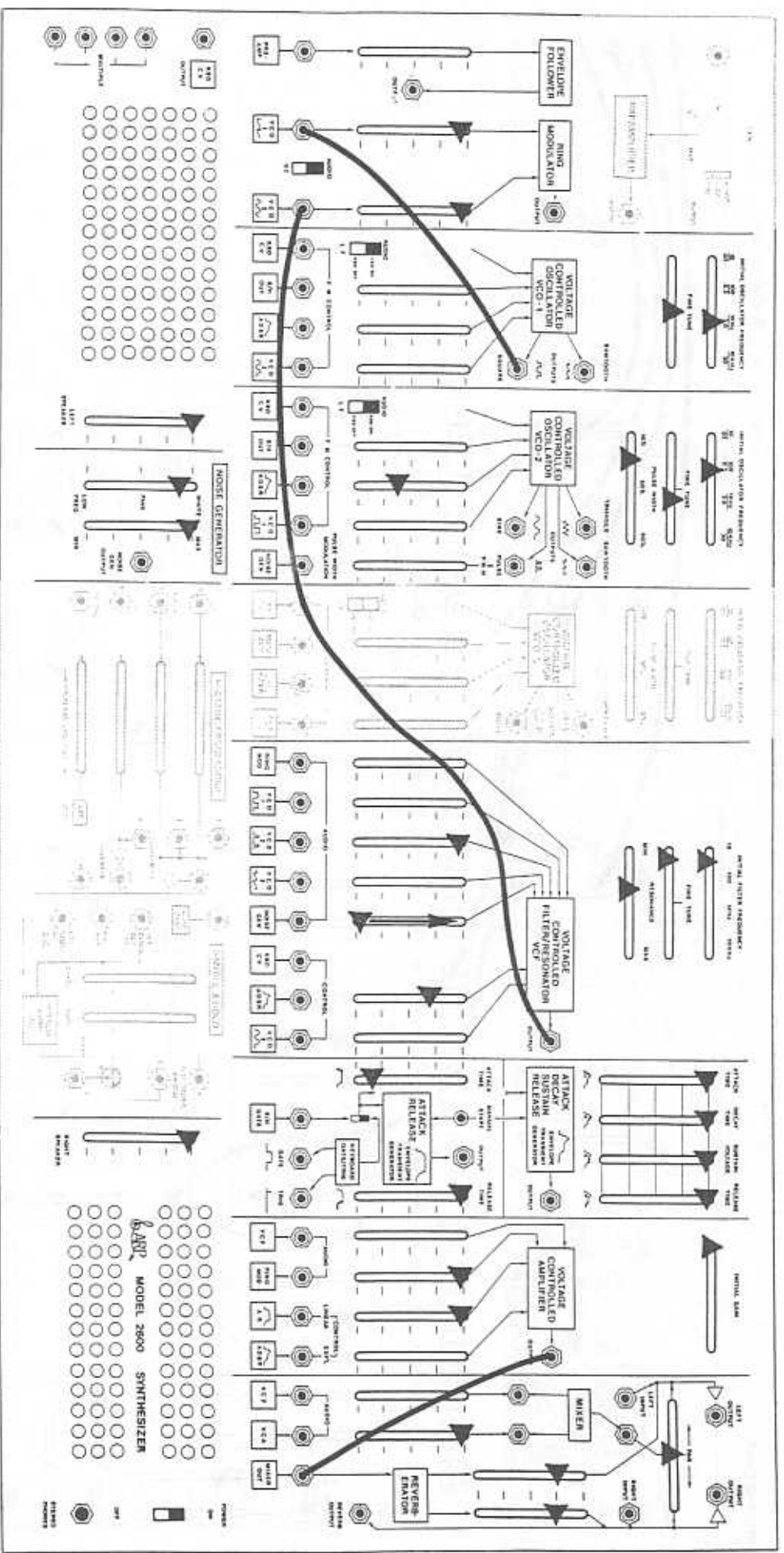

Raise Noise into VCF for special effects.  
PLAY KEY Effect3

3 PATCHCORDS

# Wampus Monster

# 74.



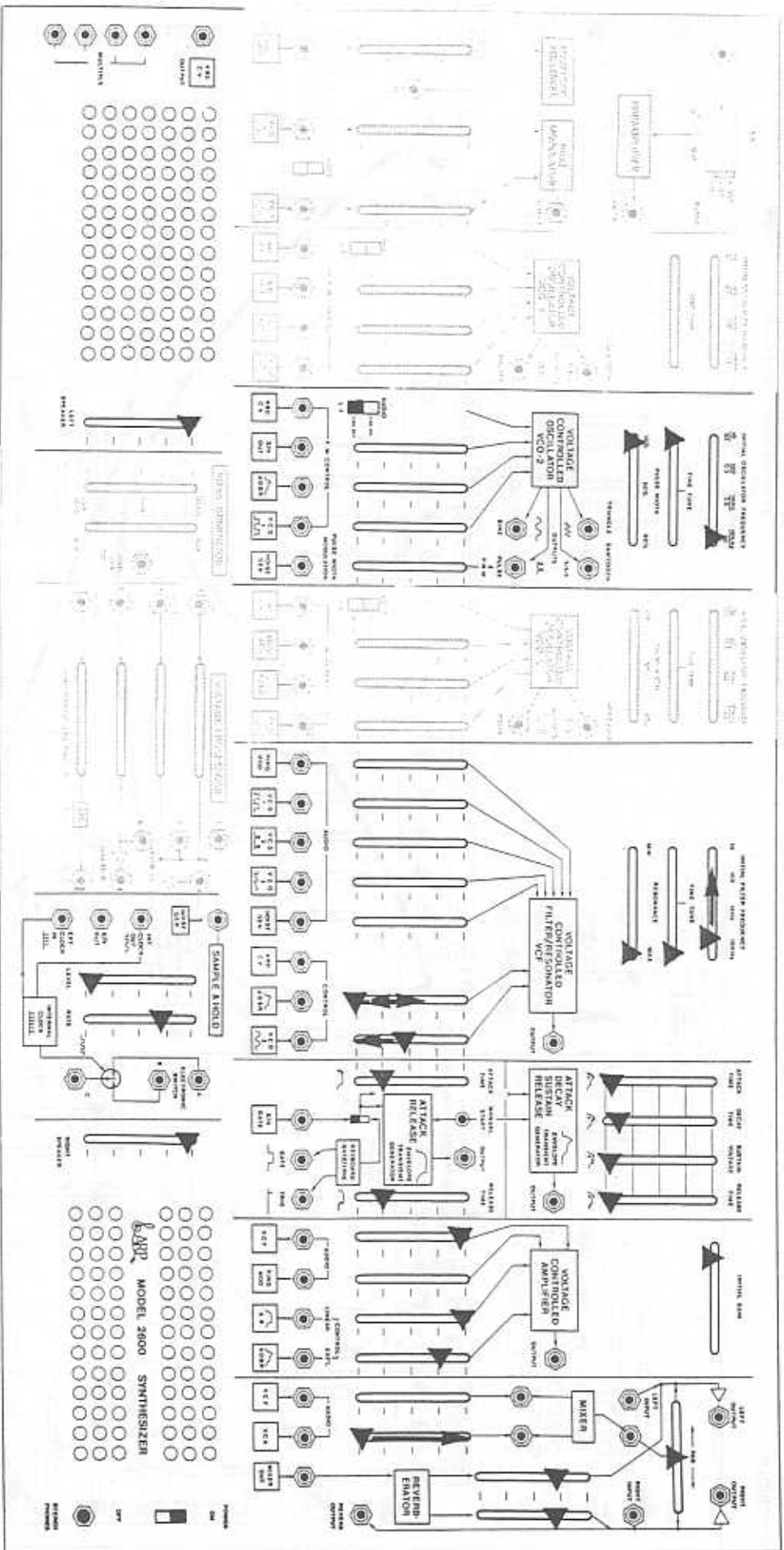

SEQUENCE:

1. Raise VCA into Mixer.
2. Move VCF frequency from 10K to 100 slowly.
3. Lower VCO 2 ~ | at VCF and jerk ADSR slider into VCF up and down in time to the drum solo.

Edgar Winter's "Frankenstein"

72.

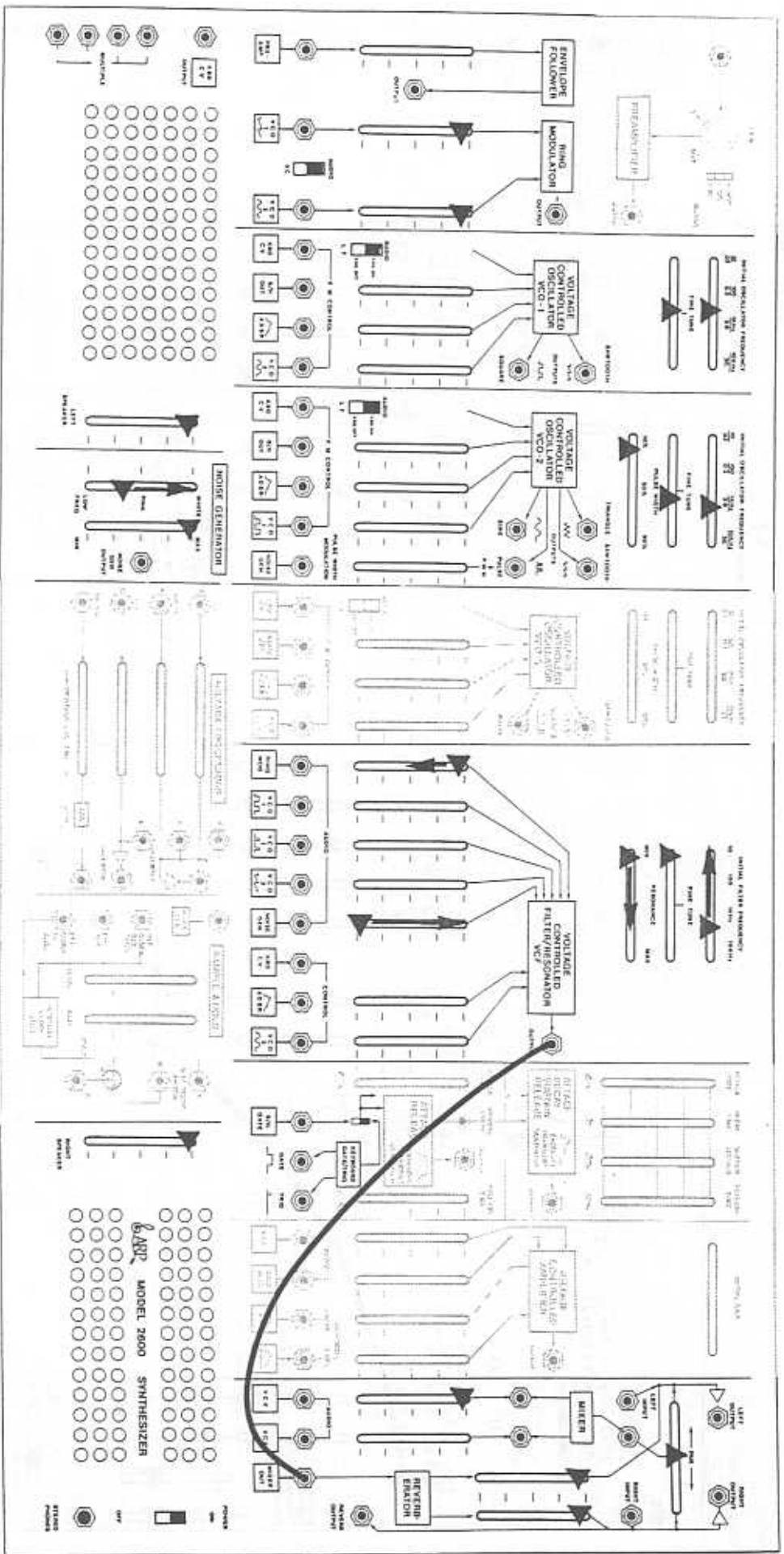

Portamento

Procedure:

1. Play Key C1, glide to C5.
2. Raise Noise into VCF.
3. Lower Ring Mod at VCF as shown.
4. Raise Noise color---Pink to White.
5. Simultaneously, move VCF frequency to left and move Resonance to right.

1 PATCHCORD

# 727 Starting Up, Taxing & Taking Off 70.



THE UNIVERSITY OF CHICAGO

FORBIDDEN TO REPRODUCE WITHOUT PERMISSION OF THE PUBLISHER

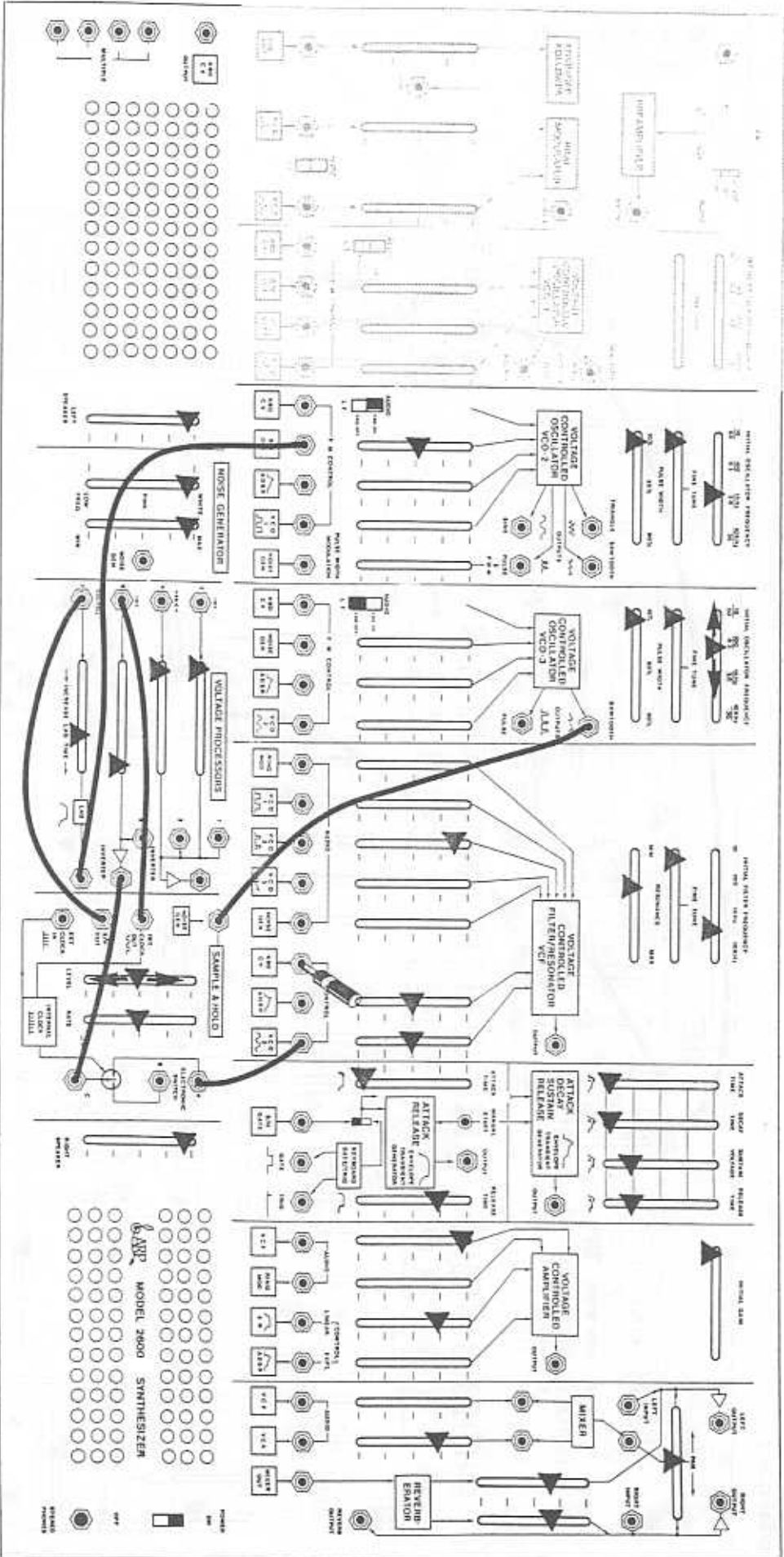

Tune: VCO 3 for desired pattern.  
S/H level for desired interval.

6 PATCHCORDS  
1 DUMMY PLUG

Gliding Intervals

68.



Three-Job's Control Two VCO's

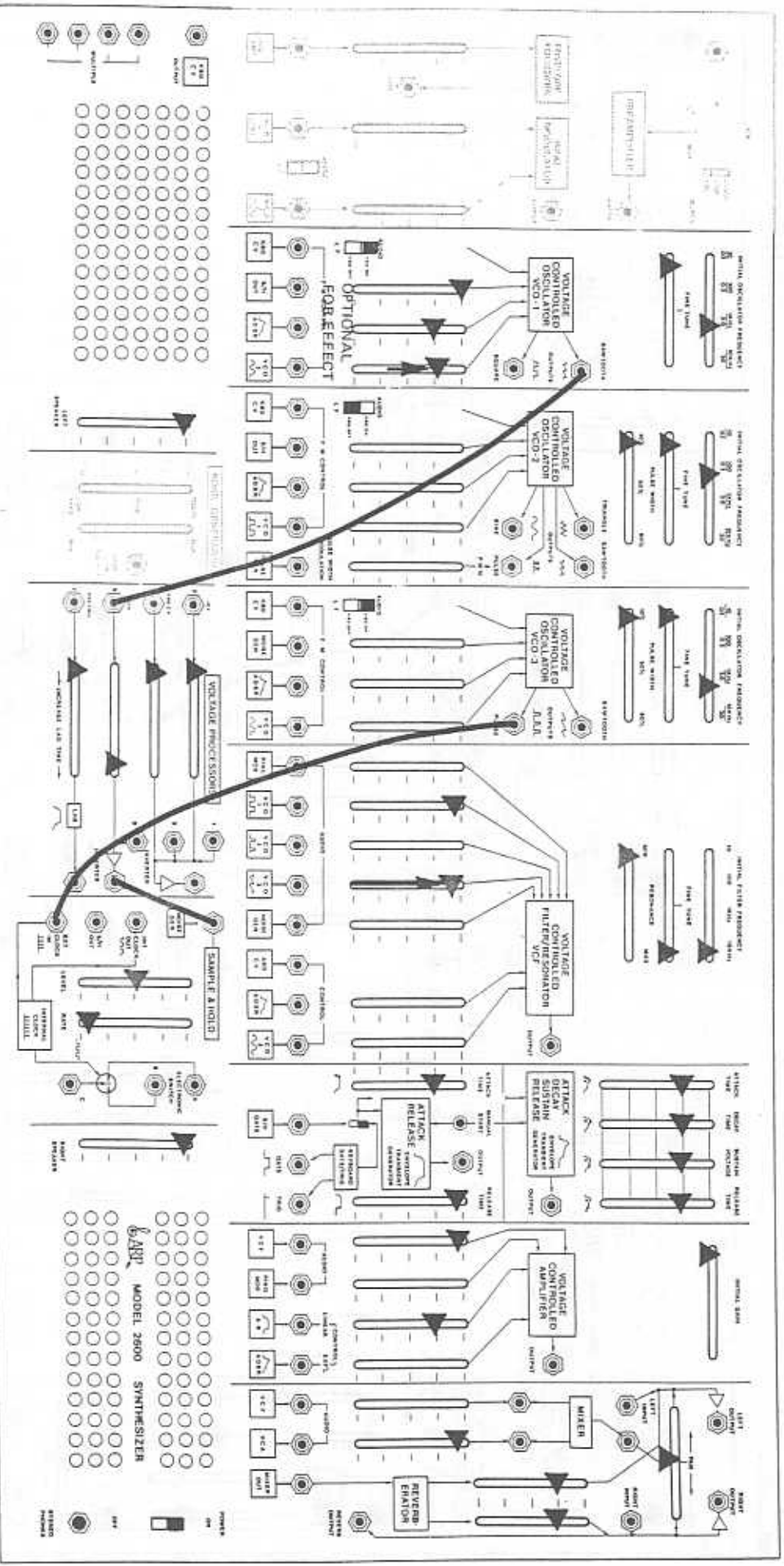

Be certain that the frequency of VCO 3 is above that of VCO 1

3 PATCHCORDS

# Inharmonic Sequencing

66.





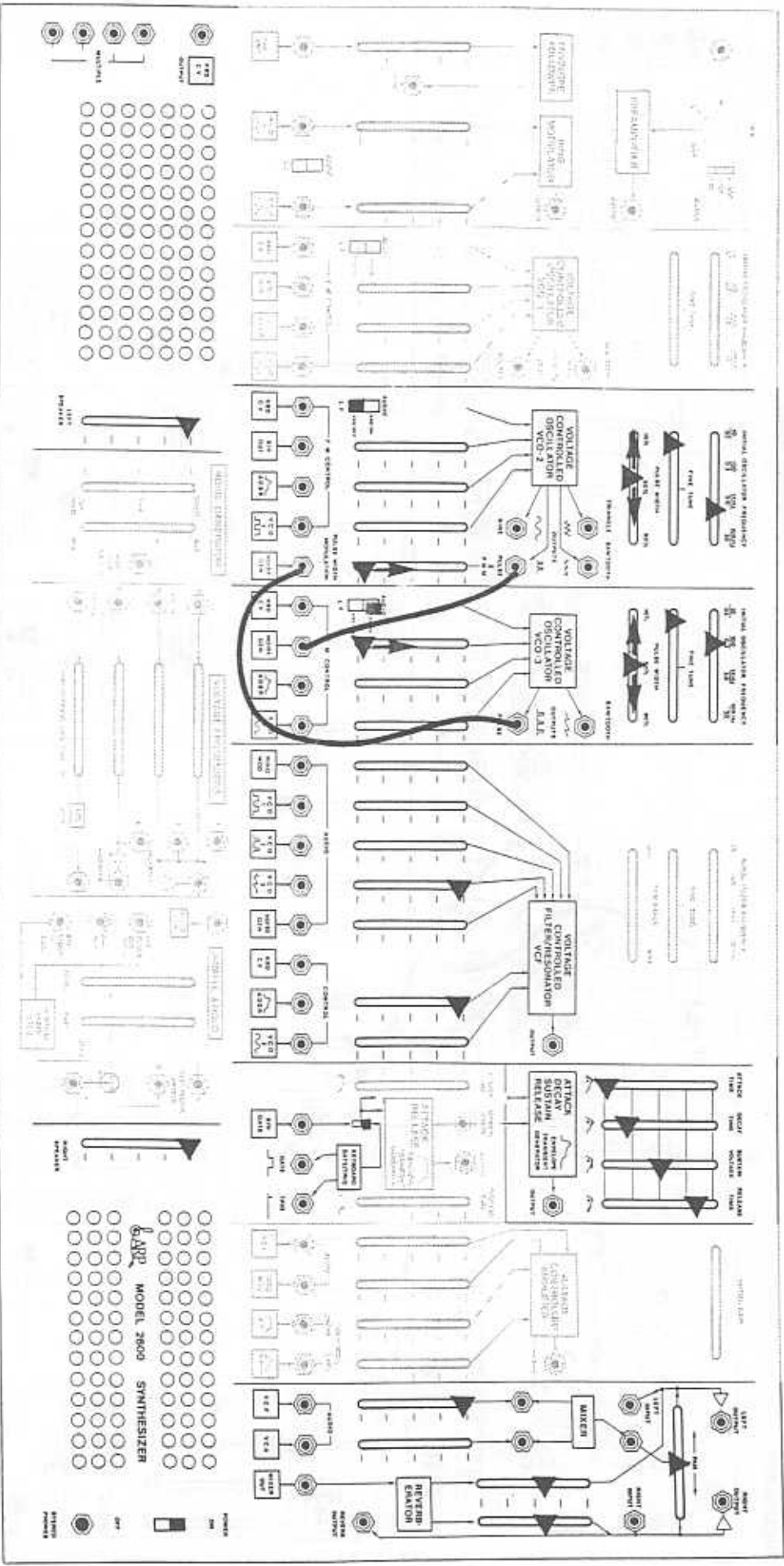
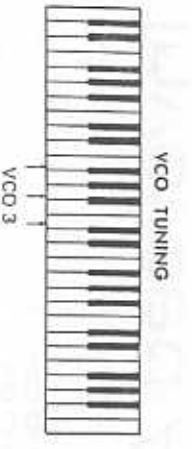

1. Raise 1 into VCO 3, tuning interval to a fifth.
2. Raise 1 into VCO 2 for appearance of middle pitch.
3. Adjust VCO 2 Pulse Width for desired rhythm.
4. Tune middle note to a major third above bottom pitch with VCO 3 Pulse Width slider.

# Three-note Tunable Sequence

Handwritten text, possibly bleed-through from the reverse side of the page. The text is illegible due to blurriness and orientation.

Handwritten text, possibly bleed-through from the reverse side of the page. The text is mostly illegible due to fading and bleed-through.

Handwritten text at the top of the page, possibly a name or title.

Handwritten text at the bottom of the page, possibly a date or signature.

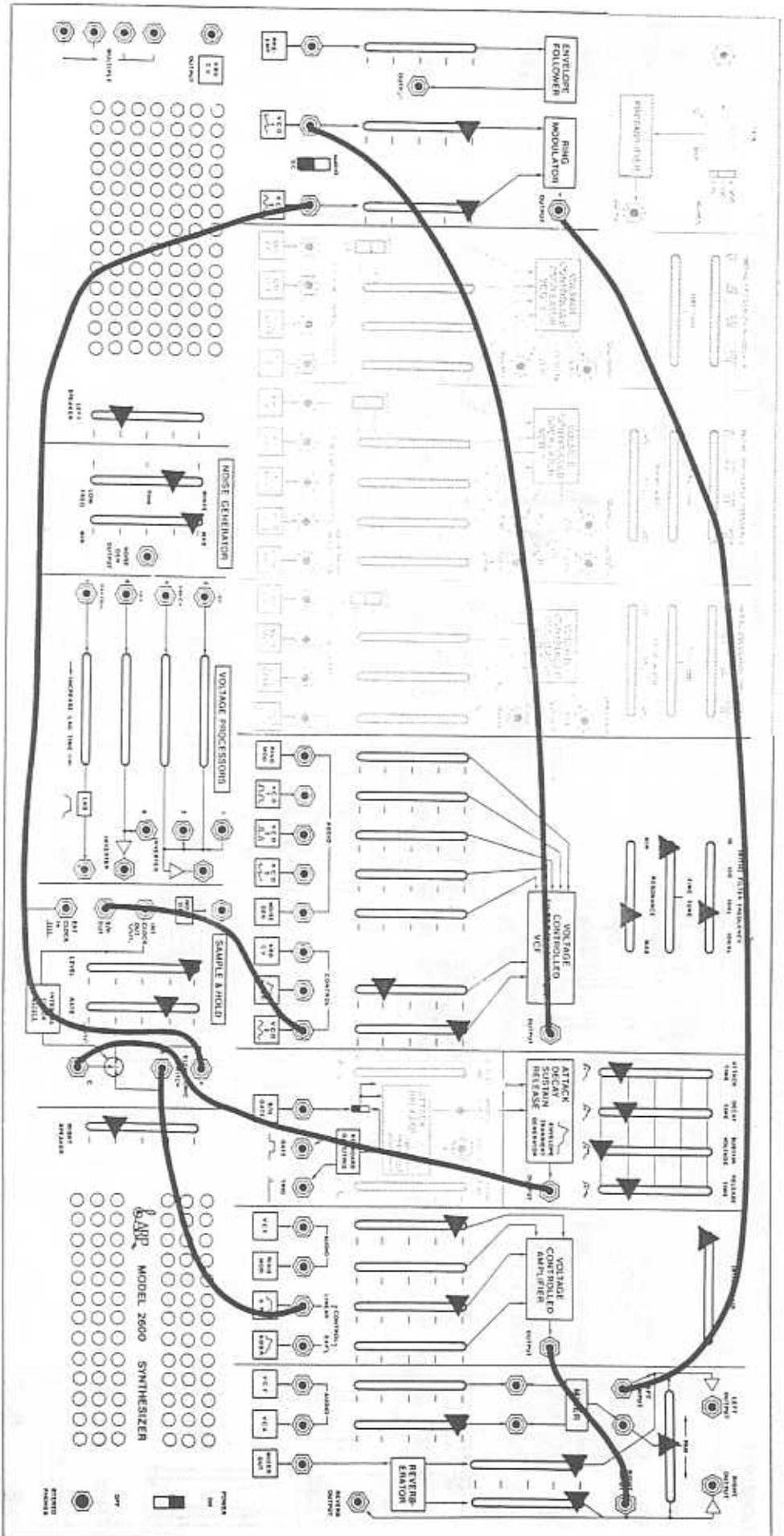

7 PATCHCORDS

Stereo Chickadee Conversation

61.



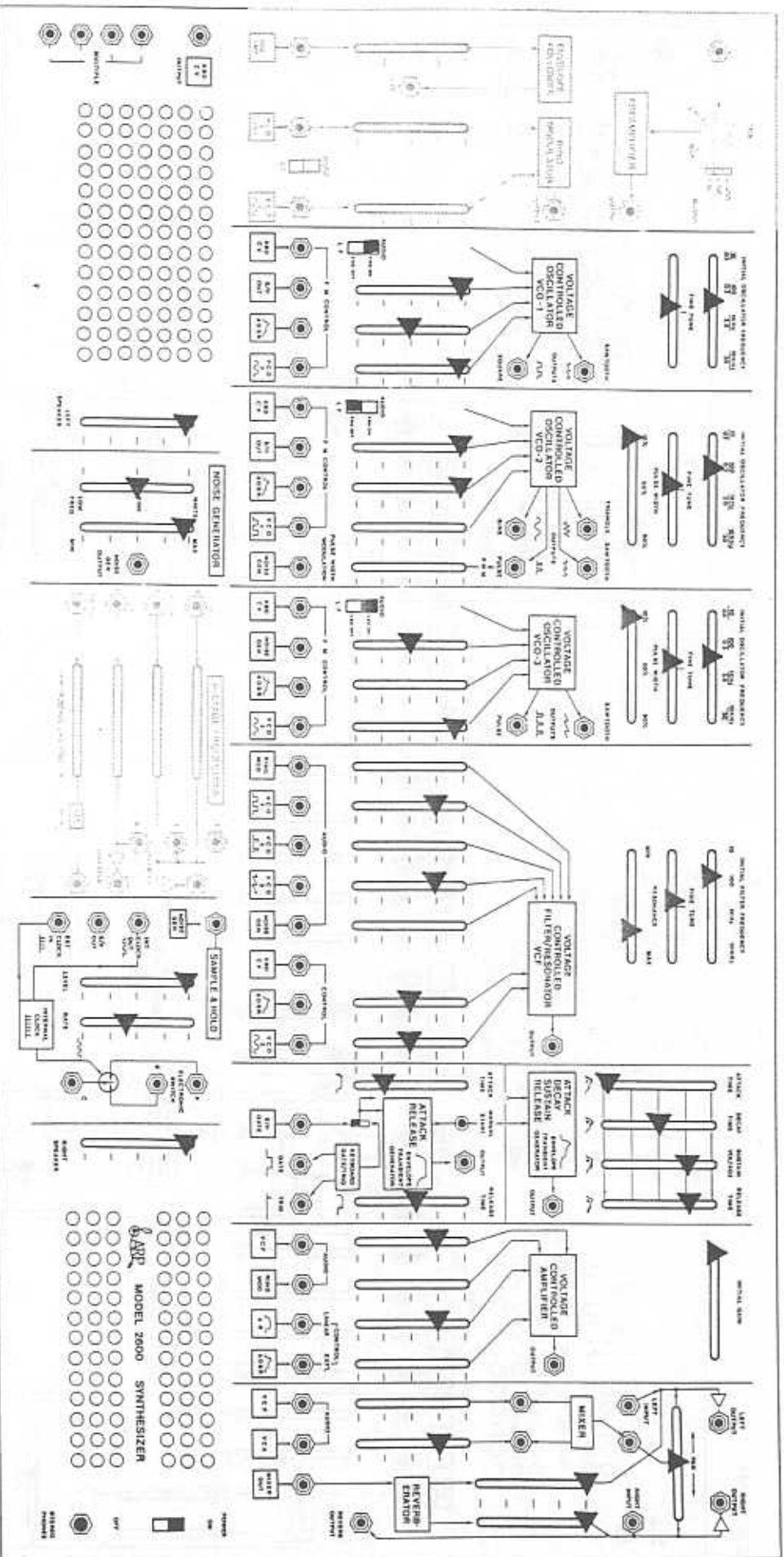

Playing different keys will produce different timbres.

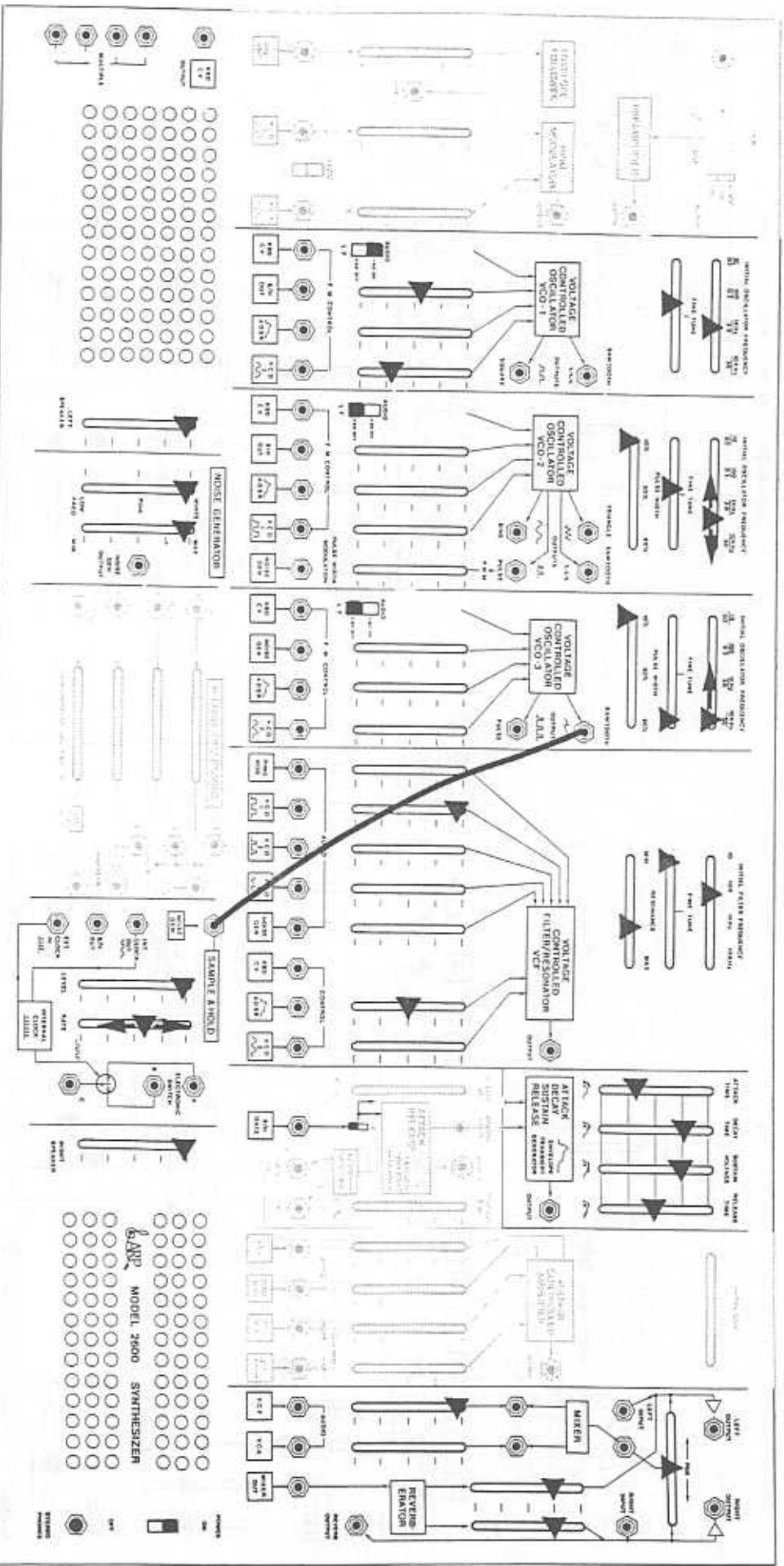

Adjust:

- VCO 3 frequency for patterns
- VCO 2 frequency for vibrato speed
- S/H Rate for whistle speed

PLAY KEY C2

1 PATCHCORD

# Random Whistler

# 57.



THUNDER

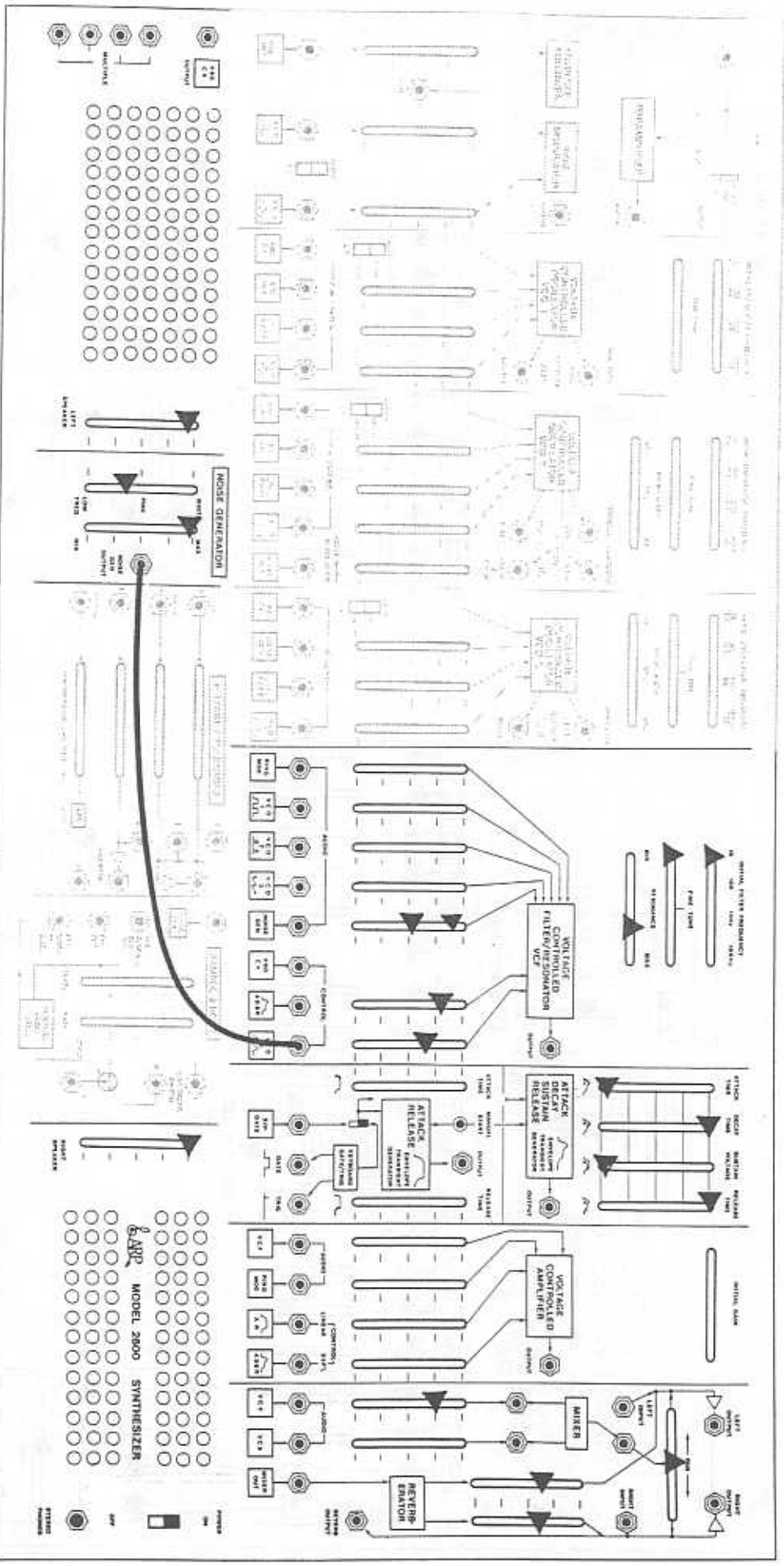

PLAY KEY C5

1 PATCHCORD

# Clapping Thunder

# 55.



53.0354.010

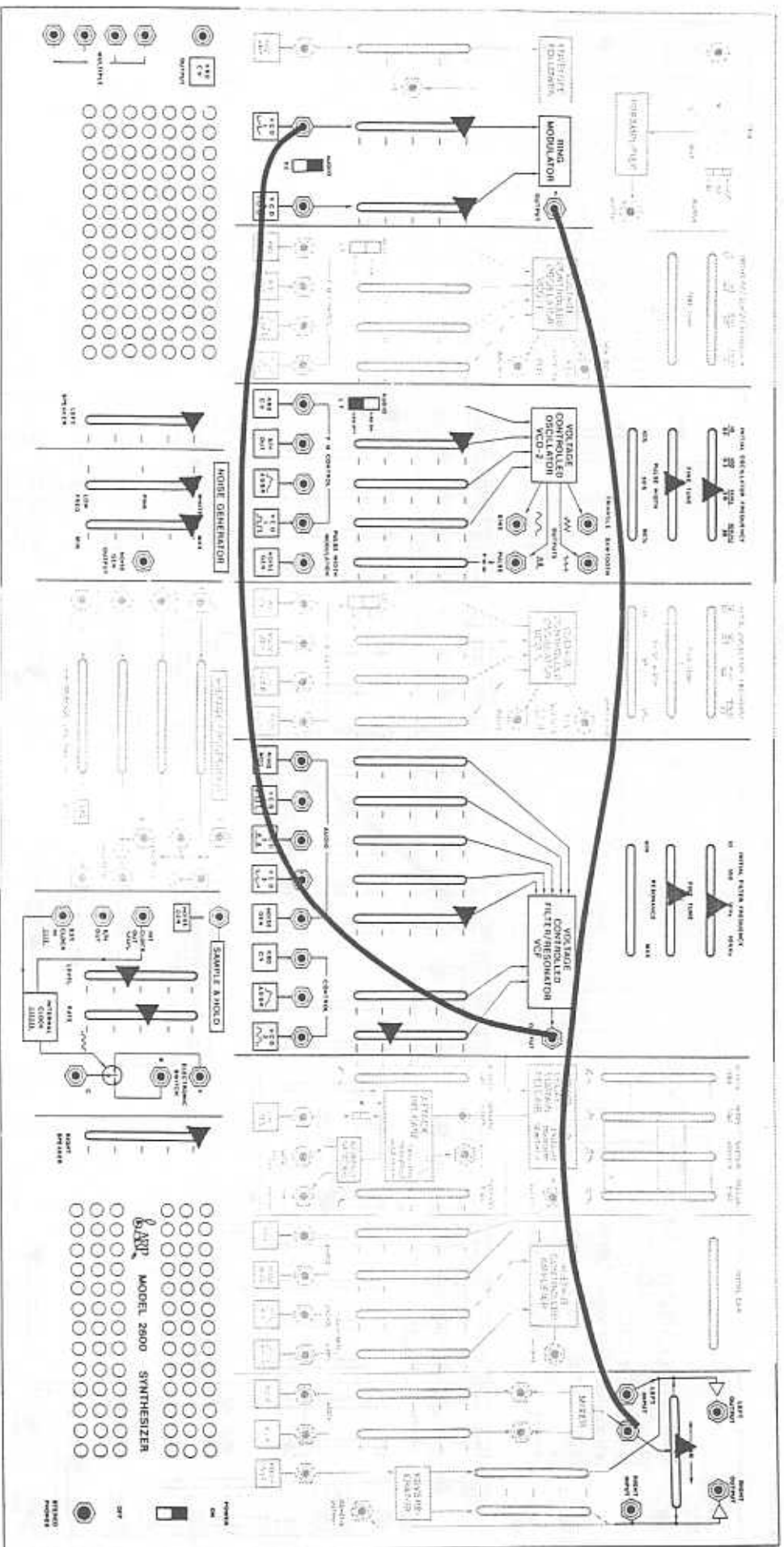

2 PATCHCORDS

# Sporadic Heavy Breathing

53.





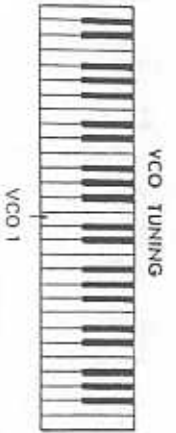

VCO TUNING

VCO 1

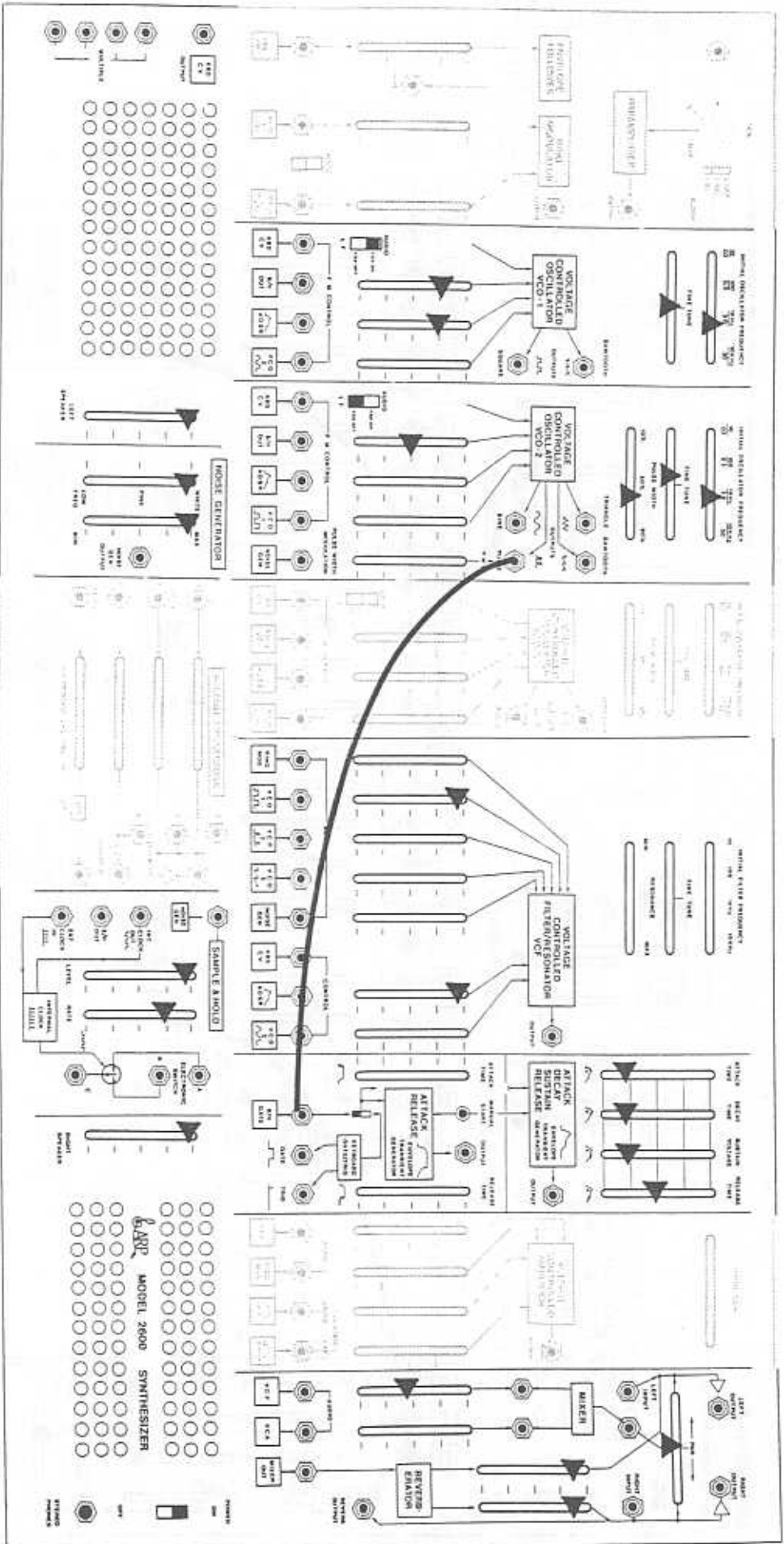

1 PATCHCORD

Arboretum

51.



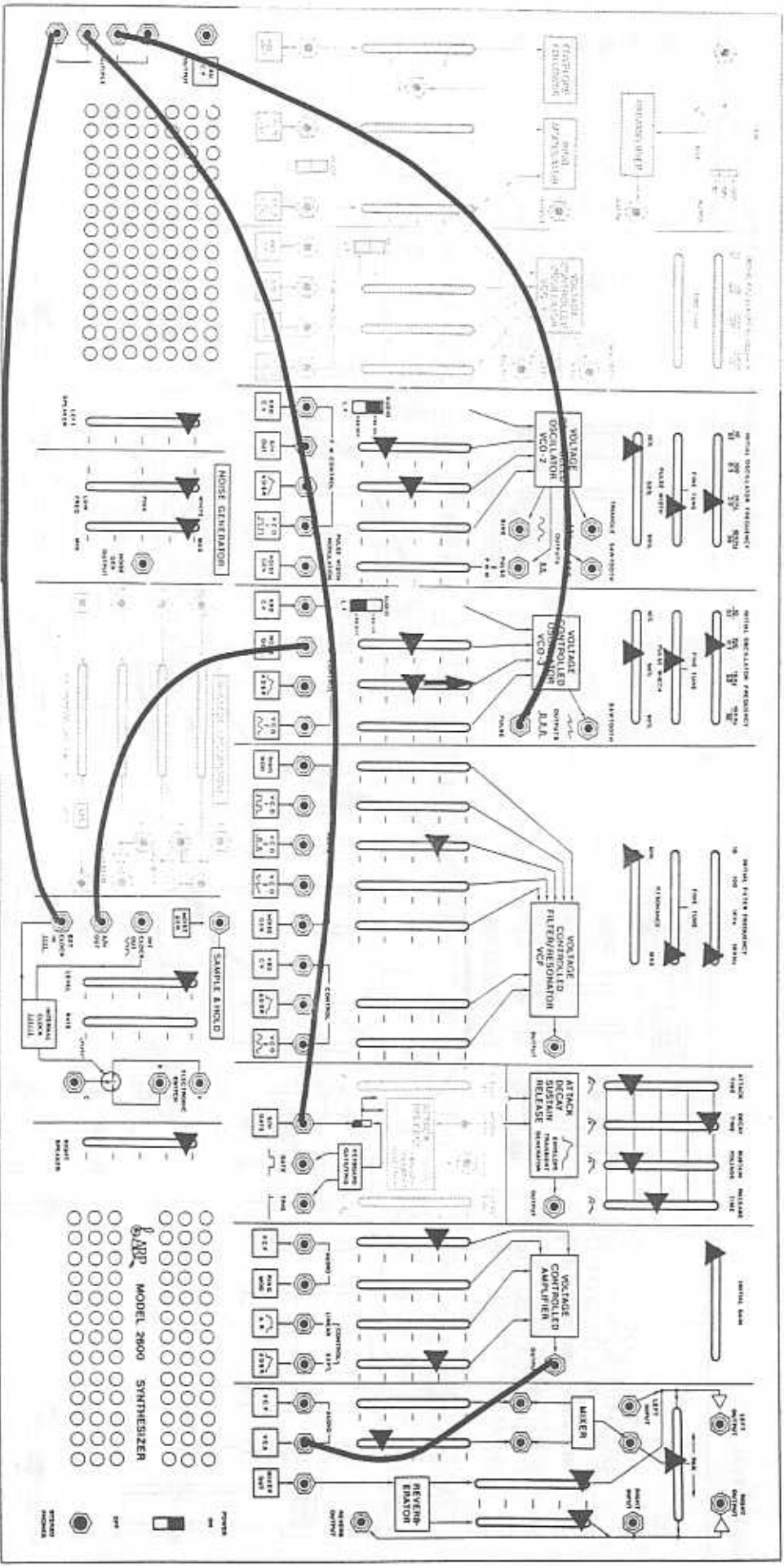

Note:  
 VCO 3 Pulse Width determines final decay time.  
 Raising ADSR into VCO 3 induces a state of  
 confusion in seagulls.  
 Use any note on keyboard for 'tuning' of birds.

5 PATCHCORDS

Edinburgh City Council

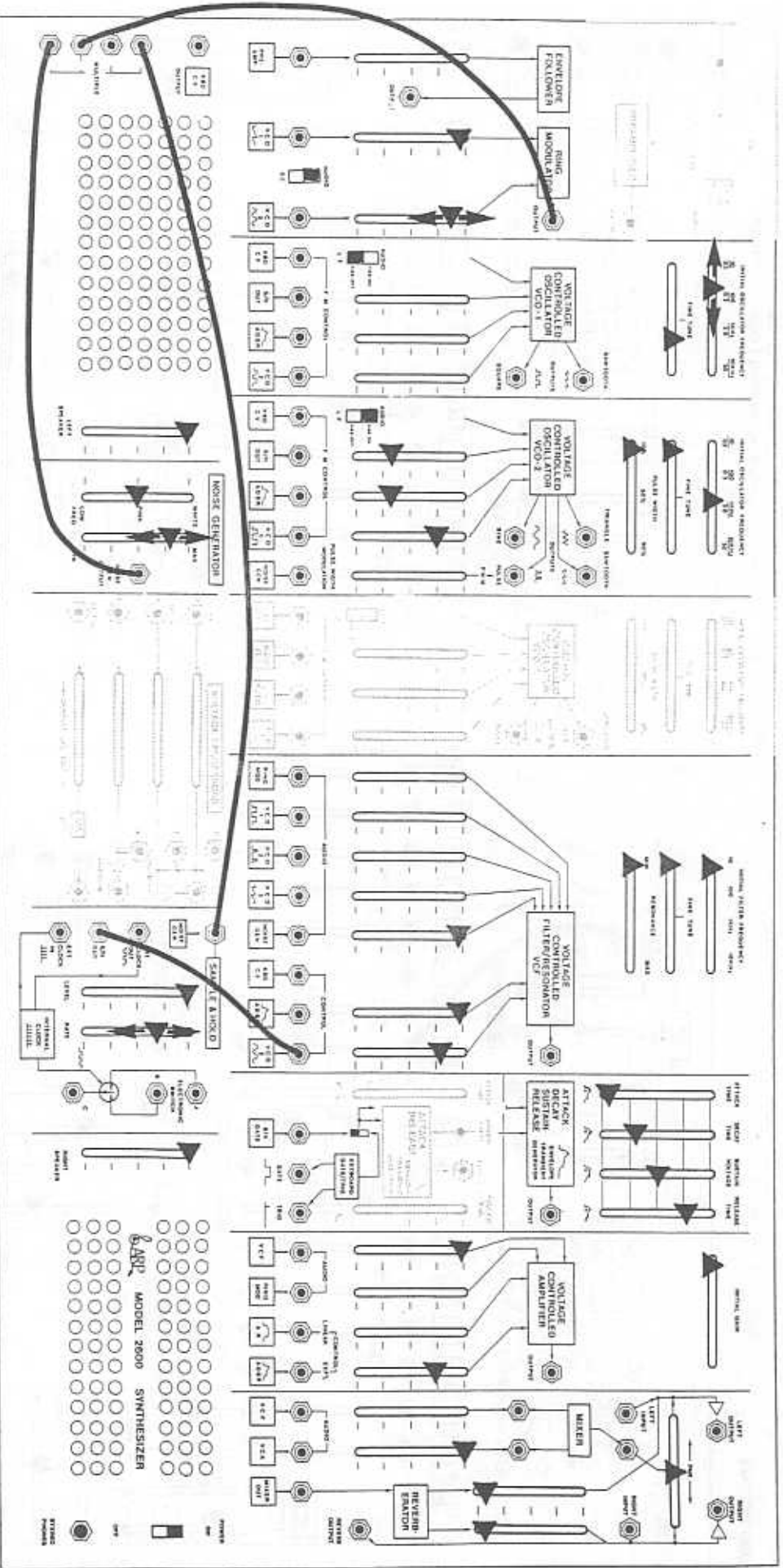

Adjust:  
 VCO 1 Frequency for 'solo' length.  
 VCO 2 ~~~~~ | at Ring Mod for Conga volume.  
 Noise Max/Min Slider for snare volume.  
 S/H Rate for tempo.

PLAY KEY C1

# Conga & Snare Duet

4 PATCHCORDS

# 47.



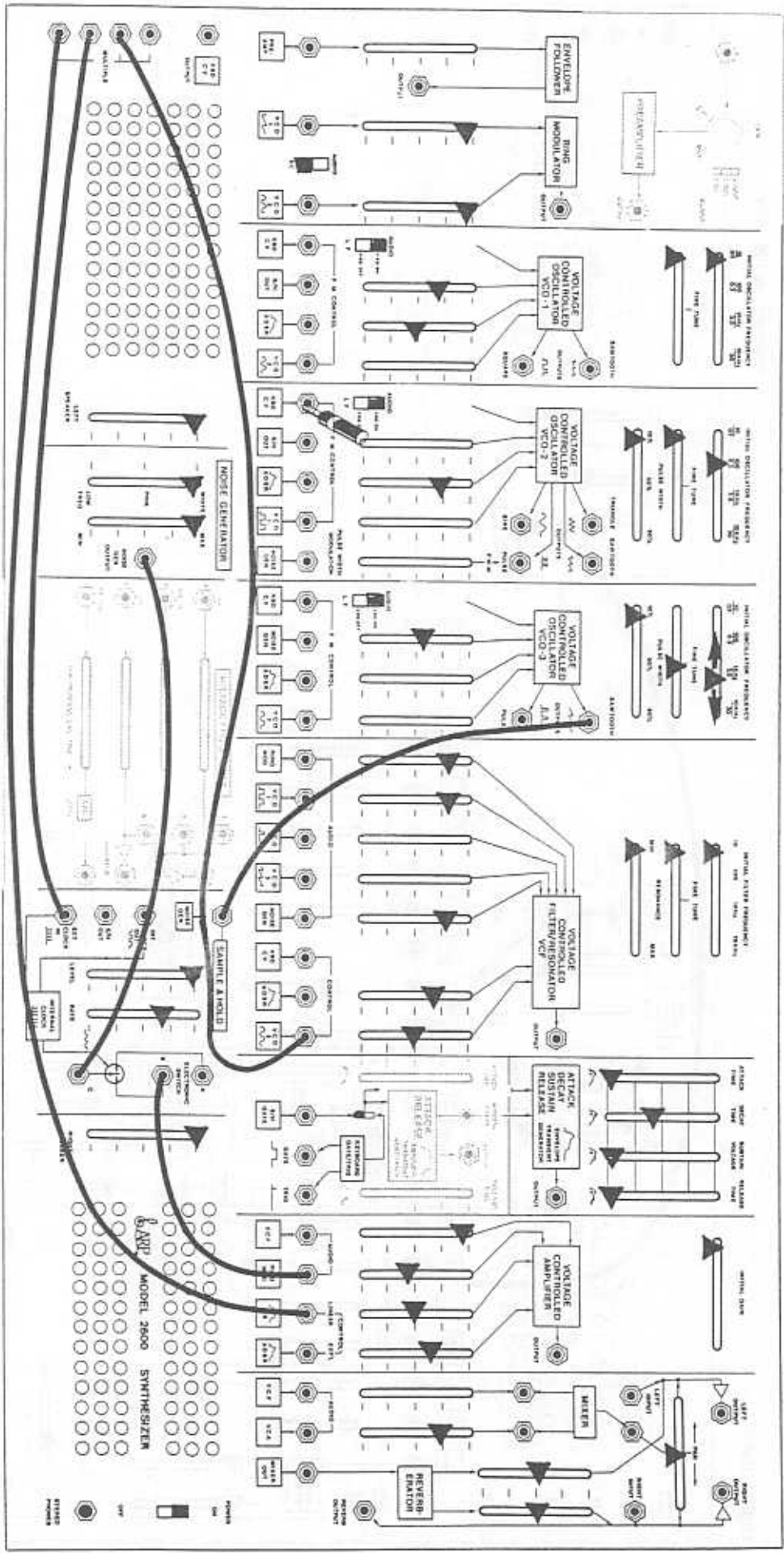

Hit Key C1 for proper range.  
 Adjust VCO 3 frequency for different patterns.  
 Adjust S/H Rate for tempo.

6 PATCHCORDS  
 1 DUMMY PLUG

# Back-beat: Bass Drum, Hi-hat & Tom 45.



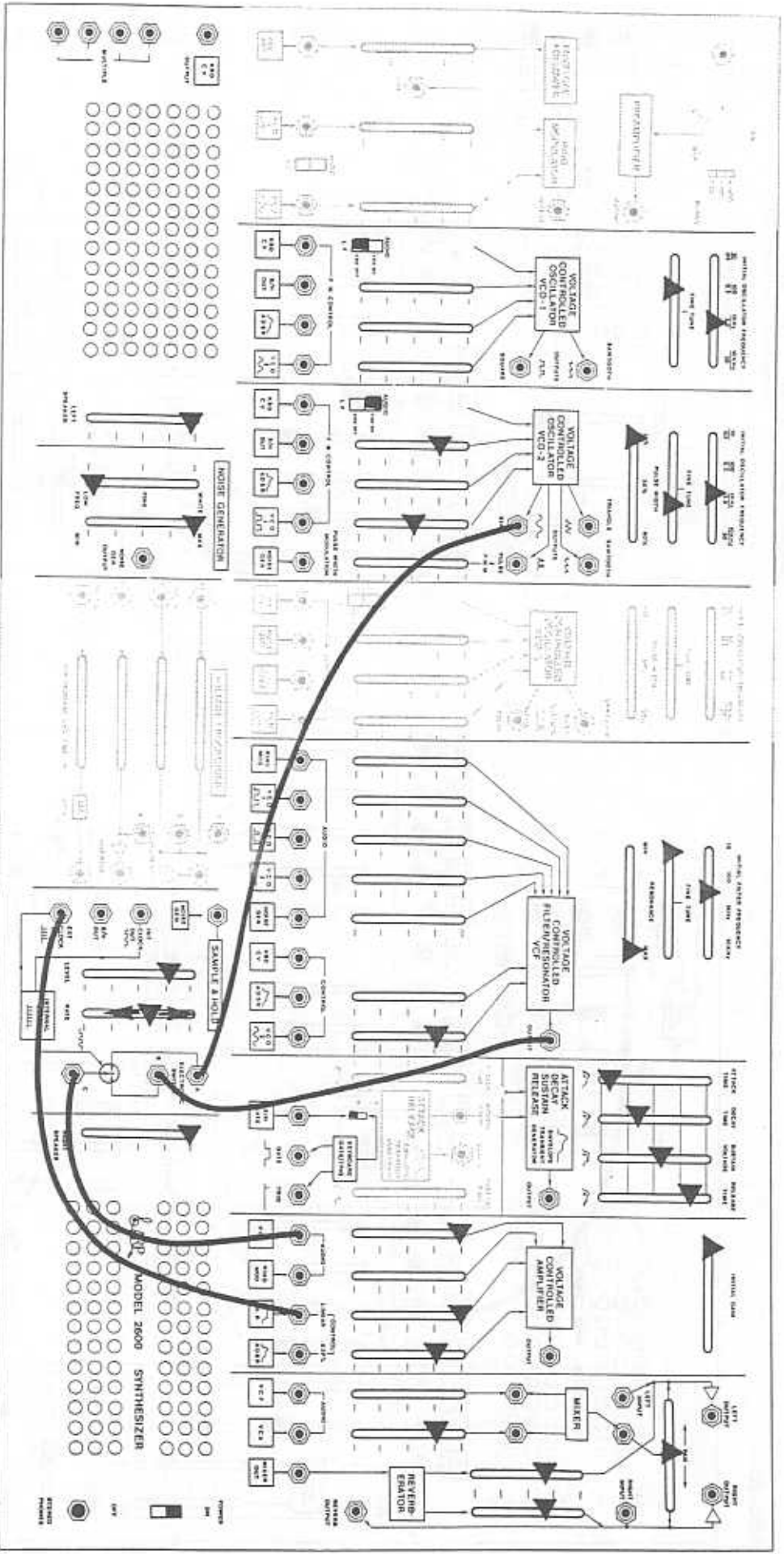

Adjust S/H Rate for tempo.  
Play up and down keyboard for different timbres.

4 PATCHCORDS

Advanced Steel Drum Corps

43.



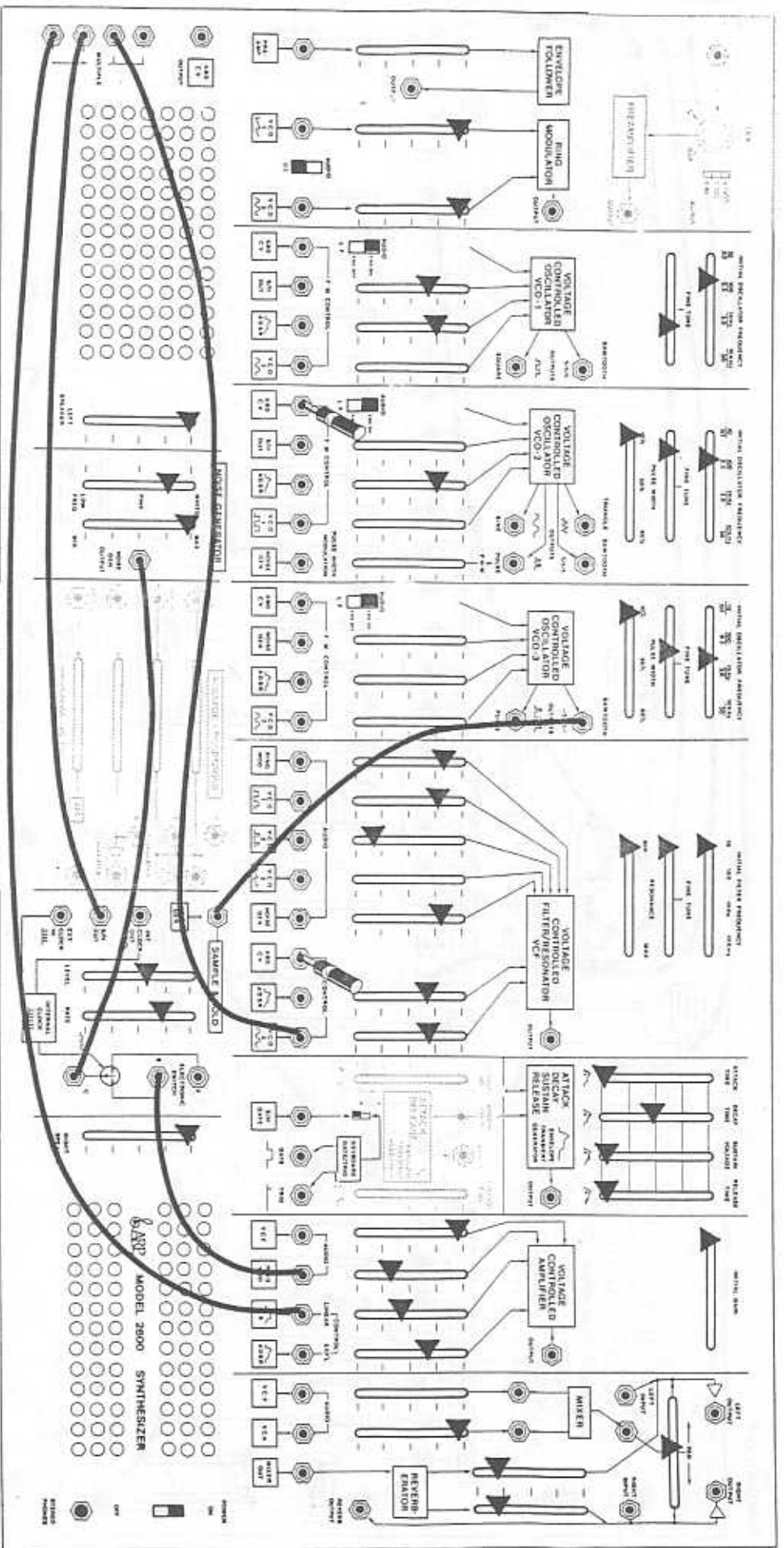

# Tom & Hi-hat Duet

6 PATCHCORDS  
2 DUMMY PLUGS

# 41.



EMULATED BY THE GIBSON GIBSON

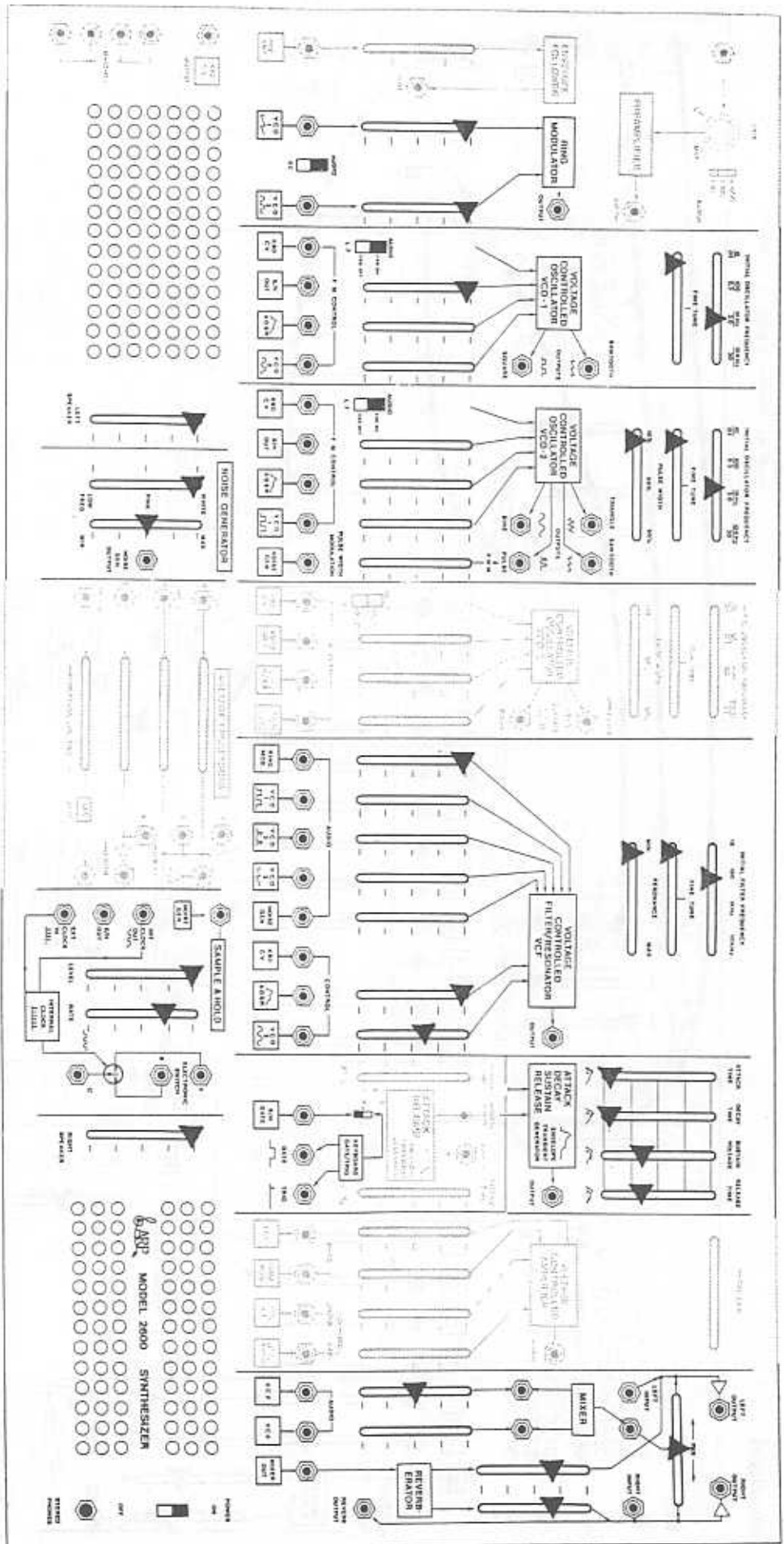

Tune VCO 1 and 2 for different timbres.

Metallic Thunks

39.





Handwritten text, possibly a signature or name, oriented vertically on the right side of the page.

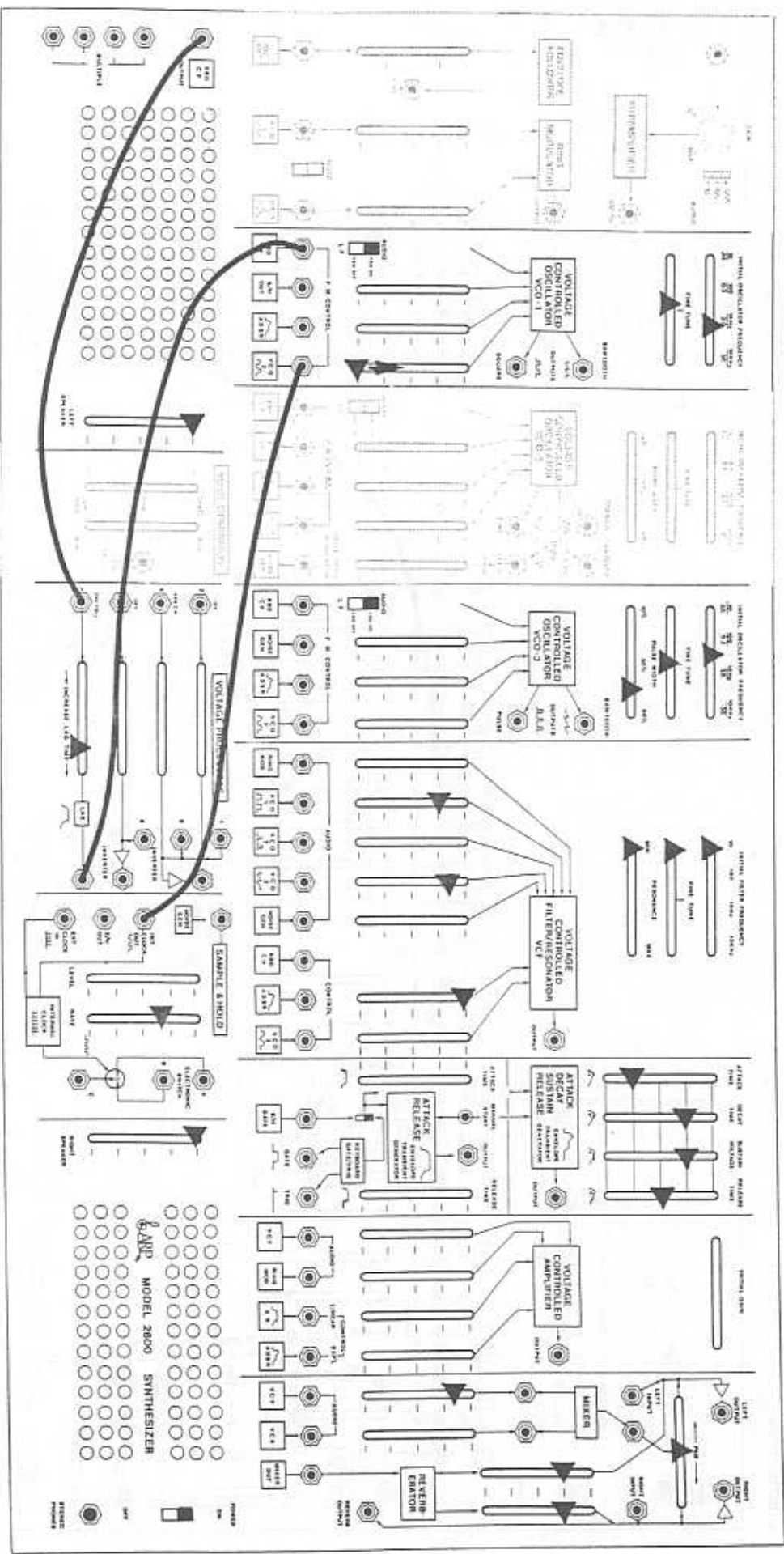

1. Tune VCO 3 to middle C.  
VCO 1 to two octaves above middle C.
2. Raise VCO 1 into VCO 1 and adjust S/H Rate for vibrato speed.
3. Note: Whistle will have vibrato and glide; Trumpet is straight.

3 PATCHCORDS

# Pennywhistle & Trumpet

# 36.



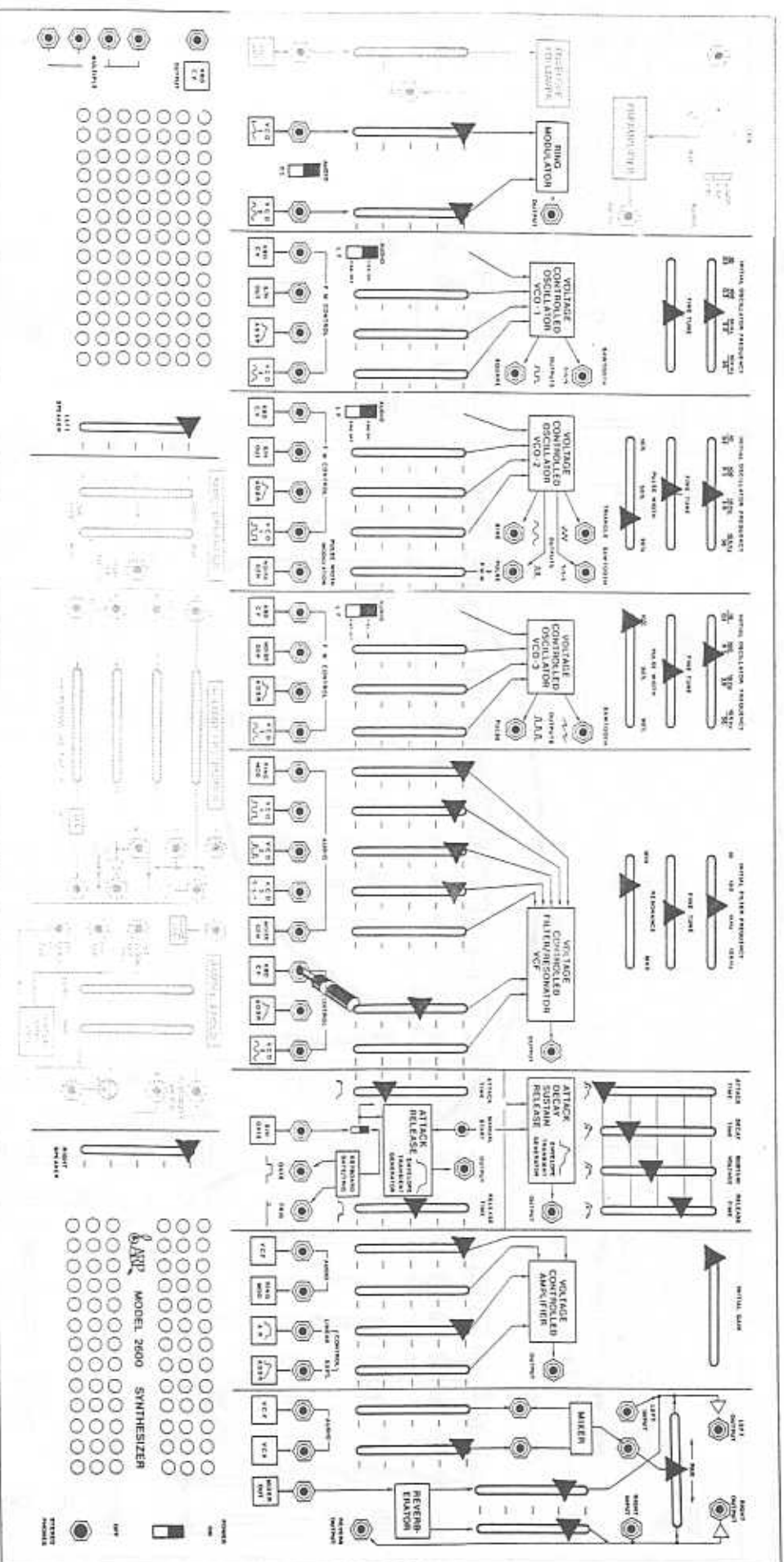

Follow tuning instructions detailed in the Introduction.

Lead lines are to be played on the top keys.

Minor chords can be heard on the bottom keys.

# Marimba: Chords & Lead



VCO 2  
VCO 1 VCF

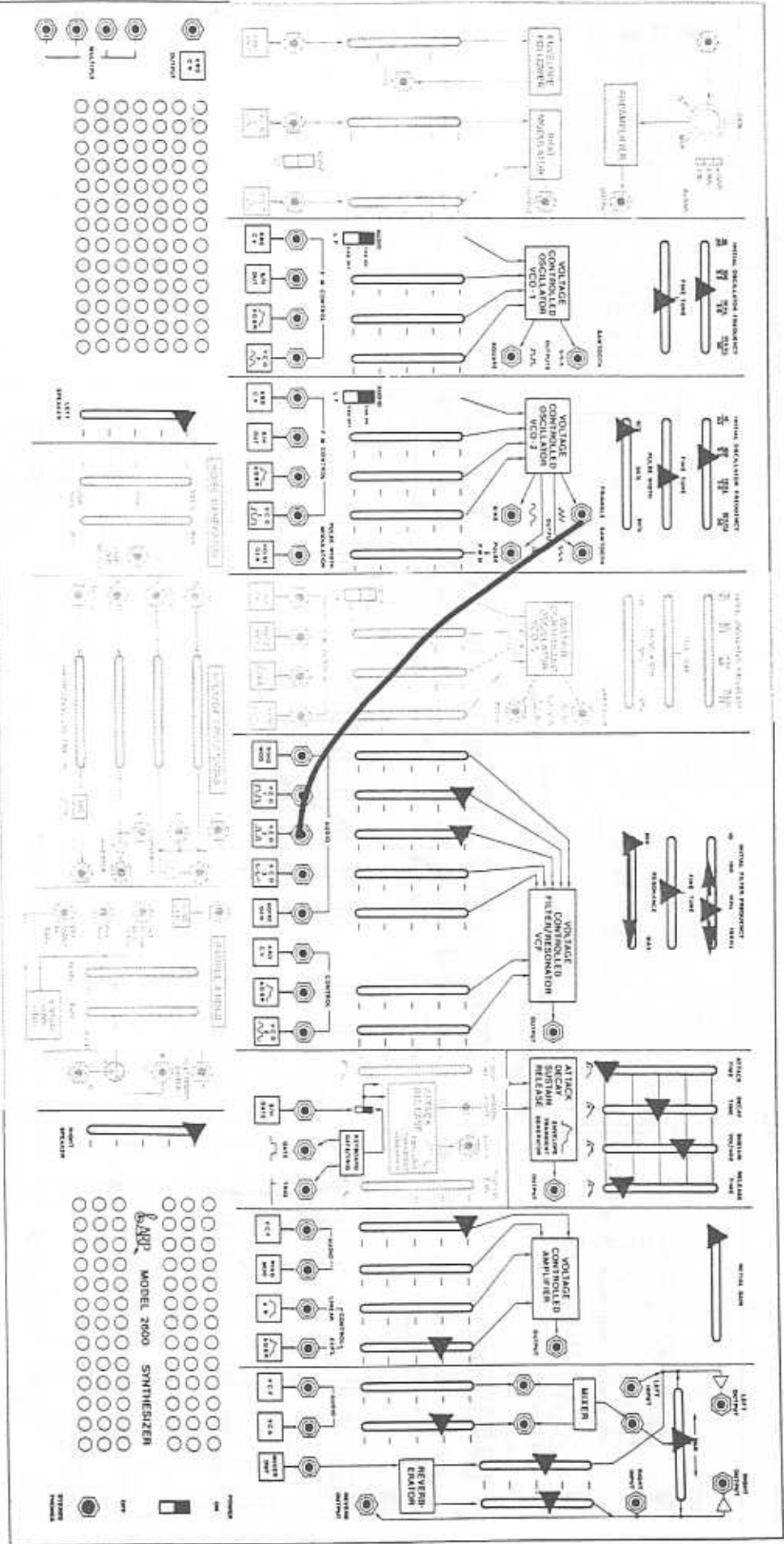

1. Open VCF — and tune VCO 1 to one octave below middle C. Tune VCO 2 to two octaves below middle C.
2. Open Resonance — and tune VCF — to a fifth above VCO 1.

1 PATCHCORD

Zombie Organ



32.

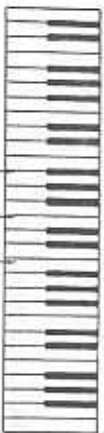

VCO TUNING

VCO 1 VCO 3 VCO 2

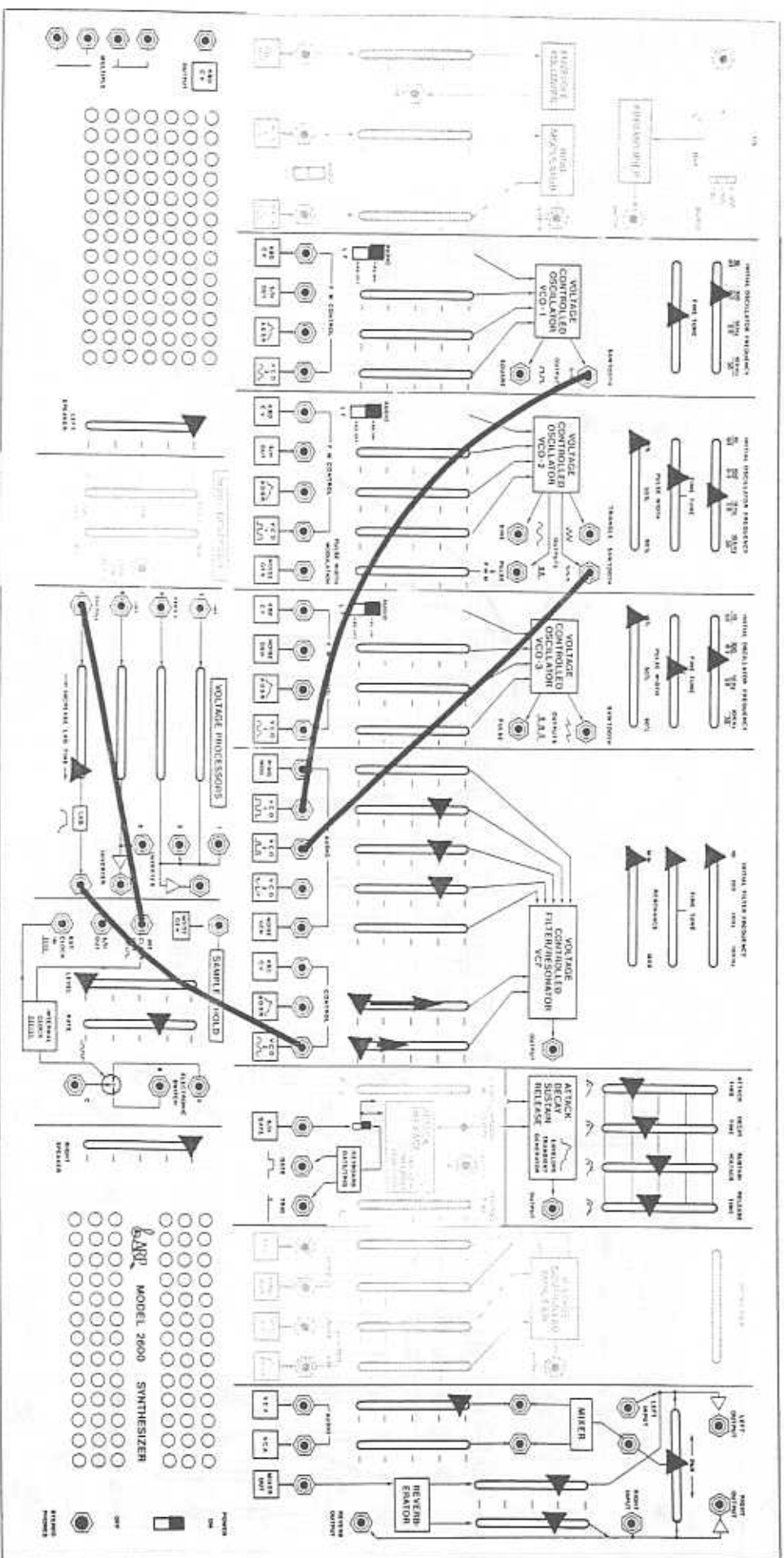

1. Tune: VCO 3 to a fourth above middle C (to F), VCO 2 to a fourth below middle C (to G), VCO 1 to a fourth above middle C (to F).
2. Raise ADSR into VCF for brightness.
3. Raise into VCF and adjust S/H Rate for tremolo speed.

4 PATCHCORDS

Big Band Brass

30.



VCO TUNING

VCO 1+3

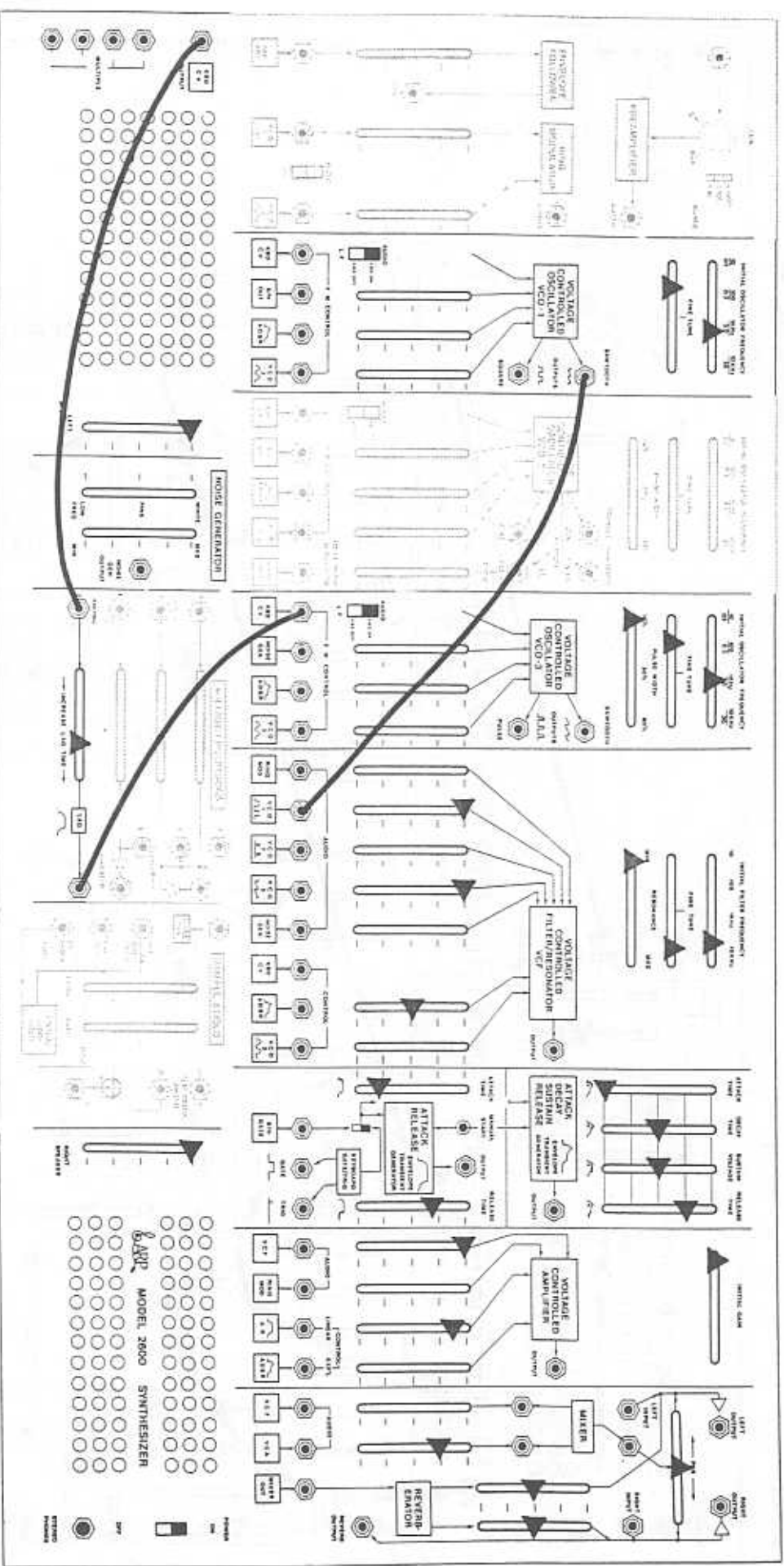

1. Tune VCO 1 and 3 to an octave above middle C.
2. Adjust Lag — for desired keyboard delay.



Portamento

3 PATCHCORDS

# Oriental String Duo

# 28.



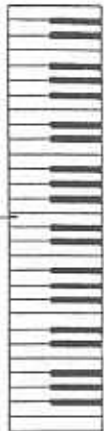

VCO TUNING

VCO 3

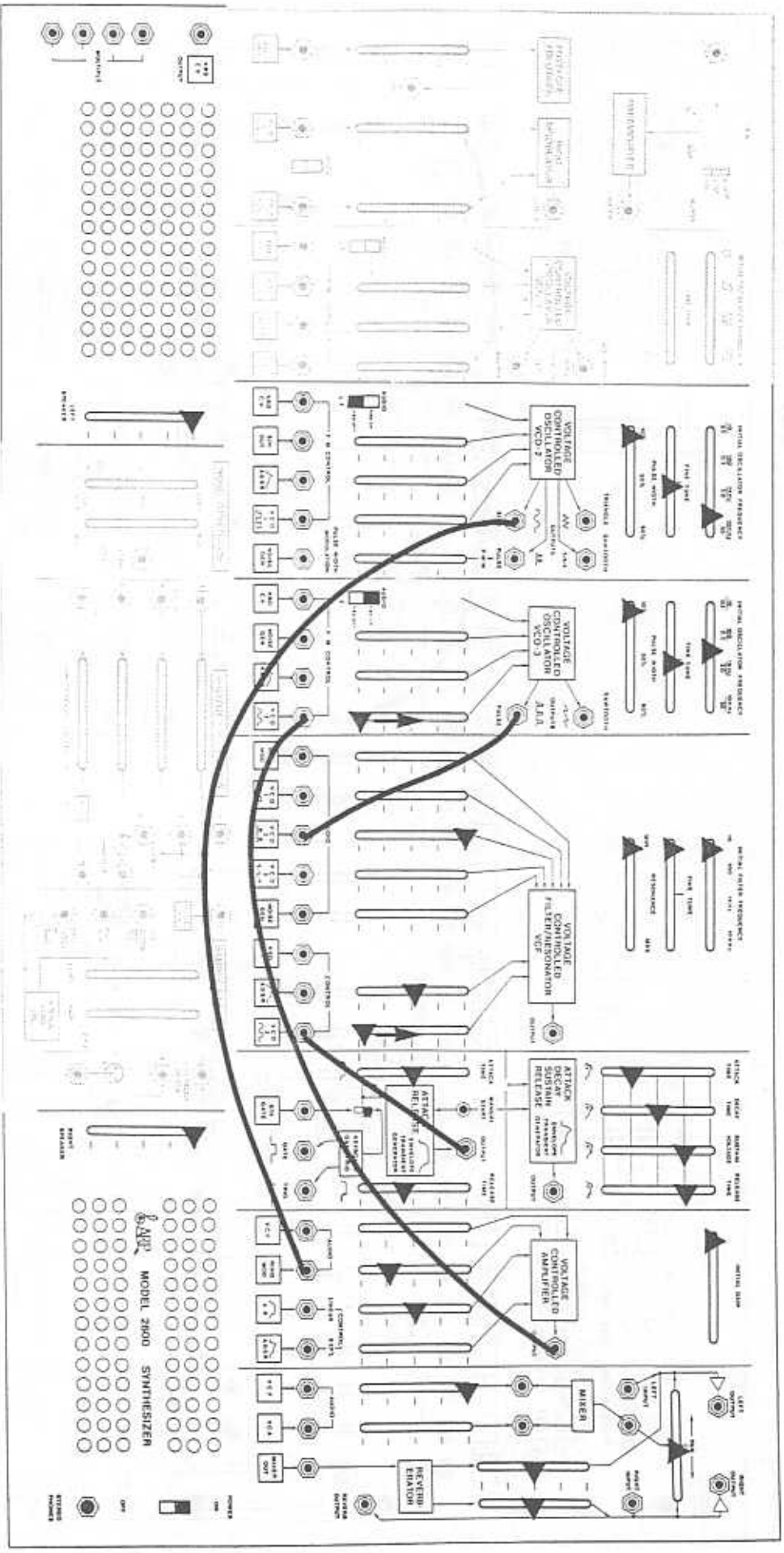

1. Tune VCO 3 to middle C.
2. Raise | into VCO 3 and adjust VCO 2 frequency for vibrato speed.
3. Raise | into VCF for delayed brilliance.

4 PATCHCORDS

Doc Trumpet

26.



VCO TUNING



VCO 2 VCO 3

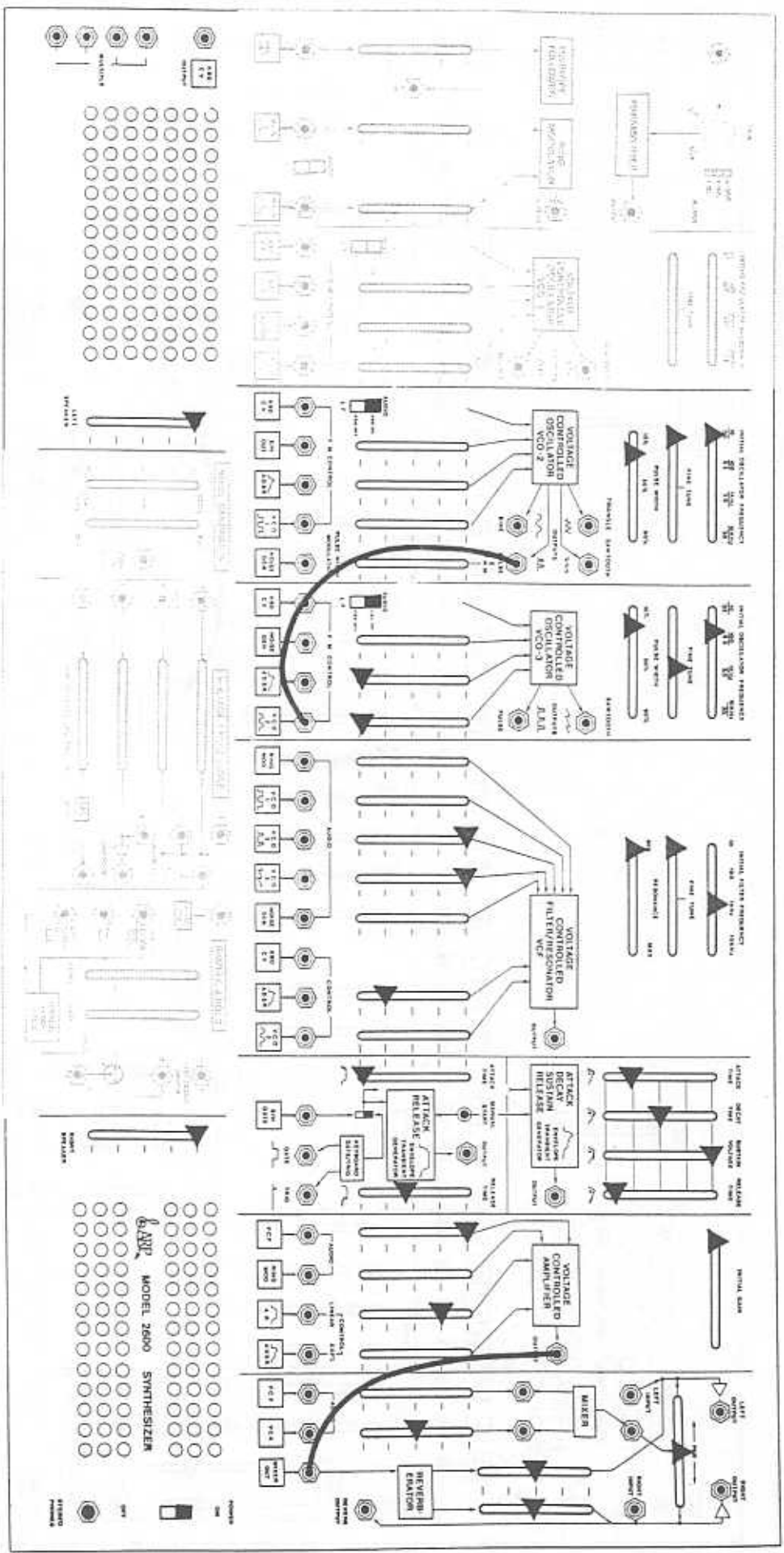

Tuning

1. Play Key C3 and tune VCO 3 to an octave above VCO 2, which is tuned as shown.
2. Raise VCO 2 fully into VCO 3.
3. Raise ADSR fully into VCO 3 until a solid tone without beats is heard.

(Pitch Bender)

# Heavy Metal Fuzz Lead

2 PATCHCORDS

# 24.







VCO TUNING

VCO 2

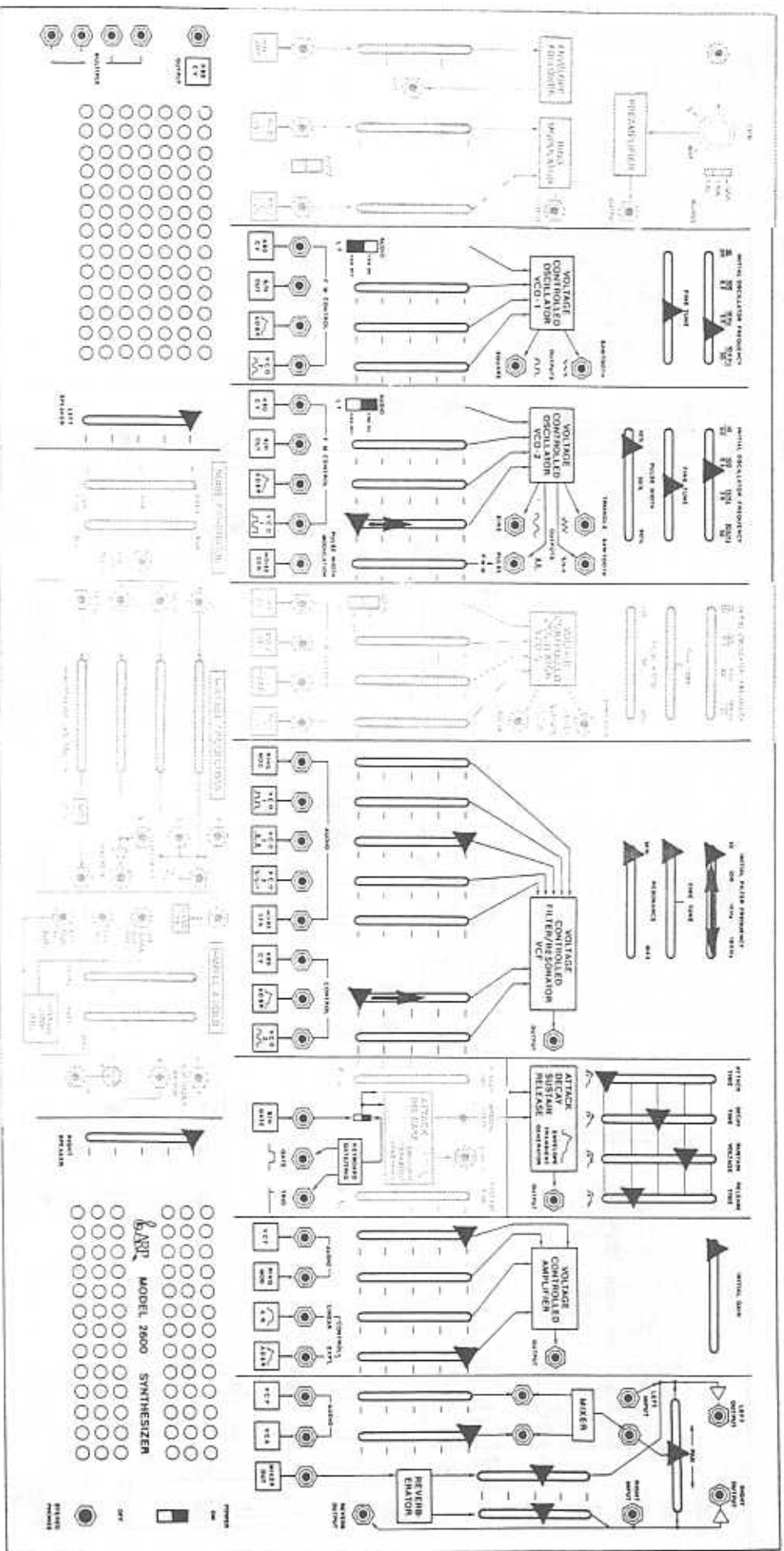

1. Open VCF — and tune VCO 2 to middle C.
2. Close VCF — and raise ADSR | into VCF.
3. Raise VCO 1 | into VCO 2 and adjust VCO 1 frequency for trill speed.
4. Bring VCO 1 | in and out of VCO 2 during performance for trills.

Jazz Guitar



22.

## VCO TUNING



VCO 3

**VOLTAGE CONTROLLED OSCILLATOR VCO-1**

**VOLTAGE CONTROLLED OSCILLATOR VCO-2**

**VOLTAGE CONTROLLED OSCILLATOR VCO-3**

**VOLTAGE CONTROLLED FILTER/RESONATOR VCF**

**ATTACK SUSTAIN RELEASE ASR**

**REVERB ERATOR**

**ARP MODEL 2000 SYNTHESIZER**

**1 PATCHCORD**

1. Open VCF — and tune VCO 3 to one octave above middle C.
2. Close VCF — and raise ADSR ↑ into VCF for brightness.
3. Raise VCO 2 ↓ into VCF for tremolo.
4. Adjust VCO 2 frequency for tremolo speed.

Flute

20.

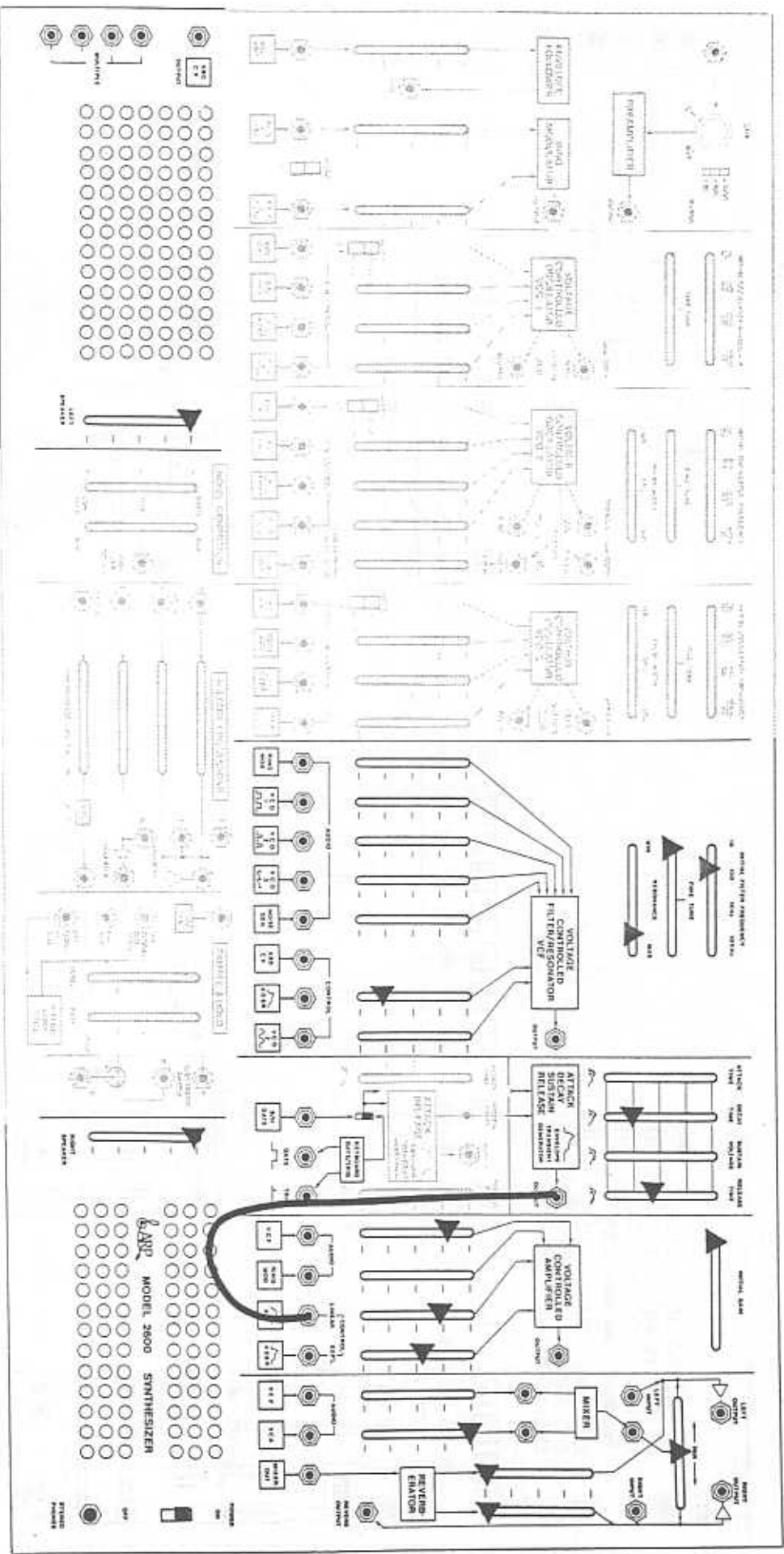

1 PATCHCORD

# Big Bass Drum

# 18.



VCO TUNING

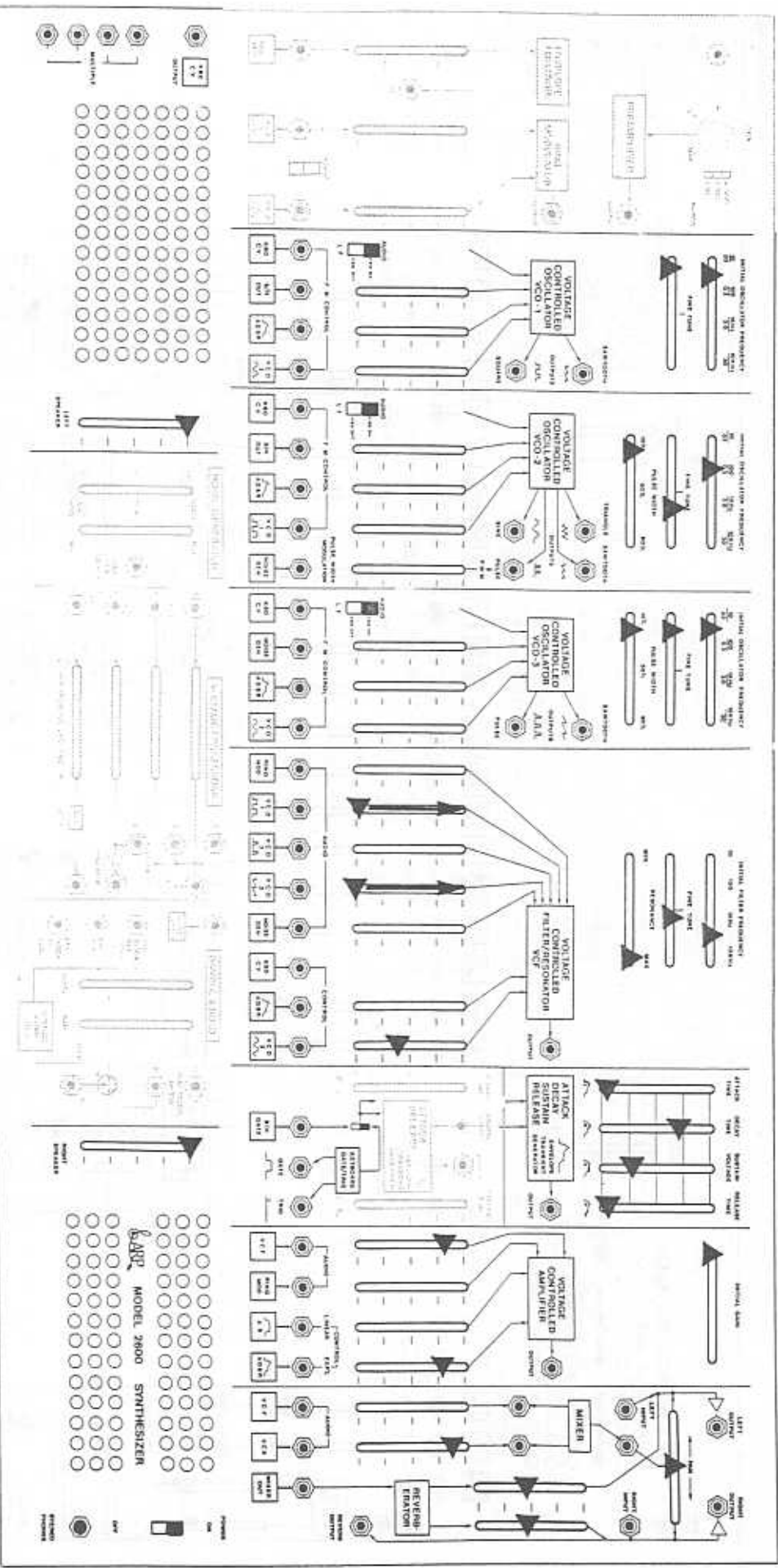

OPTION: Raise VCO 1 | or VCO 3 | into VCF.  
Tune to one octave below VCO 2

# Electric Mouth-harp

# 16.



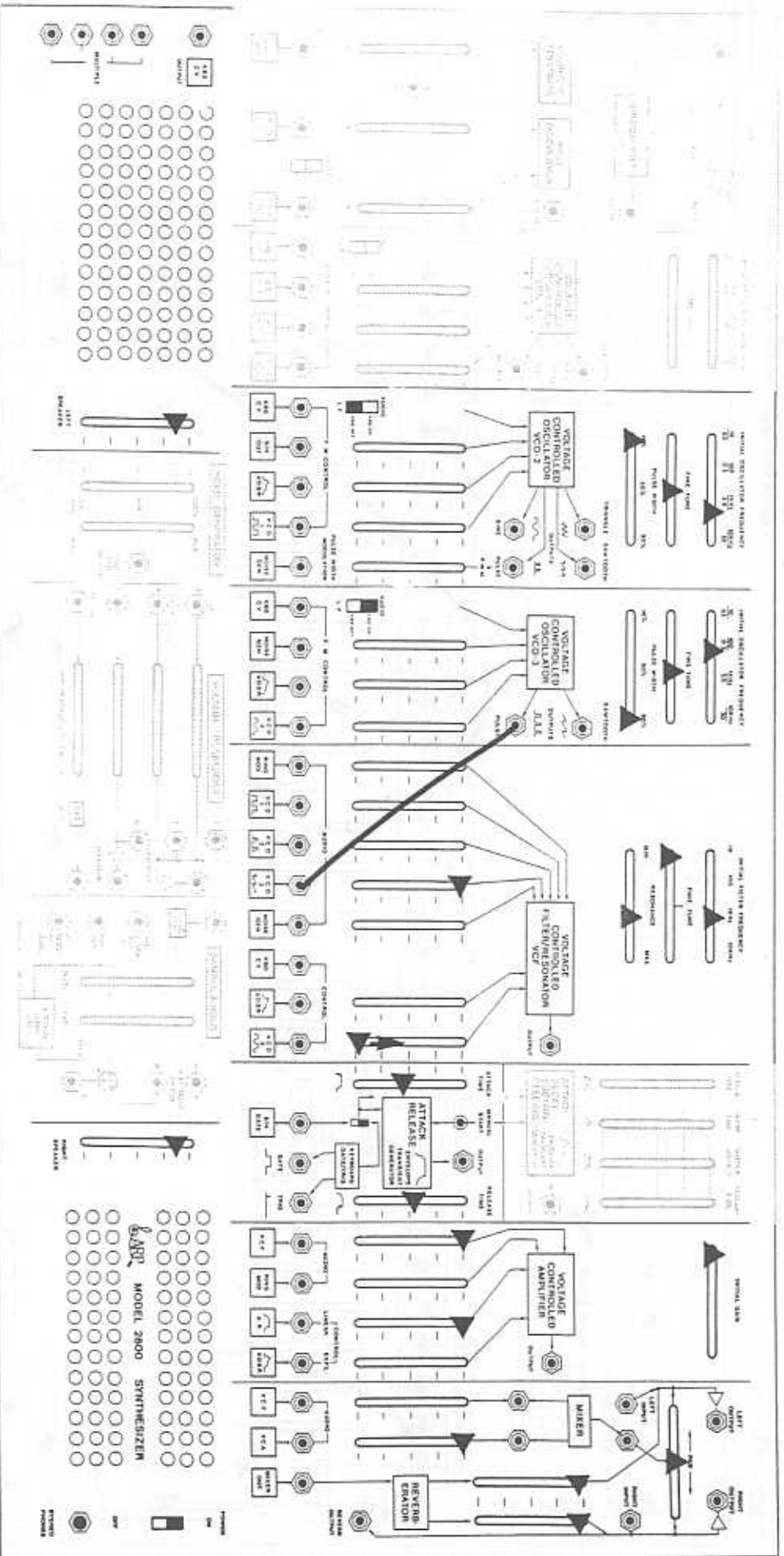

1. Tune VCO 3 to middle C.
2. Raise VCO 2 1/2 into VCF and adjust VCO 2 frequency for tremolo speed.

Cowboy Harmonica

14.



VCO TUNING

VCO1

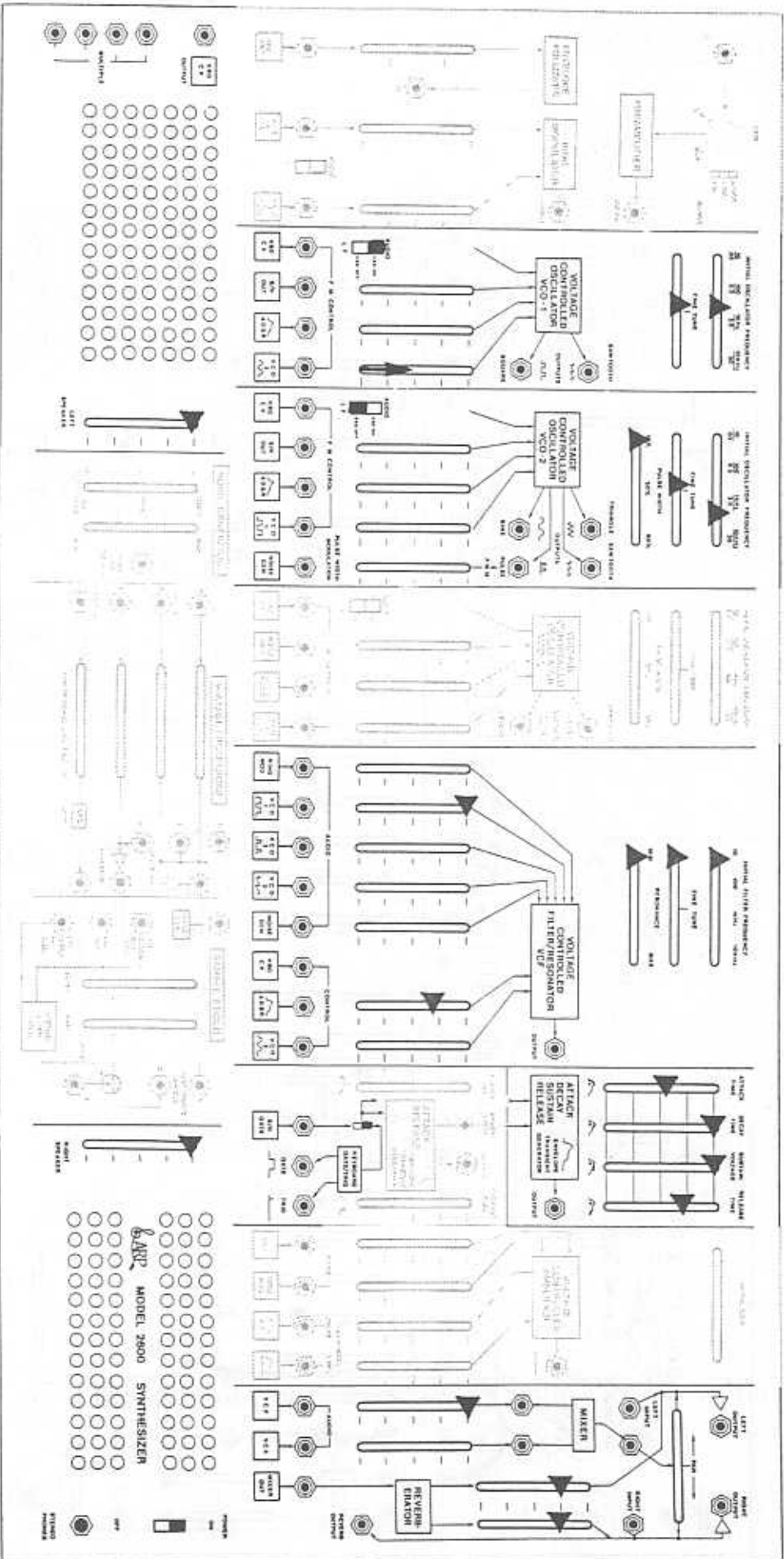

Portamento

1. Tune VCO 1 to middle C.
2. Raise VCO 2 | into VCO 1 and adjust VCO 2 frequency for vibrato speed.



Thereminovox



12.



VCO TUNING

VCO 2

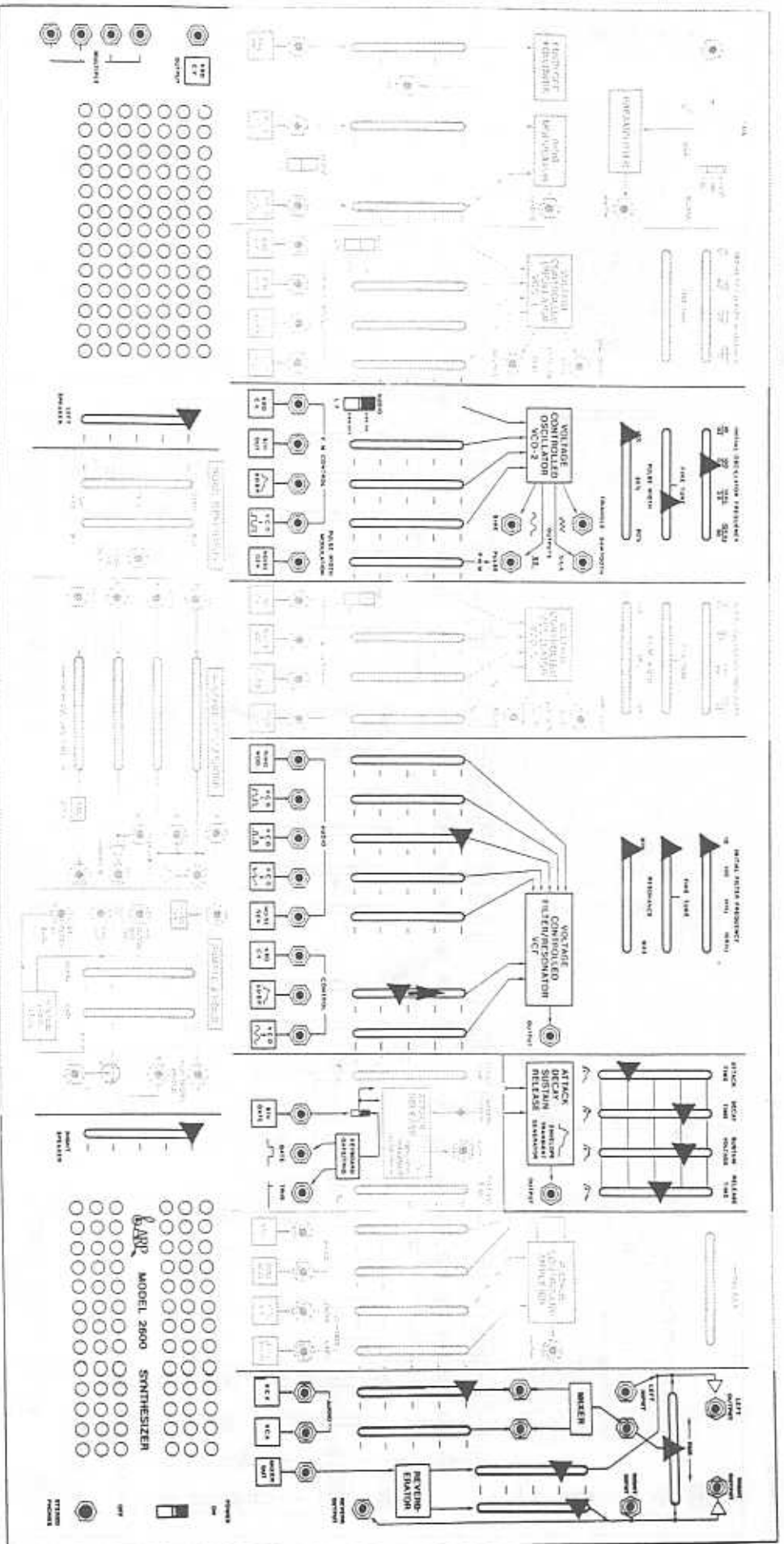

1. Tune VCO 2 to middle C.
2. Raise ADSR ↑ into VCF Control for brightness.

# Fanfare Trumpet

10.







VCO TUNING

VCO 3

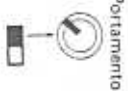
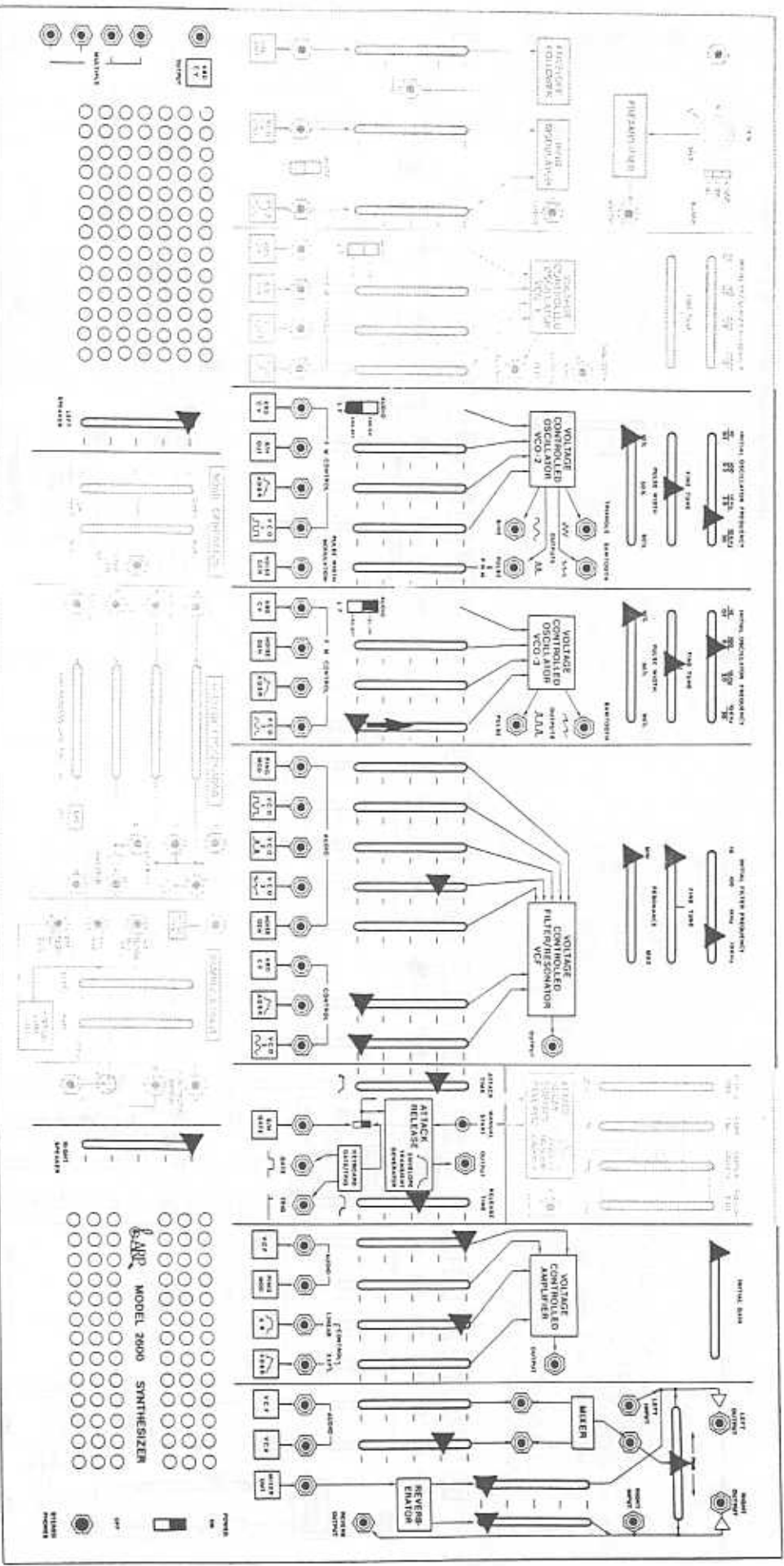

- Portamento
1. Tune VCO 3 to middle C.
  2. Raise VCO 2 1 into VCO 3 for vibrato.
  3. Adjust VCO 2 frequency for vibrato speed.

Violin



B.



VCO TUNING

VCO 1+3

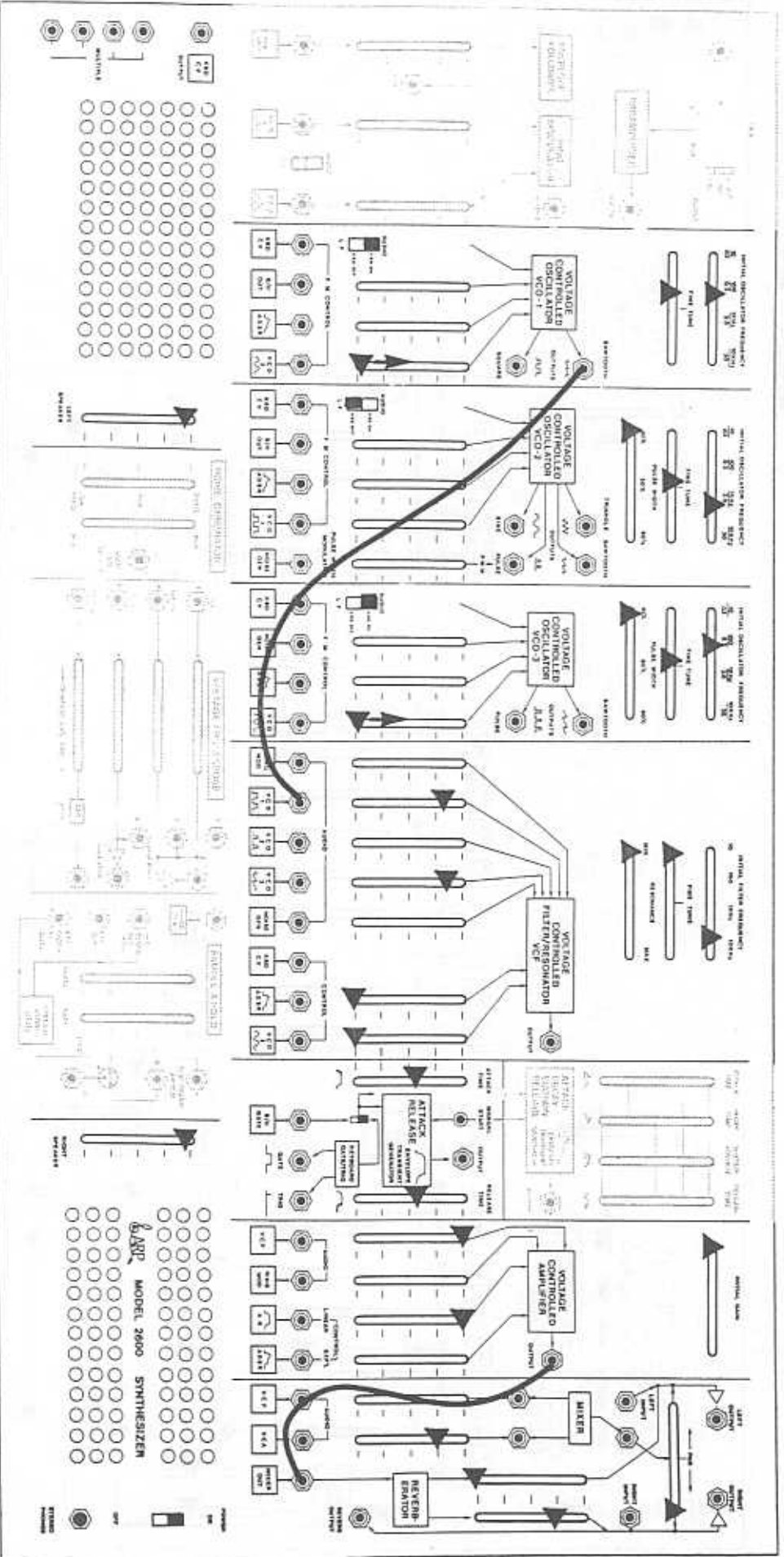

1. Tune VCO 3 to middle C.
2. Tune VCO 1 several beats off VCO 3.
3. Raise VCO 2 into VCO 1+3 for vibrato.
4. Adjust VCO 2 frequency for vibrato speed.

2 PATCHCORDS

ARP MODEL 2000 SYNTHESIZER

String Sweetener

6.



VCO 2

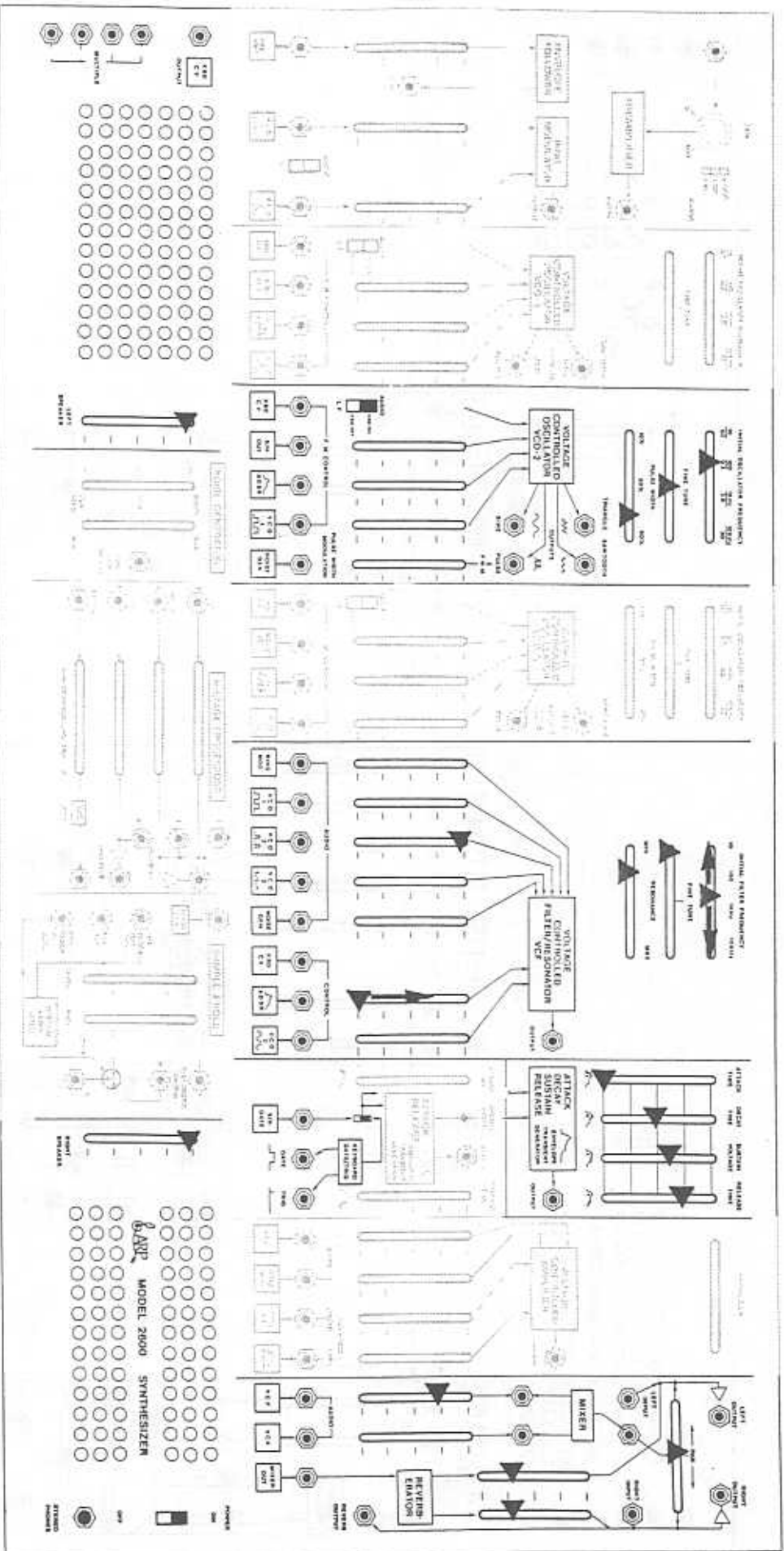

1. Open VCF — and tune VCO 2 to 1octave below middle C.
2. Close VCF — and raise ADSR | into VCF for brightness.

Octabass

4.



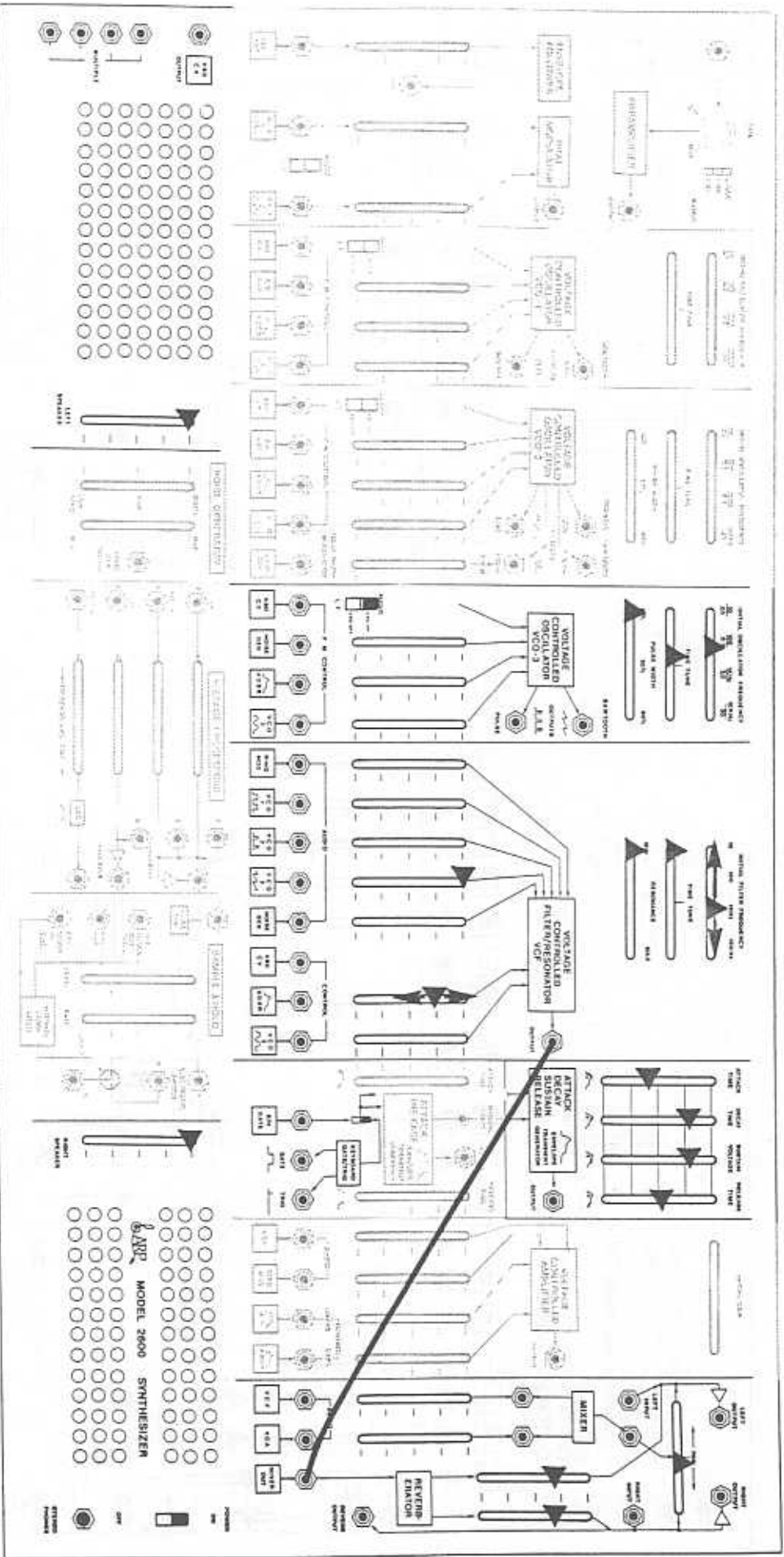
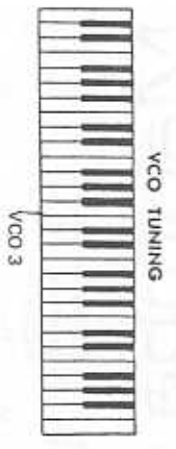

1. Open VCF — and tune VCO 3 to middle C.
2. Close VCF — and adjust ADSR slider | into VCF for trumpet or French horn.

1 PATCHCORD

# Trumpet & French Horn

# 2.

