

CASIO HT-700

ELECTRONIC MUSICAL INSTRUMENT
INSTRUMENTO MUSICAL ELECTRONICO

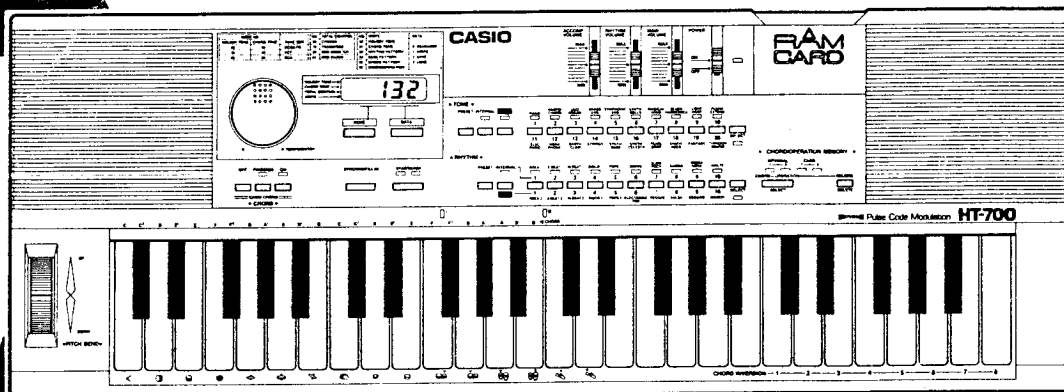

OPERATION
MANUAL 5
MANUAL DE
OPERACION 51

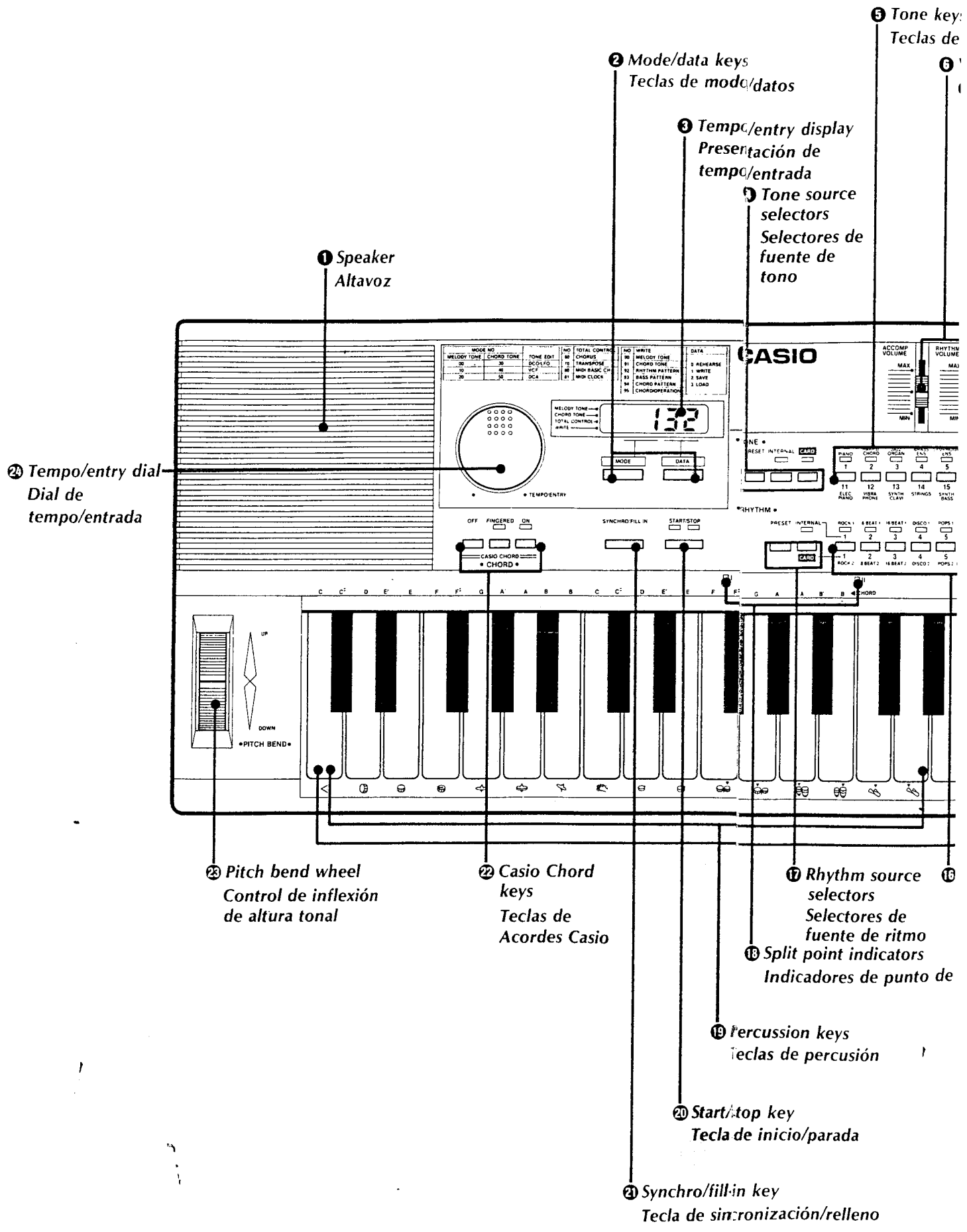

⑥ Tempo/entry dial
Dial de tempo/entrada

⑦ Pitch bend wheel
Control de inflexión de altura tonal

⑧ Casio Chord keys
Teclas de Acordes Casio

⑨ Rhythm source selectors
Selectores de fuente de ritmo

⑩ Split point indicators
Indicadores de punto de

⑪ Percussion keys
Teclas de percusión

⑫ Start/top key
Tecla de inicio/parada

⑬ Synchro/fill-in key
Tecla de sincronización/relleno

② Mode/data keys
Teclas de modo/datos

③ Tempo/entry display
Presentación de tempo/entrada

④ Tone source selectors
Selectores de fuente de tono

① Speaker
Altavoz

⑤ Tone key
Teclas de

⑥

- 5 Tone keys
Teclas de tono
- 6 Volume sliders
Cursores de volumen
- 7 Power switch
Interruptor de alimentación
- 8 Power indicator
Indicador de alimentación
- 9 Tone bank selector
Selector de banco de tonos
- 10 RAM card slot
Ranura de tarjeta RAM
- 11 Speaker
Altavoz

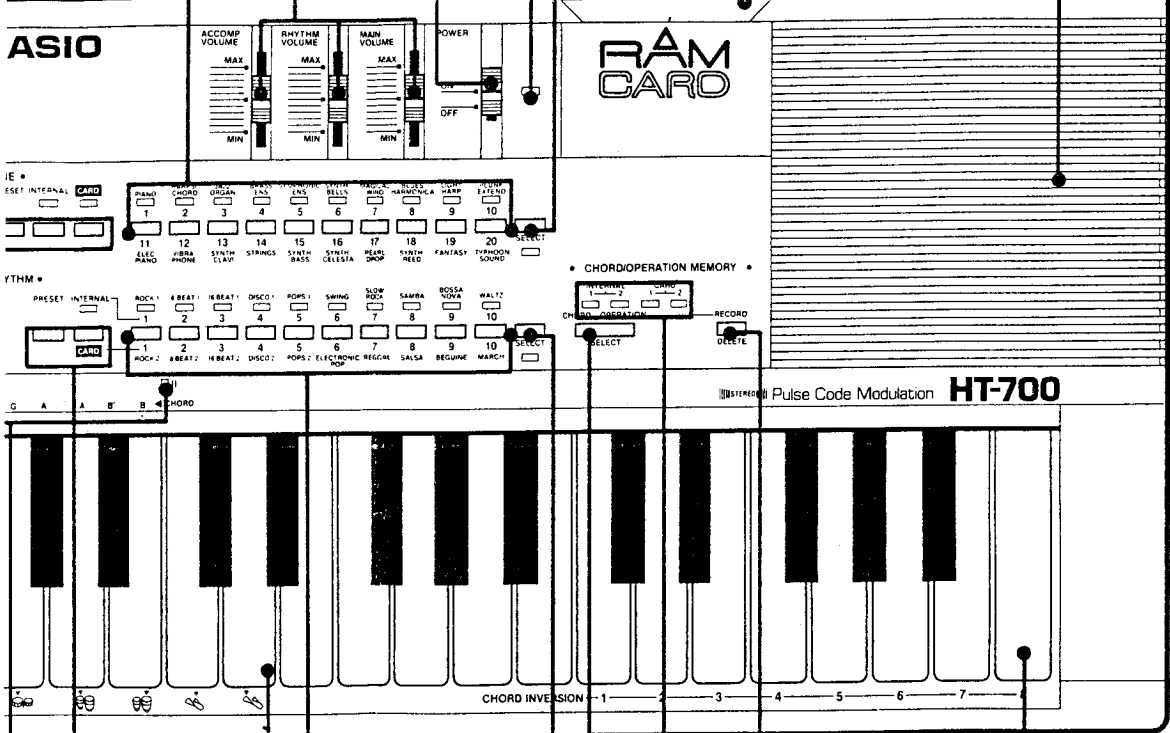

- 12 Record/delete key
Tecla de registro/borrado
- 13 Chord/operation memory indicators
Indicadores de memoria de acordes/operación
- 14 Chord/operation select key
Tecla de selección de acordes/operación
- 15 Rhythm bank selector
Selector de banco de ritmos
- 16 Rhythm keys
Teclas de ritmo
- 17 Rhythm source selectors
Selectores de fuente de ritmo
- 18 Split point indicators
Indicadores de punto de división
- 19 Percussion keys
Teclas de percusión
- 20 Stop key
Tecla de inicio/parada
- 21 Fill key
Tecla de organización/relleno

C
PR
IN
The dig
fun
spli
in r
ster
reli
san

CASIO HT-700

PROGRAMMABLE DIGITAL SYNTHESIZER

INTRODUCTION

Thank you and congratulations on your purchase of the Casio HT-700 digital synthesizer. Your new keyboard features exciting features and functions such as tone editing and writing, pattern memory, keyboard split, chord memory and great digital sounds. What's more, it has built-in monitor speakers, so there's no need to connect it to an amplifier or stereo! To obtain optimum performance and assure long-term reliability, be sure to read this manual carefully before using this sampling keyboard.

Contents

1. Main Features of the HT-700	6
2. Features & Functions	7
3. Basic Connections	9
4. Power Supply	10
5. Basic Operations	12
6. Keyboard Tones	14
7. Auto-rhythm Function	16
8. Casio Chord Function	18
9. Sound Synthesis	21
10. Editing & Writing Tones	25
11. Chord/Operation Memory	31
12. Pattern Memory	33
13. Save/Load Operations	39
14. Key Transpose	40
15. MIDI	41
16. RAM Card	45
17. Troubleshooting	46
18. Care of Your Keyboard	47
19. Specifications	48

1 Main Features of the HT-700

1. Tone editing & writing

Although the HT-700 is a digital keyboard, its built-in sounds are created in a system which is very similar in design to analog synthesizers, so that HT-700 tones can be freely edited or even written from scratch by altering various parameters which determine the characteristics of each individual sound. This allows you to edit preset sounds to your liking, or make your own original sounds.

2. MIDI compatibility

The HT-700 is MIDI-compatible, for connection with other MIDI synthesizers, sequencers and memory devices.

3. Chord/operation memory

The HT-700's chord/operation memory function allows you to create backing chord patterns for two different songs, each containing up to 640 chords, as well as 198 different "operations," including changes in tone, rhythm and fill-ins, for automatic accompaniment of your original songs.

4. Pattern memory

The pattern memory function allows programming of up to ten 2-bar patterns and ten 1-bar fill-ins, including bass, rhythm, and chords. Create your own accompaniment patterns and play along! In addition, you can change the basic rhythm of your original patterns by selecting any of the auto-rhythm tracks.

2 Features & Functions

Refer to the fold out connected to the first page of this manual for a detailed illustration of the HT-700.

- ① **Speakers**
Output sounds when phone plug and audio cable are not connected to jacks.
- ② **Mode/data keys**
Used to enter programming mode and data channels.
- ③ **Tempo/entry display**
Displays values specified via tempo/entry dial.
- ④ **Tone source selectors**
Used to specify tone mode—preset, internal or card.
- ⑤ **Tone keys**
Used to select timbre within specified tone source and tone bank.
- ⑥ **Volume sliders**
Used to control overall volume (main), accompaniment, and rhythm sound output via the built-in speakers or output jacks.
- ⑦ **Power switch**
- ⑧ **Power indicator**
- ⑨ **Tone bank selector**
Used to select tone bank (1—10) or (11—20) within specified tone source.
- ⑩ **RAM card slot**
Port used to connect optional RAM card (RA-100).
- ⑪ **Keyboard**
49 keys. Features 2 keyboard split points.
- ⑫ **Record/delete key**
Used to input/delete data to/from memory.
- ⑬ **Chord/operation memory indicators**
Indicate mode of chord/operation memory programming.
- ⑭ **Chord/operation select key**
Used to specify mode of chord/operation programming.
- ⑮ **Rhythm bank selector**
Used to select rhythm bank within specified rhythm source.
- ⑯ **Rhythm keys**
Used to select timbre within specified rhythm source and rhythm bank.
- ⑰ **Rhythm source selectors**
Used to specify rhythm source—preset, internal or card.
- ⑱ **Split point indicators**
Indicate the points where the keyboard split function divides the keyboard.
- ⑲ **Percussion keys**
Used to program percussion sounds in the pattern program rhythm track.
- ⑳ **Start/stop key**
Starts and stops auto-rhythms, pattern programs and chord memory programs.

2. Features & Functions

① Synchro/fill-in key

Used to specify synchronized starts of rhythm when keyboard is touched and to trigger programmed rhythm fills.

② Casio Chord keys

Used to specify the mode of the Casio Chord function.

③ Pitch bend wheel

Used to bend the pitch of notes, up or down.

④ Tempo/entry dial

Used to raise or lower tempo and also to specify mode and data parameters.

(R)

①

②

③

④

⑤

⑥

3 Basic Connections

(Rear panel)

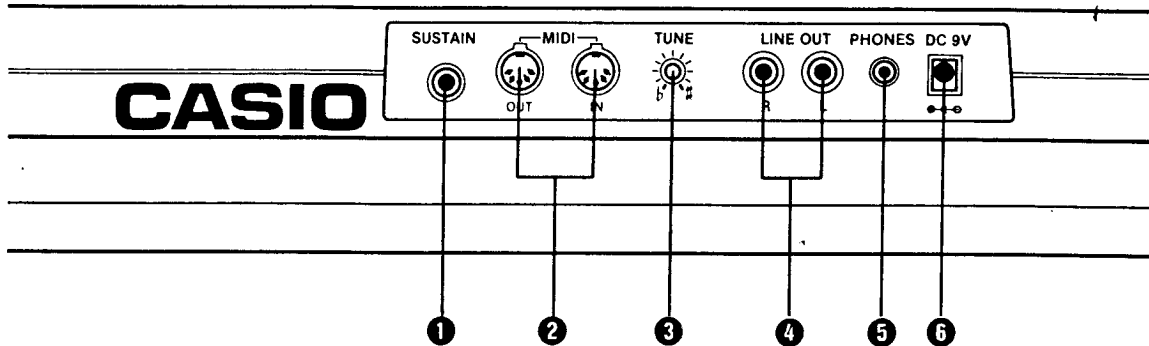

- 1 Sustain jack**
Used to connect external sustain pedal (SP-2, optional).
- 2 MIDI IN/OUT terminals**
Used to receive/transmit MIDI messages.
- 3 Tuning control**
Adjusts pitch of entire keyboard within ± 50 cents.
- 4 Output jacks (R/L)**
For connection to external keyboard amplifier or audio equipment.
- 5 Headphone jack**
For connection of headphones (CP-2, optional).
- 6 AC adaptor jack**
For connection of AC adaptor (AD-5/CA-5, optional).

4 Power Supply

⌋ This unit operates on both AC and DC power.

DC power

• Dry batteries

This unit can be powered by six D size (SUM-1) manganese dry batteries. Weakened batteries will result in lower volume or poor tonal quality. The power indicator lamp will gradually lose its brightness when battery power weakens. At this time, change batteries or shift to one of the alternate power sources mentioned below.

Battery replacement:

- ① Open the battery compartment cover on the bottom of the unit and take out used batteries.
- ② Load new batteries taking care that polarity is correct.
 - * It is advisable to replace all six batteries at the same time for longer battery life.
 - * Refer to the specifications for standard battery life.

• Car battery

With the car battery adaptor (CA-5, optional), DC power is supplied from a car battery through the cigarette lighter socket.

AC power

An AC adaptor (AD-5, optional) is required to connect to an AC outlet. Use only an adaptor with the same voltage rating (100, 117, 220, or 240V) as the power supply in your area to prevent component damage. Plug the AC adaptor into the AC outlet and the cord into the unit. This will automatically cut off the battery power supply.

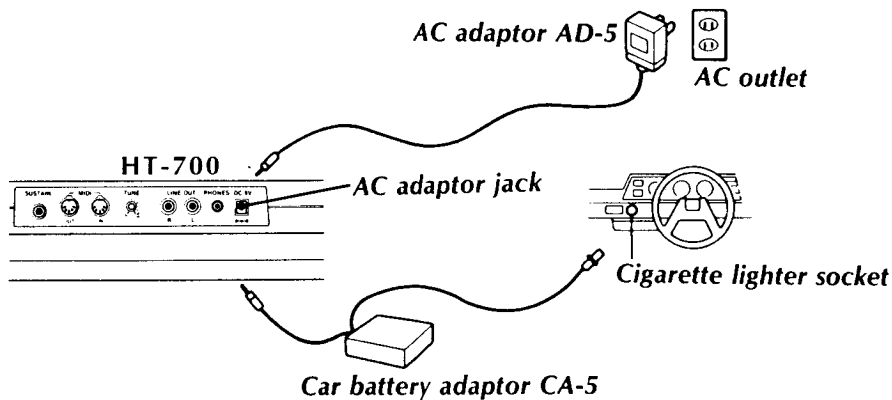

★ Auto power off function

Power is automatically cut off approximately 6 minutes after the last operation of the unit. Power supply can be restored by switching power OFF and then ON again.

CAUTION

- * Use only genuine CASIO adaptors to avoid risk of damage.
- * Remove batteries from the battery compartment when the unit is not used for extended periods. (Battery leakage can damage electrical parts.)
- * The adaptor may become warm when left connected to an outlet. This is normal, but the adaptor should be disconnected when not in use.
- * THE FOLLOWING CONDITIONS CAN CAUSE BATTERIES TO BURST:
 1. Use of adaptors other than genuine CASIO adaptors.
 2. Loading batteries with polarities reversed.

5 Basic Operations

[How to make music on the HT-700]

① Turn the power ON.

- After selecting the power source you intend to use and making necessary connections, switch power ON.
- The power indicator will light. Immediately after the power is turned ON, the "PIANO" tone (timbre) and "ROCK 1" rhythm are automatically selected.

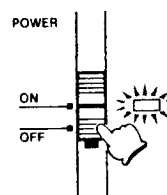

② Adjust the volume.

- Using the main volume slider, adjust the main volume to an appropriate level.

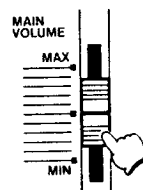

Now, go ahead and get a feel for the HT-700 keyboard. Notice that in this initialized mode, the PIANO tone sounds on all keys of the keyboard.

[INIT

To ini

① Tur

② Ho

[PITC

The

• Th

the

on

"F

[INITIALIZATION]

To initialize data (return all operations to factory preset state):

① Turn power OFF.

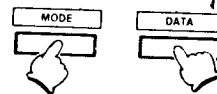

② Hold down mode key and data key, and turn power ON.

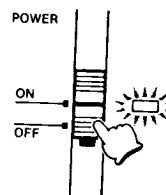

[PITCH BENDER]

The HT-700 features a pitch bender which is fixed at a bend range of 2 whole notes.

- The bender is in effect throughout the entire keyboard when the Casio Chord function is set to "OFF". It corresponds only to upper tone keys when this function is set to "FINGERED" or "CASIO CHORD ON".

Pitch bend wheel

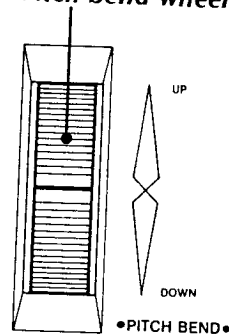

6 Keyboard Tones

The HT-700 is equipped with 20 factory preset tones, plus 20 internal tones. An additional 20 tones can be utilized through the use of an optional RAM card (RA-100). The tones can be selected by pressing any of the tone keys after specifying a tone source and tone bank within the tone source.

*When power is turned ON, "PIANO" is automatically selected.

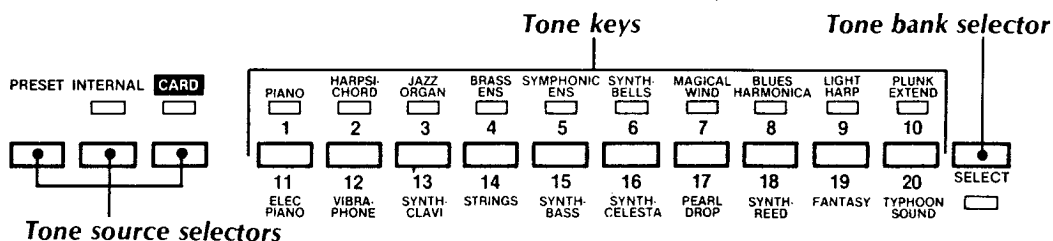

■ SELECTING A KEYBOARD TONE ■

① Specify the tone source to be used by pressing a tone source selector ("PRESET" or "INTERNAL" if RAM card is not in use).

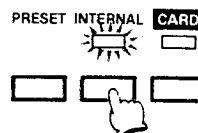

- The upper tone bank (tones 1 through 10) is selected when the tone bank "SELECT" key is off. To specify the lower bank press the key so that the LED lights.

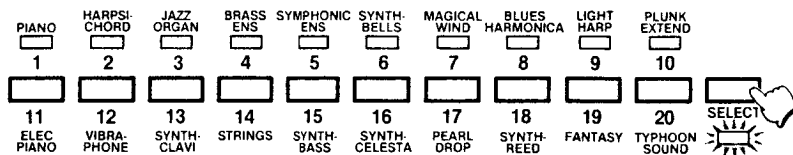

② Press the tone key corresponding to the desired tone.

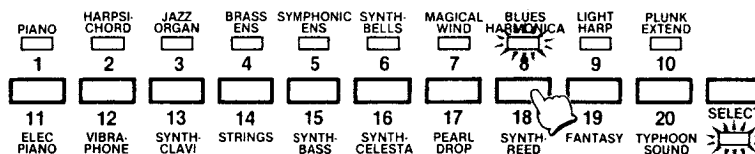

■ INTERNAL TONES ■

Tones listed on the display panel correspond to the "PRESET" sound source. Internal tones are listed below:

Tone Number	Tone Timbre
1	Piano 2
2	Marimba
3	Pipe Organ
4	Strings 2
5	Synth-Ens 1
6	Synth-Vib 1
7	Koto
8	Double Reed
9	Clarinet
10	Miracle

Tone Number	Tone Timbre
11	Elec Piano 2
12	Vibraphone 2
13	Violin
14	Synth-Strings
15	Synth-Ens 2
16	Synth-Vib 2
17	Synth-Harp
18	Slash Reed
19	Synth-Guitar
20	Explosion

*Edited tone can be written to INTERNAL TONE memory area. Factory preset data (INTERNAL TONE) may be returned, when initialization is done. (Initialization → P. 13)

NOTES

- An additional timbres can be selected by utilizing an optional RAM card (RA-100).
- The "CARD" tone source selector does not function unless a card is in use.
- The above procedures may be performed in any order. Source, bank and tone can be altered freely at any time in this mode.

1 Auto-rhythm Function

The HT-700's auto-rhythm function features a total of 20 PRESET rhythms, 10 INTERNAL rhythms and corresponding fill-in patterns. 10 additional rhythms can be utilized through the use of an optional RAM card (RA-100). Basic rhythms can be selected by pressing any of the rhythm keys, after specifying the rhythm source and rhythm bank.

*When power is turned ON, "ROCK 1"—a PRESET rhythm—is automatically selected.

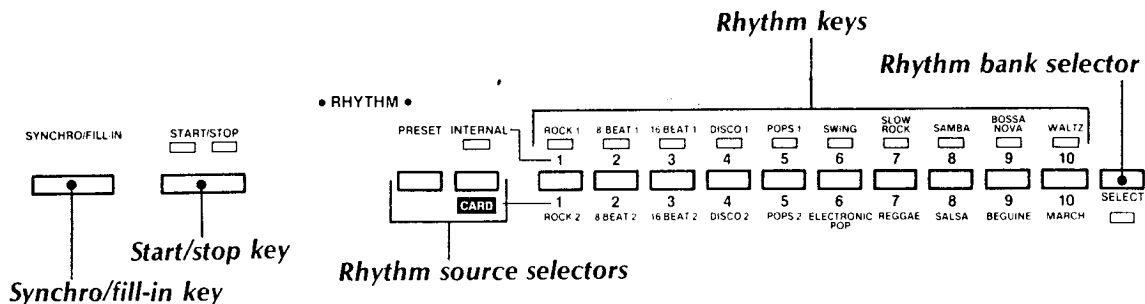

■ SELECTING A RHYTHM TRACK ■

① Specify the rhythm source by pressing a rhythm source selector ("PRESET" or "INTERNAL/CARD").

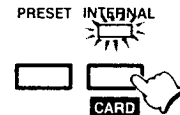

• When the preset source is selected, either the upper or lower bank may be selected. Press the rhythm bank selector to specify the lower bank ("ROCK 2" ~ "MARCH").

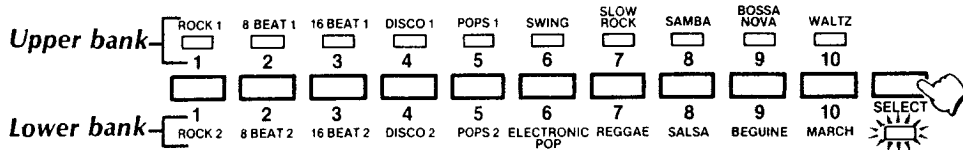

• When the INTERNAL/CARD source is selected, the upper bank is used to select internal rhythms, while the lower bank is used to select RAM card rhythms. To utilize RAM card rhythms, press the rhythm bank selector so that the corresponding LED lights.

NOTE: The above procedures may be performed in any order. Source, bank and rhythm can be altered freely at any time in this mode.

[How to start an auto-rhythm track]

① After selecting the desired type of rhythm via the procedures described above, press the start/stop key.

② The rhythm track starts, and the tempo indicator lights, with a red LED marking the first beat of each measure. Remaining beats in each measure are indicated by a yellow LED.

• Adjust rhythm volume
Adjust the rhythm volume to an appropriate relative level using the rhythm volume slider.

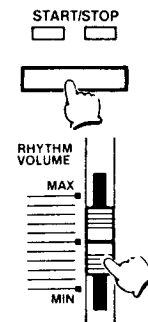

<ALTERING TEMPO>

In the performance mode (as opposed to programming), the liquid crystal display shows the tempo of the rhythm track. To alter the tempo, simply turn the tempo/entry dial—right to increase tempo, and left to decrease it.

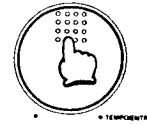

■ SYNCHRO START ■

This function allows you to start the rhythm track in synchronization with the first note played on the keyboard (below the split point I).

① After selecting the desired rhythm, press the synchro/fill-in key.

• The yellow tempo indicator flashes on beat, indicating that the synchro start function is in a standby mode.

② The rhythm track will start as soon as you play a lower tone key on the keyboard (any key below the split point I).

SYNCHRO/FILL-IN

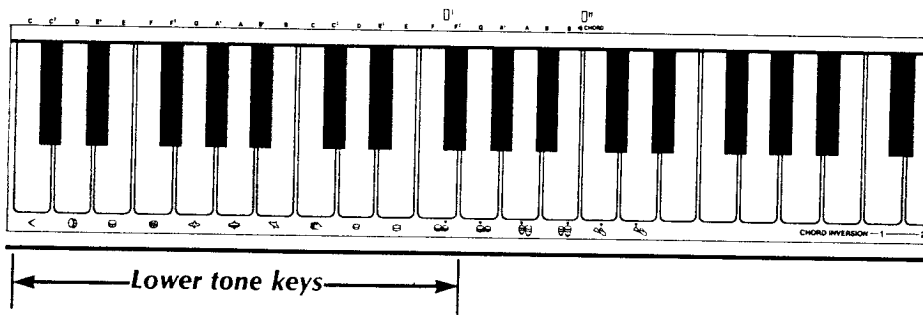

■ INSERTING RHYTHM FILL-INS ■

The HT-700 features fill-in patterns, corresponding to the auto-rhythm tracks.

Pressing the synchro/fill-in key while a rhythm track is playing inserts a fill-in pattern into the normal rhythm. If the key is held down, the fill-in pattern is repeated until the end of the measure during which the key is released.

SYNCHRO/FILL-IN



■ STOPPING AN AUTO-RHYTHM TRACK ■

Auto-rhythm tracks can be stopped at any point by simply pressing the start/stop key once again.

START/STOP



8 Casio Chord Function

 The HT-700 is equipped with Casio's unique Casio Chord function. This lets you add full-chord accompaniment to your melodies in either One-Finger, or Fingered modes, depending on your skill and preference.

[How to use the Casio Chord function]

■ ONE-FINGER ACCOMPANIMENT (Casio Chord) ■

This Auto-accompaniment function lets you automatically play full chords with just one finger, and adds an appropriate bass line corresponding to the rhythm style and chords played.

- ① Press the Casio Chord "ON" button,
 - A corresponding red LED will light.

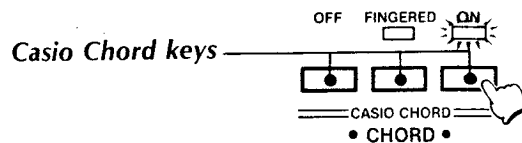

- ② Start the selected rhythm track in the auto-rhythm section. (Use synchro start if you desire.)

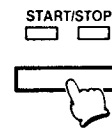

- ③ When a any of the keys below the split point are played, a corresponding chord is sounded.
- ④ Stop the rhythm track by pressing start/stop key.

- Adjust the level of the accompaniment sound with the accomp. volume slider.

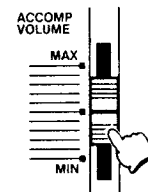

- Adjust the tempo of the rhythm with the tempo/entry dial.

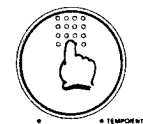

NOTE
Casio

C

In
c
<
V
n
p
p
th
k
p

z

C
C
C
C

A
S
E

■ F1
Finger
and
chord

① Pr

NOTE: The keyboard split function comes in effect automatically whenever the Casio Chord function is selected.

Casio Chord Patterns

In addition to major chords, the Casio Chord function produces various other chords as shown below:

<Relationship between keys played and type of chord>

When the Casio Chord function is ON, major chords are produced which have the note pressed as a root. They are automatically played in time with the rhythm pattern, together with an appropriate bass line. In order to change the auto-accompaniment to a minor chord, simply press any other key on the lower tone section of the keyboard to the right of the root key, together with the root. Pressing one more key (for a total of three) under these conditions produces seventh chords, while pressing a fourth key produces minor seventh chords.

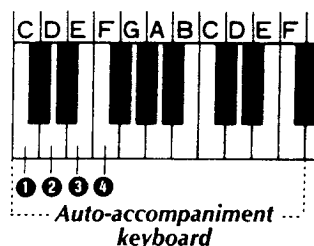

<Examples>

- C (C major) Press ①.
- Cm (C minor) Press ① & ② together.
- C₇ (C seventh) Press ①, ② & ③ together.
- Cm₇ (C minor seventh) ... Press ①, ②, ③ & ④ together.

NOTE: Not only ②, ③ and ④, but any keys to the right of ① on the Lower Tone section of the keyboard will produce the same effect, regardless of whether they are black or white keys.

■ FINGERED ACCOMPANIMENT ■

Fingered accompaniment lets you create chords yourself, by playing corresponding keys, and adds an appropriate bass line in correspondence with the rhythm style and type of chords played.

- ① Press the Casio Chord FINGERED button.

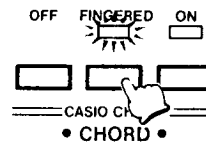

8. Casio Chord Function

② Start the selected rhythm track in the auto-rhythm section.
(Use synchro start if you desire.)

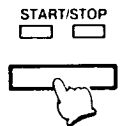

SYNCHRO/FILL-IN



③ The keyboard responds to chords played by inserting them in the accompaniment pattern, together with an appropriate bass line.

- Adjust the level of the accompaniment sound with the accomp. volume slider.

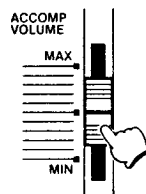

- Adjust the tempo of the rhythm with the tempo/entry dial.

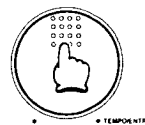

④ Stop the rhythm by start/stop key. (Use ending key if you desire.)

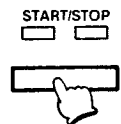

■ CHANGING KEYBOARD SPLIT POINT ■

The HT-700 features 2 different keyboard split points, which are indicated by red LEDs. The split point can be altered by pressing the "FINGERED" or "ON" key after the corresponding Casio Chord LED is already lit.

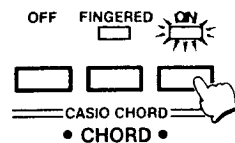

9 Sound Synthesis

HT-700 tones are comprised of a variety of "parameters". These parameters control the characteristics of each individual sound, including such elements as timbre, pitch and volume. To edit or synthesize new sounds, the values of these parameters are altered or set to desired levels.

A list of these parameters and the range of values which may be set for them is shown in the parameter index as shown below.

■ SOUND SYNTHESIS TECHNIQUES ■

To create sounds on the HT-700, you simply change, or "edit" preset timbre programs. The term "program" here refers to the values of all parameters which make up a single tone. Practically speaking, a program may be thought of simply as a tone.

It is not necessary to start with a "blank slate" when creating a new program. The easiest approach is to first select a tone that resembles the one you have in mind, and edit this sound until you get the sound you want. The list below contains descriptions of each parameter stored in memory, and how they effect the sound. Use this as a guide to editing sounds.

■ PARAMETERS STORED IN MEMORY ■

This section describes the various parameters which affect the characteristics of sounds created on the HT-700.

<PARAMETER INDEX>

		Mode No.	Mode Name	Data	Note
MELODY TONE EDIT	DCO/LFO	00	DCO WAVEFORM	0-31	The choice of waveforms will have more effect on the tonal characteristics (timbre) of the sound than will any other parameters. Practically speaking, DCO waveforms determine the basic instrument "family" which the sound corresponds to.
		01	LFO DEPTH	0-31	Determines the depth of LFO modulation. This modulation is used in creating vibrato effects.
		02	LFO WAVEFORM	0 ^, 1 ~, 2 ^, 3 ~, 4 RANDOM	Used to select the basic waveform which is used to modulate the LFO.
		03	LFO DELAY	0-31	Determines the amount of delay following key depression prior to the onset of vibrato or other modulation effects.
		04	LFO SPEED	0-31	Controls the frequency at which the LFO operates, determining the speed of cyclic pitch or tonal variation.
	VCF	10	CUTOFF FREQUENCY	0-31	Determines the cutoff frequency of the low-pass filter. The higher the cutoff frequency, the less effect the filters have on the basic waveforms (as more harmonics are passed). At the highest value, all harmonics are passed. As the value becomes lower, more harmonics are cut off so that the sound becomes progressively "rounder," or less bright.
		11	RESONANCE	0-7	Emphasizes harmonics near the cutoff frequency, producing a peaky or bandpass type of sound. The higher the value, the higher the resonance peak and the more obvious the effect. At or near maximum, the VCFs go into self-oscillation, producing a pure sine wave, which may be used as an additional sound source for special effects.
		12	ATTACK	0-31	Determines how long it takes for the VCF output voltage to rise from zero to its maximum level. Essentially, attack determines the "quickness" at which a sound's contour (changes in characteristics over time) changes after a note is played on the keyboard.

9. Sound Synthesis

		Mode No.	Mode Name	Data	Note
MELODY TONE EDIT	VCF	13	DECAY	0 ~ 31	Determines the period that it takes for the output voltage to fall from the maximum contour level to the SUSTAIN level.
		14	SUSTAIN	0 ~ 31	The voltage to which the contour decays, assuming that the note is still being played on the keyboard.
		15	RELEASE	0 ~ 31	Release time is the period that it takes for the contour to fall away from the release level to the initial voltage level after the note has been released.
		16	ENV. DEPTH	0 ~ 31	Determines the amount of effect that the VCF has on the overall sound.
	DCA	20	ATTACK	0 ~ 31	Determines how long it takes for the DCA output voltage to rise from zero to its maximum level. Essentially, attack determines the "quickness" at which a sound reaches its maximum volume after a note is played on the keyboard.
		21	DECAY	0 ~ 31	Determines the period that it takes for the output voltage to fall from the maximum contour level to the SUSTAIN level.
		22	SUSTAIN	0 ~ 31	The voltage to which the contour decays, assuming that the note is still being played on the keyboard.
		23	RELEASE	0 ~ 31	Release time is the period that it takes for the contour to fall away from the release level to the initial voltage level after the note has been released.
		24	ENV. DEPTH	0 ~ 31	Determines the amount of effect that the VCF has on the overall sound.
		30	DCO WAVEFORM	0 ~ 15	The choice of waveforms will have more effect on the tonal characteristics (timbre) of the sound than will any other parameters. Practically speaking, DCO waveforms determine the basic instrument "family" which the sound corresponds to.
CHORD TONE EDIT	DCO	31	VIBRATO	0, OFF 1, ON 2, DELAY	
		VCF	40	CUTOFF FREQ.	0 ~ 31
	41		RESONANCE	0 ~ 7	Emphasizes harmonics near the cutoff frequency, producing a peaky or bandpass type of sound. The higher the value, the higher the resonance peak and the more obvious the effect. At or near maximum, the VCFs go into self-oscillation, producing a pure sine wave, which may be used as an additional sound source for special effects.
	42		ATTACK	0 ~ 31	Determines how long it takes for the VCF output voltage to rise from zero to its maximum level. Essentially, attack determines the "quickness" at which a sound's contour (changes in characteristics over time) changes after a note is played on the keyboard.
	43		DECAY	0 ~ 31	Determines the period that it takes for the output voltage to fall from the maximum contour level to the SUSTAIN level.
	44		SUSTAIN	0 ~ 31	The voltage to which the contour decays, assuming that the note is still being played on the keyboard.
	45		RELEASE	0 ~ 31	Release time is the period that it takes for the contour to fall away from the release level to the initial voltage level after the note has been released.
	46		ENV. DEPTH	0 ~ 31	Determines the amount of effect that the VCF has on the overall sound.
	DCA		50	ATTACK	0 ~ 31

		Mode No.	Mode Name	Data	Note
CHORD TONE EDIT	DCA	51	DECAY	0 - 31	Determines the period that it takes for the output voltage to fall from the maximum contour level to the SUSTAIN level.
		52	SUSTAIN	0 - 31	The voltage to which the contour decays, assuming that the note is still being played on the keyboard.
		53	RELEASE	0 - 31	Release time is the period that it takes for the contour to fall away from the release level to the initial voltage level after the note has been released.
		54	ENV. DEPTH	0 - 31	Determines the amount of effect that the VCF has on the overall sound.
TOTAL CONTROL	CHORUS	60	CHORUS	0 OFF, 1, 2, 3	Determines level of chorus effect.
	TRANPOSE	70	TRANPOSE	-5 - 0 - 6	Transposes key (pitch of notes).
	MIDI	80	BASIC CH	1 - 13	Used to select Basic Channel and Clock Mode for MIDI communications.
		81	CLOCK	0 INT., 1 EXT.	
WRITE	TONE	90	UPPER	1 WRITE, 2 SAVE, 3 LOAD	Used to perform programming operations in WRITE mode.
		91	LOWER	1 WRITE, 2 SAVE, 3 LOAD	
	PATTERN	92	RHYTHM	0, REHEARSE 1, WRITE, 2 SAVE, 3 LOAD	
		93	BASS	0, REHEARSE 1, WRITE, 2 SAVE, 3 LOAD	
		94	CHORD	0, REHEARSE 1, WRITE, 2 SAVE, 3 LOAD	
	CHORD/OPERATION	95	SAVE/LOAD	2, SAVE, 3 LOAD	

<WAVE FORM (UPPER)>

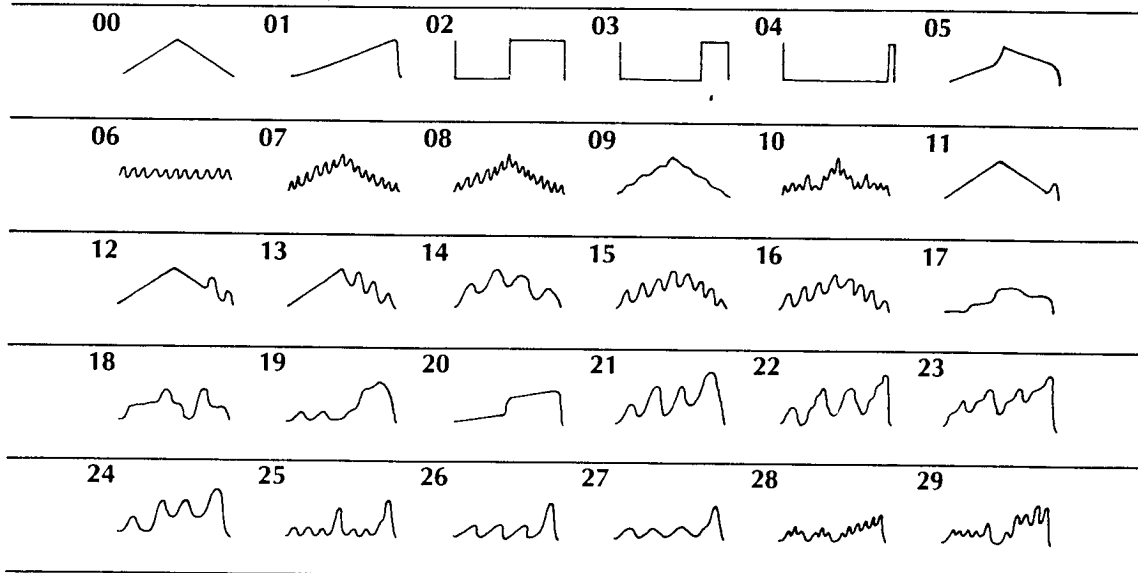

9. Sound Synthesis

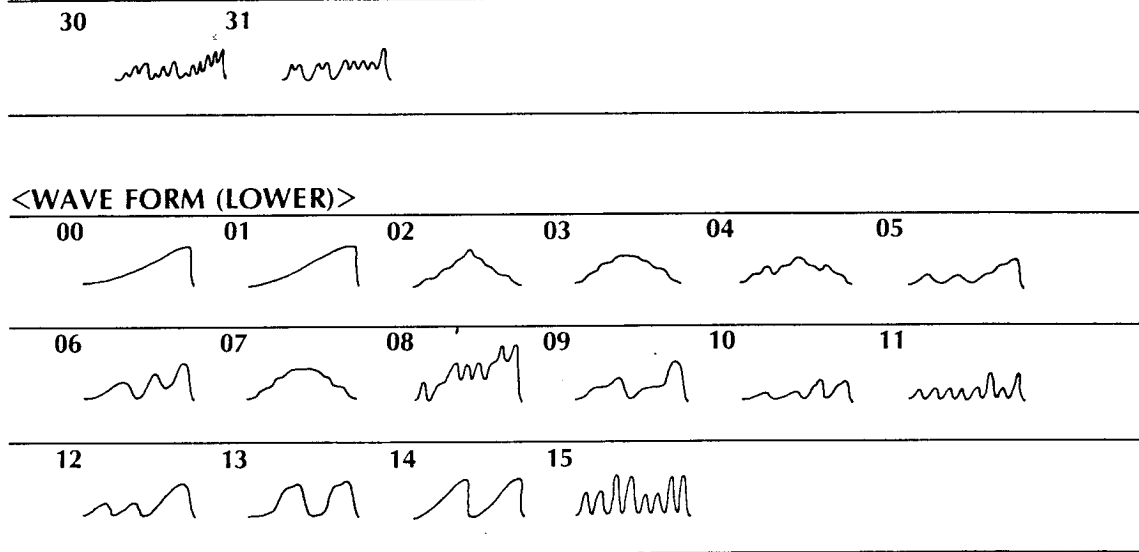

■ EDITING VALUES ■

Features & functions for control

- **Mode key**

Used to specify editing mode.

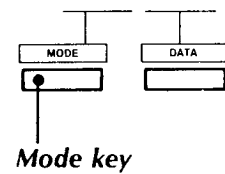

- **Tempo/entry dial**

Used to select parameter and value (data).

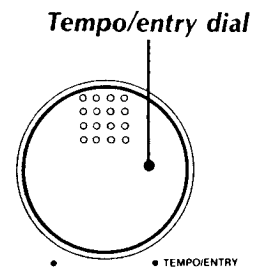

- **Data key**

Used to specify editing of value for selected parameter.

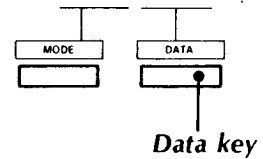

- **Tempo/entry display**

Displays selected parameter number (mode) and value (data).

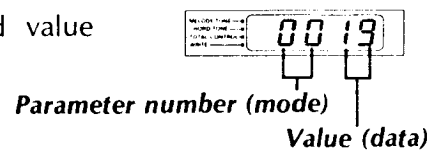

10 Editing & Writing Tones

 The following procedures describe how to edit tones by altering the values of their parameters, and write them to memory.

■ EDITING TONES ■

① Select the tone to be edited.

② Press the mode key.

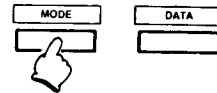

③ Turn the tempo/entry dial to select the number of the parameter to be edited. (Refer to parameter index.)

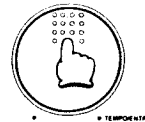

④ Press the data key.

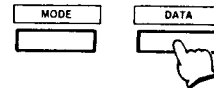

- Value display (right side of LCD) varies according to the parameter which is to be edited. This is because the range in which parameters can be edited varies.
- Refer to the parameter index for information on specific range of each parameter.

NOTE: In place of values, some parameters are controlled by toggles (switches), turning them ON or OFF, or selecting specific effects.

⑤ Turn the tempo/entry dial to select the desired value for the selected parameter.

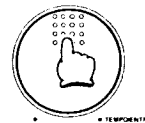

- Note that the LED corresponding to the tone number selected flashes in this mode. This indicates that the edited tone may be "compared" to the initialized tone. Press the tone key and the LED remains lit (does not flash). In this state, the initialized Tone sounds on the keyboard, press it again and the LED begins flashing, indicating that the edited tone is specified.

⑥ When you are satisfied with the edited tone, press the mode key to exit from the programming mode. You may then edit another parameter by repeating steps (3) through (5).

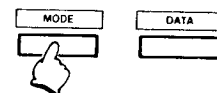

⑦ When you are finished editing desired parameters, press the mode key twice to exit to the tempo mode.

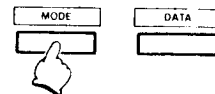

10. Editing & Writing Tones

<EXAMPLE>

The following is a working example of how to edit an HT-700 parameter.

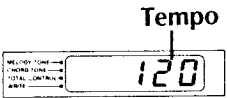
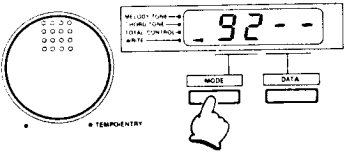
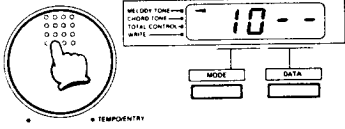
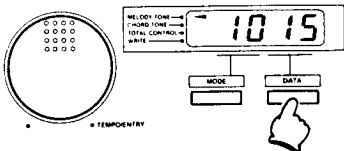
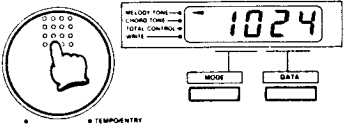
Operation	Notes	Display
Alter the cutoff frequency of the melody tone to a value of "24."	Initially, the display is in the TEMPO mode. (Select the "PIANO" of preset tone.)	
① Press the mode key.		<p>Previously selected mode displayed.</p> 
② Turn the tempo/entry dial so that the left side of the display shows "10."	Note that "10" corresponds to the cutoff frequency parameter for the melody tone.	
③ Press the data key.	Enters value editing mode. LED corresponding to selected tone ("PIANO") flashes.	<p>Previously selected value displayed.</p> 
④ Turn the tempo/entry dial so that a value of "24" is shown on the right side of the display.	Preset tone may be changed.* * Preset tone can be recalled by pressing the Tone key. When the LED does not flash, preset tone sounds. Press the Tone key again, edited tone sounds. (LED flash.)	

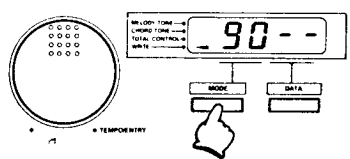
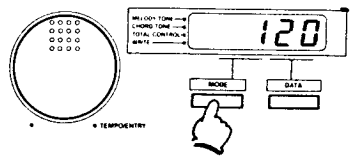
Operation	Notes	Display
⑤ Press the mode key.	Exits from value Editing mode. * Turn the dial to select the mode "90" for writing tone. (refer to WRITING TONES)	
⑥ Press the mode key once again.	Returns to tempo mode.	

■ WRITING TONES ■

Melody and chord tones edited via the edit procedures may be written to internal or RAM-card memory via the following procedures.

① Press the mode key.

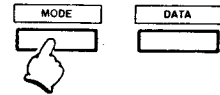

② Turn the tempo/entry dial to select the number of the tone to be written (either 90 or 91, corresponding to melody tone and chord tone, respectively).

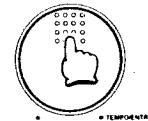

③ Press the data key.

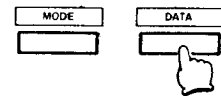

④ Turn the tempo/entry dial to select write mode within the selected tone (DATA 1). ("INTERNAL" (tone source) is automatically selected, when the data key is pressed.)

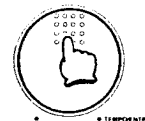

NOTE: Press the card key, to specify that tone is to be written to RAM card.

⑤ Press the tone key corresponding to the tone into which the edited sound is to be written.

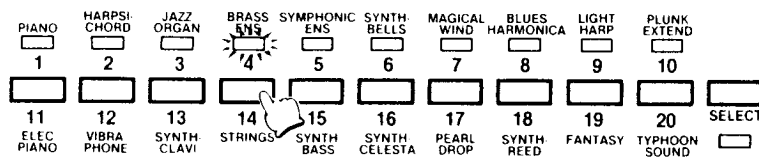

10. Editing & Writing Tones

<EXAMPLE>

The following is a working example of how to write the tone edited in the edit example to INTERNAL memory or RAM card memory.

<EXAMPLE 1: WRITING TO INTERNAL MEMORY>

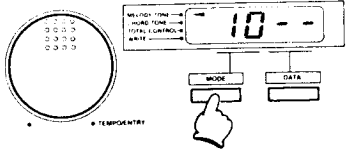
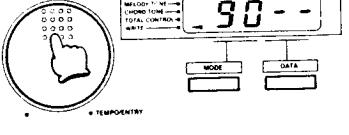
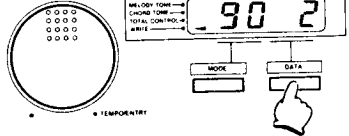
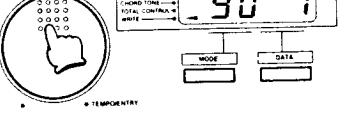
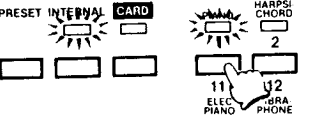
Operation	Notes	Display
① Press the mode key after editing a tone.	This operation continues from No. ⑤ in edit procedure on P. 27.	
② Turn the tempo/entry dial so that the left side of the display shows "90."	Note that "90" corresponds to the melody tone write parameter values.	
③ Press the data key.	Enters melody WRITE mode. Tone and rhythm LEDs go out and "INTERNAL" (tone source) is selected automatically.	
④ Turn the tempo/entry dial so that a value of "1" is shown on the right side of the display.	Note that "1" corresponds to WRITE mode within.	
⑤ Press the tone key which is desired to memory.	Tone is written to memory.	

<EXAMPLE 2: WRITING TO RAM CARD>

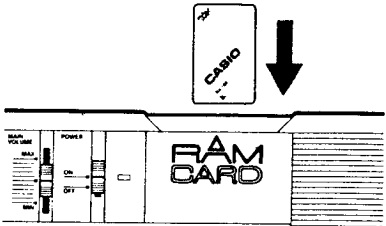
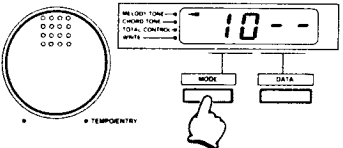
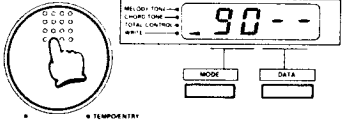
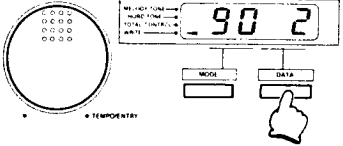
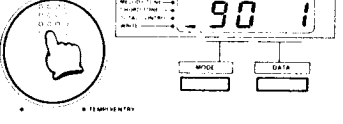
Operation	Notes	Display
<p>Write the tone edited in the EDIT example to RAM card memory (No. 11).</p>	<p>RAM card must be inserted in corresponding slot.</p>	
<p>① Press the mode key after editing a tone.</p>	<p>This operation continues from No. ⑤ in edit procedure on P. 27.</p>	
<p>② Turn the tempo/entry dial so that the left side of the display shows "90".</p>	<p>Note that "90" corresponds to the melody tone write parameter values.</p>	
<p>③ Press the data key.</p>	<p>Enters MELODY WRITE mode. Tone and rhythm LEDs go out and "INTERNAL" (tone source) is selected automatically.</p>	<p>Previously selected value displayed.</p> 
<p>④ Turn the tempo/entry dial so that a value of "1" is shown on the right side of the display.</p>	<p>Note that "1" corresponds to WRITE mode within.</p>	

10. Editing & Writing Tones

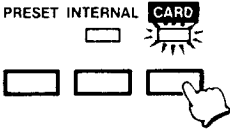
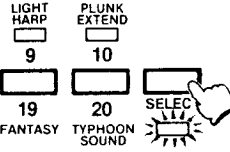
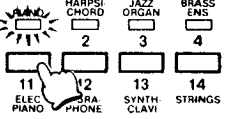
Operation	Notes	Display
⑤ Press the card key.	Specifies that edited data is to be written to RAM card memory.	Internal LED goes out, card LED lights. 
⑥ Press the bank select key.	Tone 11 is in the second tone bank, so the bank selector must be pressed.	
⑦ Press the tone key (No. 11) which is desired in memory.	Tone is written to memory.	Display returns to TEMPO mode, LEDs return to normal operating state. 

[F
T
m

Choro

■ C
① Se
(LE
Ye

② Pre
fla-

③ Sei
via

④ Pre
• In
fou
tim
pe

⑤ Pre
* C
se

⑥ Pre
mc

⑦ Pre
mc

11 Chord/Operation Memory

The chord/operation memory function holds a two complete songs (1 and 2), each containing up to 640 chords, and up to 198 operations. "Operations" refer to such things as changes in rhythm, tone, fill-ins. In addition, these songs may be written directly to a RAM card, or dumped onto a RAM card from the internal memory and recalled via save/load operations.

[How to program chord/operation memory]

The chord/operation memory is actually composed of two separate memories, a chord memory and an operation memory.

Chord/operation memory indicators

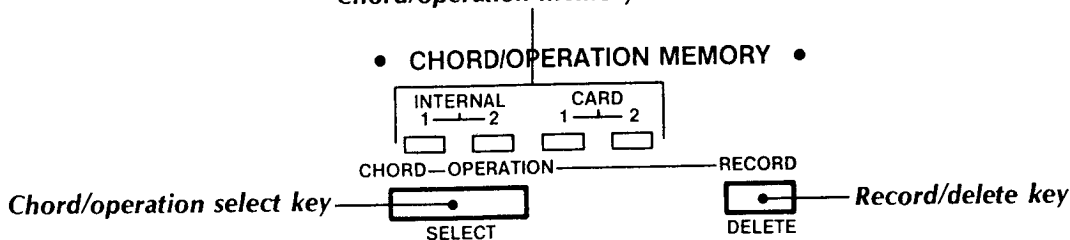

■ CHORD/OPERATION MEMORY PROGRAMMING ■

- ① Select the track to be programmed (1 or 2) via the select key. (LED lights: Red LED indicates "INTERNAL" memory. Yellow LED indicates "RAM card" memory.)
- ② Press the record key to enter the programming mode. (LED flashes.)
- ③ Select the memory to be programmed (chord or operation) via the select key. (Left LED: chord, Right LED: operation)
- ④ Press the start/stop key to begin rhythm track.
 - In this mode, programming has already begun. (After first four counts.) Program chord or operation memory via real-time operation, playing chords via Casio Chord, or performing desired operations.
- ⑤ Press the start/stop key to end programming.
 - * Continuous programming of chord or operation can be selected via the select key after pressing start/stop key.
- ⑥ Press the record key once again to exit from programming mode. (LED lights.)
- ⑦ Press the select key to exit from chord/operation memory mode. (LED goes out.)

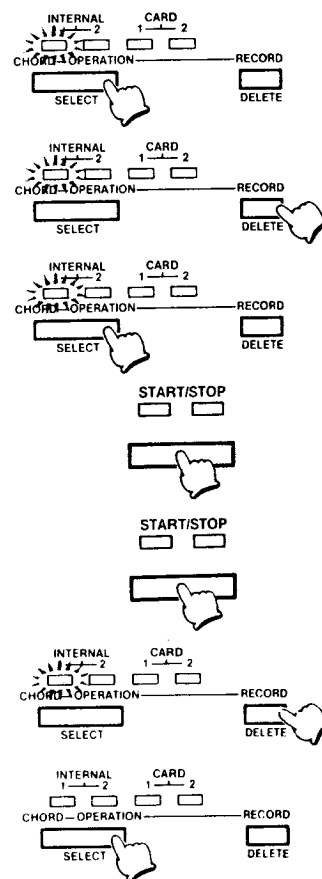

11. Chord/Operation Memory

[How to play back chord/operation memory]

① Select the track to be played back (1 or 2) via the select key. (LED lights.)

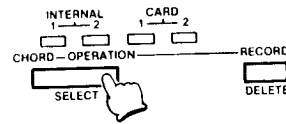

② Press the start/stop key to start the memory.

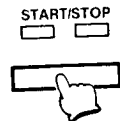

③ Press the select key to exit from chord/operation memory mode. (LED goes out.)

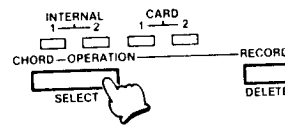

NOTES

- When programming chord memory, FINGERED or Casio Chord ON modes may be selected, along with either of the two keyboard split points. (After record key is pressed.)
- When programming operation memory, Casio Chord ON/OFF or FINGERED modes may be selected, along with either of the two keyboard split points. (After the record key is pressed.)
- Program stops at the point where operation memory is ended, taking precedence over chord memory.
- Memories should be cleared by pressing stop during precount (first four counts of program) before entering new programs in memory.
- At playback, settings are at initially written states. Lower tone keys do not sound when FINGERED or Casio Chord ON have been specified.
- Select key and record key do not function when sustain pedal is ON, or when EDIT or WRITE modes are selected.
- Chord/operation memory is erased when mode key is pressed.
- When memory capacity is exceeded, rhythm stops and 2 LEDs of tempo indicator above start/stop key light together. Press the start/stop key or record key to exit from this state.

12 Pattern Memory

The HT-700 features a pattern memory, which is capable of storing ten different patterns of up to two measures each. These patterns may consist of rhythms, bass lines and accompanying chords. In addition, a one measure fill-in may be programmed corresponding to each 2-measure pattern.

Programming of these patterns is very similar to edit and write procedures, as the mode key, data key and tempo/entry dial are used. Each element of the pattern—rhythm, bass and chord—features two different modes, REHEARSE and WRITE. The REHEARSE mode lets you do just that, practice, while the WRITE mode is used to enter the element into the overall pattern memory.

MODE NO.		TONE EDIT		TOTAL CONTROL		WRITE		DATA	
MELODY TONE	CHORD TONE	DC/LFO	VCF	NO. 60	CHORUS	NO. 90	MELODY TONE	0	REHEARSE
00	30			70	TRANSPOSE	91	CHORD TONE	1	WRITE
10	40			80	MIDI BASIC CH	92	RHYTHM PATTERN	2	SAVE
20	50			81	MIDI CLOCK	93	BASS PATTERN	3	LOAD
					DCA	94	CHORD PATTERN		
						95	CHORD/OPERATION		

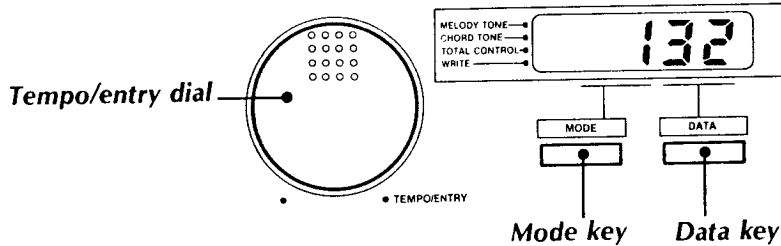

[How to program rhythm patterns]

It's probably easiest to start your programming with the rhythm track. This pattern may consist of 2 bars featuring up to 15 different percussion sounds, and accents.

- ① Select the preset, internal or card (using optional RAM card) rhythm which is closest to the type you want to program. Adjust the tempo speed which you desired for programming.

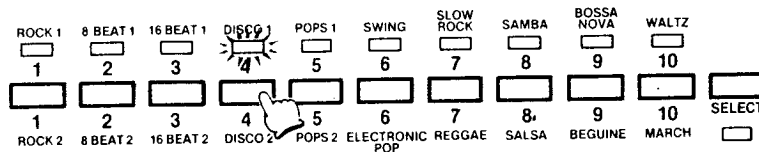

- ② Press the mode key.

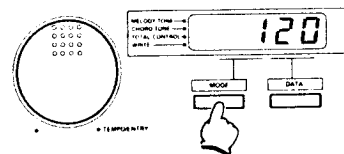

- ③ Turn the tempo/entry dial to the right to select parameter number "92", corresponding to the rhythm pattern.

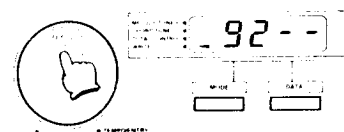

12. Pattern Memory

- ④ Press the data key.

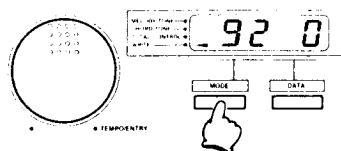

- ⑤ Turn the tempo/entry dial to select WRITE mode (No. 1) (or REHEARSE mode (No. 0), if you want to practice first).

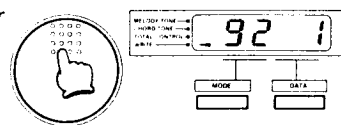

- ⑥ Press the start/stop key to begin programming of 2-measure pattern, or fill-in key to begin programming of 1-measure fill-in.

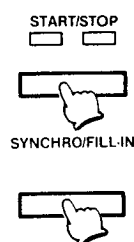

- ⑦ Percussion sounds may be entered by playing corresponding keys in real time. Note that the tempo indicators act as a metronome in this mode.

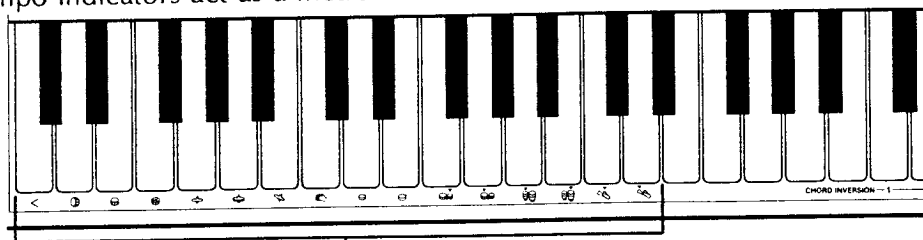

Percussion keys

- Programmed pattern will repeat at the end of the second measure.
- Hold down delete key to delete any or all of this pattern. Pattern will be deleted for as long as the delete key and percussion key are held down. (Press delete key first.)

NOTE: Press delete key before pressing start/stop key to clear the overall pattern in rhythm.

- Accents may be added to any beat via the accent key. Press the accent key on the timing the percussion sounds.

- ⑧ When you are satisfied with one instrument's part, select the next by pressing another percussion key.

- ⑨ Repeat steps (1) through (8) to program other percussion instrument sounds in the pattern.

- ⑩ Press the start/stop key to stop the completed pattern.

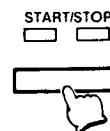

① Press the rhythm key which is desired in memory.

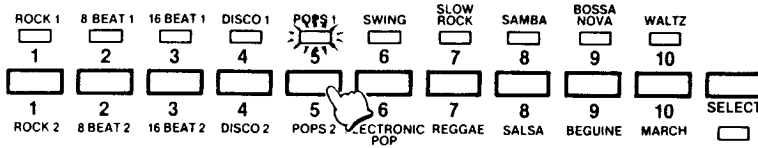

- Your programmed pattern is now entered into the internal memory which you specified. (Programmed pattern can be entered into RAM card.)

[How to program bass patterns]

The next step in building a pattern is programming a bass pattern. This is done by playing a simple bass line on the bass line keys. The bass timbre is preset.

① Press the mode key.

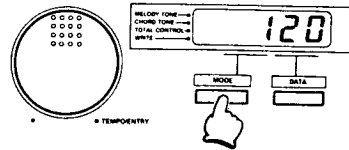

② Turn the tempo/entry dial to the right to select parameter number "93", corresponding to the bass pattern.

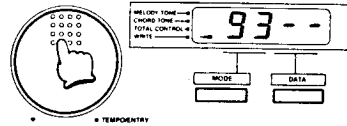

③ Press the data key.

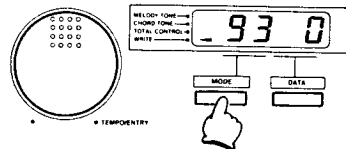

④ Turn the tempo/entry dial to select write mode (No. 1) (or REHEARSE mode (No. 0) if you want to practice first).

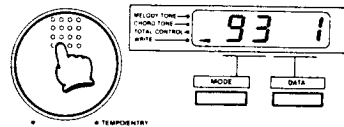

⑤ Press the start/stop key to begin programming of 2-measure pattern, or fill-in key to begin programming of 1-measure fill-in.

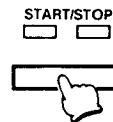

② Turn the tempo/entry dial to the right to select parameter number "94", corresponding to the chord pattern.

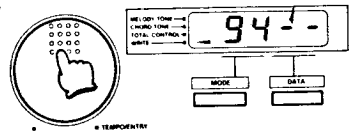

③ Press the data key.

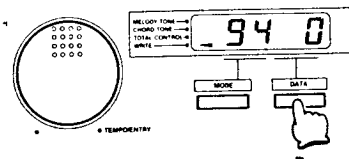

④ Turn the tempo/entry dial to select write mode (or REHEARSE mode (No. 0), if you want to practice first).

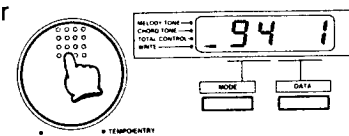

- ⑤ Press the start/stop key to begin programming of 2-measure pattern, or fill-in key to begin programming of 1-measure fill-in.
- ⑥ Add chord accompaniment by playing in real time.

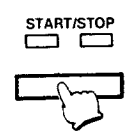

- Chords may be inverted via the chord inversion function. A total of 8 different inversions are possible.

<CHORD INVERSIONS>

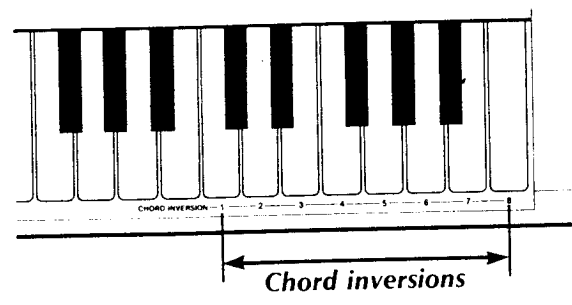

- Chord inversion is performed by tapping corresponding keys.
- Programmed pattern will repeat at the end of the second measure.
- Hold down delete key to delete any or all of this pattern. Pattern will be deleted for as long as the key is held down.

NOTE: Press delete key before pressing start/stop key to clear the overall pattern in chord.



12. Pattern Memory

⑦ Press the start/stop key to stop the completed pattern.

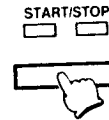

⑧ Press the rhythm key which is desired in memory.

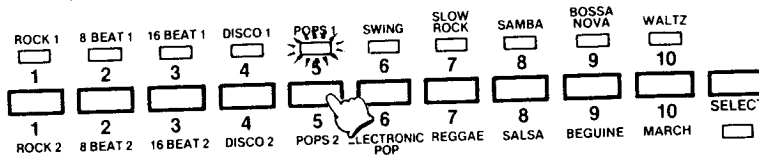

- Your programmed pattern is now entered into the internal memory which you specified. (Programmed pattern can be entered into RAM card.)

[How to "play" programmed patterns]

Now that your pattern is complete, you can "play" it by playing Casio Chord progressions on the lower tone of the keyboard, and playing original melodies on the upper tone.

① Press the rhythm key to select the program to be played back.

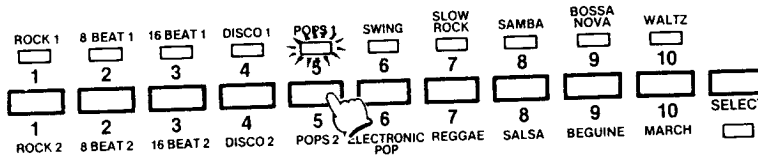

② Press the start/stop key.

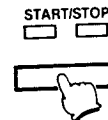

- The programmed rhythm track will start.
- The bass line and chord accompaniment begins when any lower tone key on the keyboard is played. Bass lines automatically follow the progression of chord changes at any point in the pattern.
- Melodies can be played on the upper tone keys on the keyboard. Select the timbre via the tone keys.
- Percussion fill-in patterns can be played at any point by pressing the synchro/fill-in key.

13 Save/Load Operation

Edited tone data, pattern, and chord/operation programs can be saved via RAM card (optional RA-100), for recall at a later time. In order to save or load a program, it's necessary to specify the data to be saved/loaded via the corresponding parameter. These are listed below:

MELODY TONE = 90
CHORD TONE = 91
PATTERN DATA = 92, 93, 94
CHORD/OPERATION MEMORY = 95

■ SAVE/LOAD PROCEDURE ■

① Press the mode key.

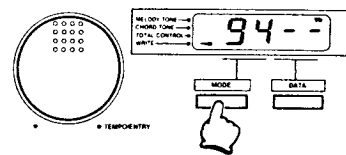

② Turn the tempo/entry dial to the desired mode.

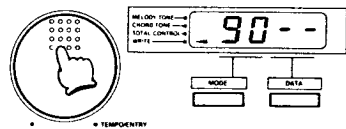

③ Press the data key to enter specified parameter.

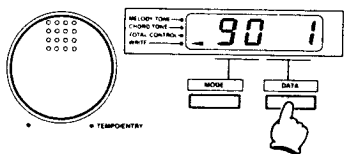

④ Turn the tempo/entry dial to either SAVE (2), or LOAD (3).

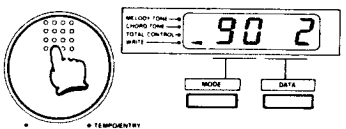

⑤ Press the data key.

- Data is transferred to or from RAM card. (Display is returned to tempo.)

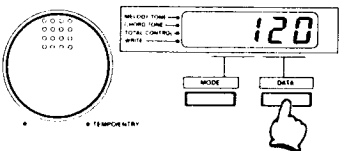

14 Key Transpose

To transpose the key of the entire keyboard, refer to the following procedures.

① Press the mode key.

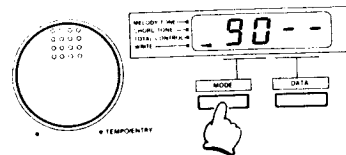

② Turn the tempo/entry dial so that display shows parameter "70."

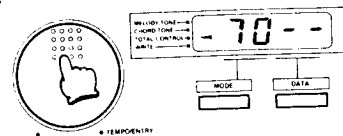

③ Press the data key.

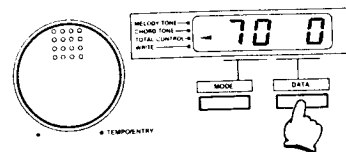

④ Raise or lower pitch via dial, within the range as shown below:

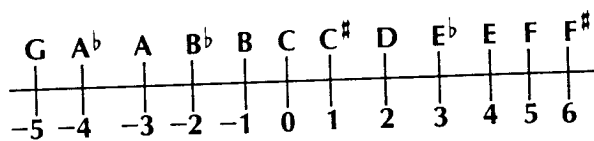

⑤ Press the data key once again to return to normal operating mode. (Display is returned to tempo.)

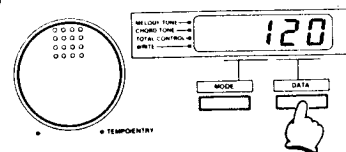

15 MIDI

“MIDI” stands for “Musical Instrument Digital Interface.” Practically speaking, it allows connection and synchronized performance via electronic musical instruments such as synthesizers, drum machines and sequencers, and even personal computers. The HT-700 features 4 basic MIDI modes:

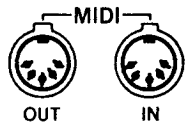

MIDI INReceives MIDI signal from external device.

MIDI OUTSends MIDI signal to external device.

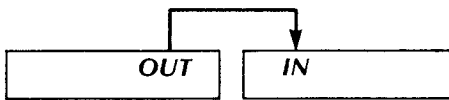

(MIDI mode A)

Sends/Receives MIDI messages as a single keyboard (8-note poly).

<EXAMPLE CONNECTION>

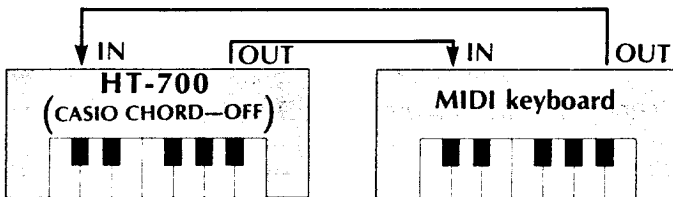

(MIDI mode B)

Splits keyboard into 3 sections; a 4-note poly section (Upper melody), a 3-note poly section (Chord) and a mono section (Bass) for use as a multiple sound source.

<EXAMPLE CONNECTION>

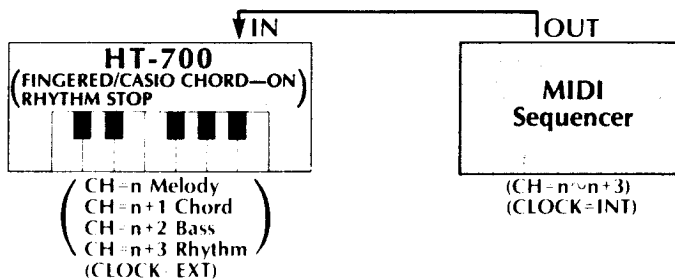

15. MIDI

(MIDI mode C)

Sends multiple MIDI messages for both accompaniment pattern and melody performance (for use as a backing sequencer by chord/operation memory).

<EXAMPLE CONNECTION>

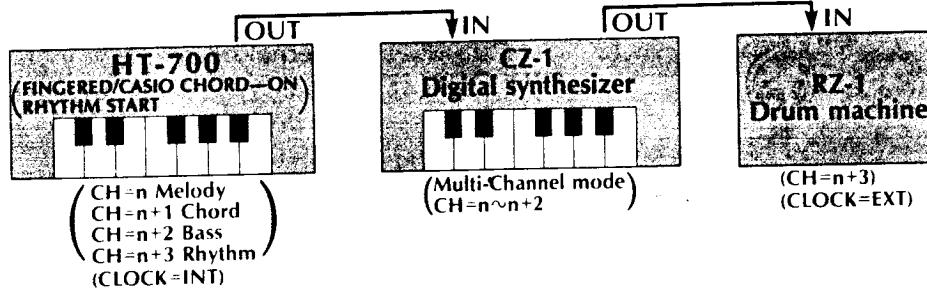

■ SETTING MIDI CHANNEL ■

In order to communicate with other MIDI devices, the MIDI channel numbers of both units must match.

① Press the mode key.

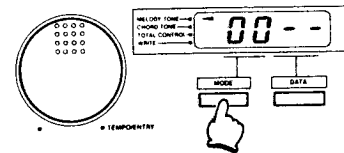

② Turn the tempo/entry dial to parameter number "80".

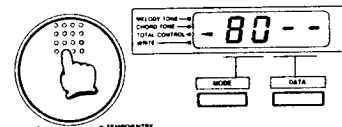

③ Press the data key.

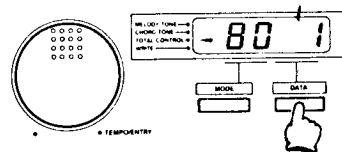

④ Turn the tempo/entry dial to the desired MIDI channel number.

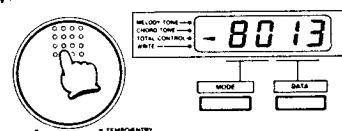

⑤ Press the data key once again to exit from mode. (Display is returned to tempo.)

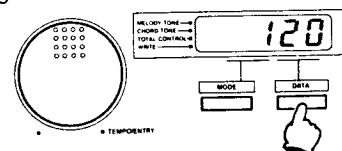

■ SETTING MIDI CLOCK MODE ■

The HT-700's MIDI Clock features two operational modes, internal or external.

① Press the mode key.

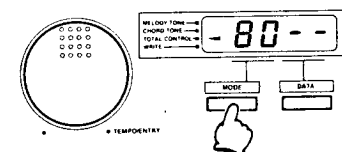

② Turn the tempo/entry dial to parameter number "81".

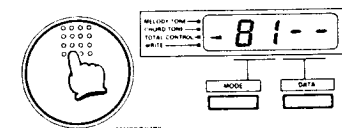

③ Press the data key.

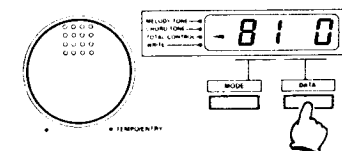

15. MIDI

- ④ Turn the tempo/entry dial to select either INTERNAL CLOCK (0) or EXTERNAL CLOCK (1) modes.

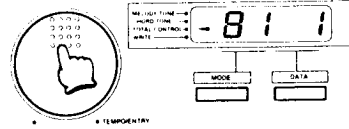

- ⑤ Press the data key once again to exit from mode. (Display is returned to tempo.)

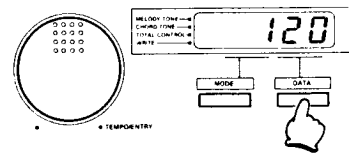

16 RAM Card

An optional RAM card can be utilized with the HT-700 to increase its memory potential.
In order to use the card, it's first necessary to format the card via the following procedures.

- ① Insert the RAM card into the RAM card slot.

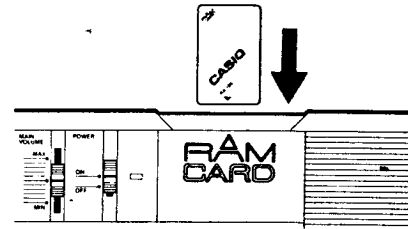

- ② Hold down the mode key and data key, and press the "CARD" tone source key.

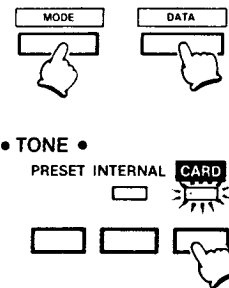

- The display shows "CF" during formatting.
- This formats the RAM card, preparing it for use in the HT-700.
- When the RAM card is not inserted in the unit, RAM card rhythms, tones, and memories do not operate. When an improper card is inserted, an "E" message on the display indicates an error.
- Do not remove the card while formatting, or during SAVE or LOAD operations.

17 Troubleshooting

18

*For any malfunction, always check battery condition first. (see page 10)

Trouble	Possible Cause	Remedy
No sound, even if keys are pressed.	1. Main volume turned down. 2. Headphones connected.	1. Turn up main volume. 2. Disconnect headphones.
No rhythm.	Rhythm volume turned down.	Turn up rhythm volume.
No accompaniment.	Main and accompaniment volume turned down.	Turn up main and accompaniment volume.
Occasional interference.	Refrigerators, washing machines and similar electric appliances.	Use outlet as far away as possible from appliance thought to be the cause.
No sound when connected to external amplifier.	1. Main volume turned down. 2. Defective connection cord.	1. Turn up main volume. 2. Replace connection cord.

 1. L
 T
 of
 • In
 • Ex
 • In
 2. P
 U
 a
 3. F
 D
 a
 4. K
 C
 b
 5. I
 In
 a
 U
 t
 6. F
 S

18 Care of Your Keyboard



Please observe the following precautions to assure safety and reliability.

1. Location

To avoid malfunction, do not use this unit in the following locations for extended periods of time:

- In direct sunlight.
- Exposed to extremes of temperature or humidity.
- In sandy or dusty places.

2. Power supply

Use only with rated voltage. Also, to help prevent noise and degraded sound quality, avoid using the same outlet for other equipment—particularly household appliances.

3. Handle gently

Do not drop the unit, as strong shocks will definitely cause malfunctions. Also, sliders and keys are designed to operate with a light touch. Excessive force may cause damage.

4. Keep it clean

Clean the keyboard with a soft cloth dampened with detergent. Never use paint thinner, benzene or other solvents.

5. In case of malfunction...

In the event that your keyboard does not function properly, check whether connections are made correctly, and that the unit is supplied with power (are batteries dead?). If the unit still does not work, contact the original retailer or local Casio dealer. Never attempt to repair the unit yourself.

6. Keep this manual

Store this manual in a safe place for future reference.

19 Specifications

Model:	HT-700
Number of keys:	49 keys (mini)
Polyphonic:	8-note
Upper tone:	Preset—20, Internal—20, RAM card (option)—20
Auto-rhythm:	Preset—20, Internal—10, RAM card (option)—10
Auto-accompaniment function:	Casio Chord ON/OFF, FINGERED
Key split:	Split point × 2
Effect:	Pitch bender, Chorus, Key transpose
Chord/Operation memory:	Chord memory—640 chords MAX. × 4 banks (Using optional RAM card) Operation memory—198 settings MAX. × 4 banks (Using optional RAM card)
Synthesizing:	<p>(Upper tone edit) DCO/LFO: SOUND SOURCE 0—31, LFO DEPTH 0—31, LFO WAVEFORM 0—4, LFO DELAY 0—31, LFO SPEED 0—31 VCF: CUTOFF FREQUENCY 0—31, RESONANCE 0—7, ATTACK TIME 0—31, DECAY TIME 0—31, SUSTAIN LEVEL 0—31, RELEASE TIME 0—31, ENVELOPE DEPTH 0—31 DCA: ATTACK TIME 0—31, DECAY TIME 0—31, SUSTAIN LEVEL 0—31, RELEASE TIME 0—31, ENVELOPE DEPTH 0—31 CHOURS: 0—3</p> <p>(Lower tone edit) DCO/LFO: SOUND SOURCE 0—15, LFO 0—2 (OFF, ON, DELAY) VCF: CUTOFF FREQUENCY 0—31, RESONANCE 0—7, ATTACK TIME 0—31, DECAY TIME 0—31, SUSTAIN LEVEL 0—31, RELEASE TIME 0—31, ENVELOPE DEPTH 0—31 DCA: ATTACK TIME 0—31, DECAY TIME 0—31, SUSTAIN LEVEL 0—31, RELEASE TIME 0—31, ENVELOPE DEPTH 0—31</p>
Pattern program:	<p>Rhythm pattern: 20 patterns memory MAX. (Using optional RAM card) [2 bars + 1 bar (fill-in)] Bass pattern: 20 patterns memory MAX. (Using optional RAM card) [2 bars + 1 bar (fill-in)] Chord pattern: 20 patterns memory MAX. (Using optional RAM card) [2 bars + 1 bar (fill-in)]</p>
Terminals:	Line out (output impedance 100Ω, Output voltage 0.8V (RMS) MAX.) Phones × 1, AC adaptor (DC 9V), Sustain × 1, MIDI (OUT/IN)

19. Specifications

Tuning control:	±50 cents (±1/4 tones)
Built-in speakers:	10cm dia. × 2 (output: 1W + 1W)
Auto power off function:	6 minutes after last operation
Power source:	3-way AC/DC power source; <ul style="list-style-type: none">• AC: 100, 117, 220 or 240V (±10V), 50/60 Hz, with optional AC adaptor AD-5.• DC: 6 D size manganese dry batteries. Battery life: Approximately 10 hours (SUM-1).• Car battery: Power taken via optional car adaptor CA-5.
Power consumption:	7W
Dimensions:	690 (W) × 241 (D) × 90 (H) mm 27 3/16" (W) × 9 1/2" (D) × 3 9/16" (H)
Weight:	3.9 Kg (8.5 lbs) including batteries
Standard accessories:	6 "D" size batteries

**Design and specifications are subject to change without notice.*

GUIDELINES LAID DOWN BY FCC RULES FOR USE OF THE UNIT IN THE U.S.A. (not applicable to other areas).

This equipment generates and uses radio frequency energy and if not installed and used properly, that is, in strict accordance with the manufacturer's instructions, may cause interference to radio and television reception. It has been type tested and found to comply with the limits for a Class B computing device in accordance with the specifications in Subpart J of Part 15 of FCC Rules, which are designed to provide reasonable protection against such interference in a residential installation. However, there is no guarantee that interference will not occur in a particular installation. If this equipment does cause interference to radio or television reception, which can be determined by turning the equipment off and on, the user is encouraged to try to correct the interference by one or more of the following measures:

- reorient the receiving antenna
- relocate the computer with respect to the receiver
- move the computer away from the receiver
- plug the computer into a different outlet so that computer and receiver are on different branch circuits.

If necessary, the user should consult the dealer or an experienced radio/television technician for additional suggestions. The user may find the following booklet prepared by the Federal Communications Commission helpful: "How to Identify and Resolve Radio-TV Interference Problems." This booklet is available from the US Government Printing Office, Washington, D.C., 20402, Stock No. 004-000-00345-4.

Model HT-700 MIDI Implementation Chart

Function...	Transmitted	Recognized	Remarks
Basic Default Channel Changed	1 1-13	1 1-13	Send channel=receive channel
Mode Default Messages Altered	Mode 3 X *****	Mode 3 X	
Note Number: True voice	36-84 *****	0-127 36-96	0-11, 12-23, 24-35=36-47 97-108, 109-120, 121-127=85-96
Velocity Note ON Note OFF	X 9n v=64 X 9n v=0	X 9n v=1-127→64 X 9n v=0, 8n v=XX	X... No function
After Key's Touch Ch's	X X	X X	
Pitch Bender	○	○	8 significant bits
Control Change 64	○	○	Sustain pedal,
Prog Change: True*	○ 0-59 *****	○ 0-59	0-59 when RAM card used, 0-39 when not used
System Exclusive	X	X	
System : Song Pos : Song Sel Common : Tune	X X X	X X X	
System : Clock Real Time : Command	○ ○	○ ○	Continue not sent
Aux : Local ON/OFF : All Notes OFF Mes- : Active Sense sages : Reset	X X X X	X X X X	
Notes			

Mode 1: OMNI ON, POLY
Mode 3: OMNI OFF, POLY

Mode 2: OMNI ON, MONO
Mode 4: OMNI OFF, MONO

○: Yes
X: No