MORPHEUS

Operation Manual

© 1993 E-mu Systems, Inc.

All Rights Reserved

- FI420 Rev. C

Manual - Riley Smith

E-mu World Headquarters
E-mu Systems, Inc. U.S.A.
P.O. Box 660015
Scotts Valley, CA USA
95067-0015
Telephone: 831-438-1921
Fax: 831-438-8612

Europe, Africa, Middle East
E-mu Systems, Ltd.
Suite 6, Adam Ferguson
House
Eskmills Industrial Park
Musselburgh, East Lothian
Scotland, EH21 7PQ
Telephone: 44-31-653-6556
Fax: 44-31-665-0473

Important Notice:

In order to obtain warranty service on your Morpheus unit, the serial number sticker must be intact and you must have a sales receipt or other proof of purchase. If there is no serial number sticker on Morpheus, please contact E-mu Systems at once.

This product is covered under one or more of the following U. S. patents: 3,969,682; 3,986,423; 4,404,529; 4,506,579; 4,699,038; 4,987,600; 5,013,105; 5,072,645; 5,111,727 and foreign patents and/or pending patents. Morpheus is a registered trademark of E-mu Systems, Inc.

IMPORTANT SAFETY INSTRUCTIONS

Use in countries other than the U.S.A. may require the use of a different line cord or attachment plug, or both. To reduce the risk of fire or electric shock, refer servicing to qualified service personnel. To reduce risk of fire or electric shock do not expose this product to rain or moisture.

GROUNDING INSTRUCTIONS

This product must be grounded. If it should malfunction or break down, grounding provides a path of least resistance for electric current, reducing the risk of electric shock. This product is equipped with a cord having an equipment-grounding conductor and a grounding plug. The plug must be plugged into an appropriate outlet properly installed and grounded in accordance with all local codes and ordinances.

DANGER

Improper connection of equipment grounding conductor can result in the risk of electric shock. Check with a qualified electrician or service personnel if you are in doubt as to whether the product is properly grounded. Do not modify the plug provided with this product — if it will not fit the outlet, have a proper outlet installed by a qualified technician.

CAUTION

If the Morpheus (model number 9053), is rack mounted, a standard 19-inch open frame rack must be used.

USER-MAINTENANCE INSTRUCTIONS

1. Morpheus should be kept clean and dust free. Periodically wipe the unit with a clean, lint free cloth. Do not use solvents or cleaners.
2. There are no user lubrication or adjustment requirements.
3. Refer all other servicing to qualified service personnel.

INSTRUCTIONS PERTAINING TO A RISK OF FIRE, ELECTRIC SHOCK, OR INJURY TO PERSONS

WARNING; When using electric products, basic precautions should always be followed, including the following:

1. Read all instructions before using Morpheus.
2. To reduce the risk of injury, close supervision is necessary when Morpheus is used near children.
3. Do not use Morpheus near water — for example near a bathtub, washbowl, kitchen sink, in a wet basement, on a wet bar, or near or in a swimming pool.

In this document, whenever the word "Morpheus" is mentioned we are referring to the Morpheus Synthesizer by E-mu Systems, Inc.



This symbol is intended to alert the user to the presence of important operating and maintenance (servicing) instructions in the literature accompanying the appliance.



This symbol is intended to alert the user to the presence of uninsulated dangerous voltage within the product's enclosure that may be of sufficient magnitude to constitute a risk of electric shock to persons.

SAVE THESE INSTRUCTIONS

4. Morpheus should be situated so that its location or position does not interfere with its proper ventilation.
5. Morpheus should be located away from heat sources such as radiators, heat registers, fireplaces, stoves, or ovens.
6. Morpheus should only be connected to a power supply of the type described in the operating instructions and as marked on the product.
7. This product, in combination with an amplifier, headphones, and speakers, may be capable of producing sound levels that could cause full or partial hearing loss or damaged equipment. Do not operate for long periods of time at high volume levels or at a level that is uncomfortable. Additionally, care must be taken when programming any of the filters contained herein using extreme operating parameters. This action could also produce signals which result in unacceptable high sound levels as noted previously. If you experience any hearing loss or ringing of the ears consult your physician.
8. Morpheus may be equipped with a polarized line plug (one blade wider than the other). This is a safety feature. If you are unable to insert this plug into the outlet, do not defeat the safety purpose of the plug. Contact an electrician to replace your obsolete outlet.
9. The power supply cord of Morpheus should be unplugged from the outlet when left unused for a long period of time.
10. Care should be taken so that objects do not fall and liquids are not spilled into the enclosure of Morpheus through openings.
11. The product should be serviced by qualified service personnel when:
 - A. The power supply cord has been damaged; or
 - B. Objects have fallen, or liquid has been spilled into the product; or
 - C. The product has been exposed to rain; or
 - D. The product does not appear to operate normally or exhibits a marked change in performance; or
 - E. The product has been dropped or the enclosure damaged.
12. All servicing should be referred to qualified service personnel.

SAVE THESE INSTRUCTIONS

INTRODUCTION & BASIC SETUP	1
Introduction	3
Getting Started	4
Connection Instructions	5
Background - About Sampling	9
BASIC OPERATION	11
Main Controls	12
Selecting MIDI Channels	14
Selecting Presets/Hyperpresets	14
Adjusting Volume & Pan Position	14
Memory Card	15
Midimap Selection	15
Multi-Timbral Operation	16
Playing the Demo Sequences	16
MASTER MENU	17
Enabling the Master Menu	19
Master Tune	19
Transpose	19
User Key Tuning	20
Global Bend	20
Global Velocity Curve	20
MIDI Mode	22
MIDI Mode Change	22
MIDI Program Change Map	23
MIDI Controller Assign	24
MIDI Footswitch Control	24
Send MIDI Data	24
Sysex Packet Delay	25
Proteus Sysex	26
Auto Select	26
Compare Mode	26
Viewing Angle	26
MIDIMAP MENU	27
The Midimap	29
Enabling the Midimap Menu	30
Midimap Select	30
Midimap Name	31
Program to Channel Assign	31

MIDIMAP MENU (cont)	
Volume, Pan & Output Mix	31
MIDI Enables	33
Bank Select	33
Program Map Select	34
FX A	34
FX B	35
FX Amount	35
FX Output Select	36
Save Midimap	36
EFFECTS SECTION	37
Where are the Effects?	39
Effects Output Routing	40
Morpheus Effects Bus Architecture	40
Effect Programming Instructions	41
Reverb	42
Stereo Flanger	46
Stereo Phaser	48
Stereo Chorus	49
Stereo Delay	50
Stereo Cross Delay	51
Stereo Echo	52
"B" Effects	53
Stereo Fuzz	54
Ring Modulator	55
HYPERPRESET MENU	57
The Hyperpreset	59
Enabling the Hyperpreset Menu	59
Hyperpreset Name	60
Preset to Zone Assignment	60
Zone Volume and Pan	61
Zone Key Range	61
Zone Velocity Range	62
Zone Velocity Offset	63
Zone Transpose	63
Zone Pitch Tune	63
Hyperpreset Portamento Mode	64
Free-Run Function Generator	64
Save Hyperpreset	66

PRESET PROGRAMMING	67
Starting to Program	69
Modulation	70
Modulation Sources	71
Footswitch Modulation	72
Midipatch	72
Envelope Generators	73
Low Frequency Oscillators	75
Function Generators	76
Filter Modulation	84
Parametric Filters	87
The Morpheus Filter	88
The Z-Plane Filter	89
Another View	92
Morpheus Signal Flow	93
Note-On Modulation Control	94
Realtime Modulation Control	95
Key Number	96
Velocity Curves	96
MIDI Realtime Controls	97
PRESET MENU	99
Enabling the Preset Menu	101
Preset Name	102
Primary Instrument	102
Secondary Instrument	102
Volume	103
Pan	103
Key Range	103
Primary Key Range	104
Secondary Key Range	104
Transpose	105
Coarse Pitch Tuning	105
Fine Pitch Tuning	105
Alternate Envelope On/Off	105
Primary Alternate Envelope Parameters	106
Secondary Alternate Envelope Parameters	106
Double + Detune	106
Sound Delay	107
Sound Start	107

PRESET MENU (cont)

Sound Reverse.....	107
Nontranspose	108
Loop Enable	108
Loop Offset	108
Solo Mode	109
Solo Mode Priority	110
Portamento Rate	110
Portamento Shape	110
Portamento Mode.....	111
Crossfade Mode	111
Crossfade Direction.....	112
Crossfade Balance and Amount	112
Cross-switch Point	113
Primary Filter Type	113
Secondary Filter Type.....	113
Filter Level	113
Morph Offset	114
Filter Frequency Tracking	114
Filter Transform 2	115
Filter Reverse	116
Auxiliary Envelope	116
LFO 1 & 2 - Shape & Amount.....	117
LFO 1 & 2 - Rate, Delay & Variation	117
Function Generator 1 and 2	118
Note-On Modulation Control	122
Realtime Modulation Control	123
Footswitch Control	124
Pitch Bend Range.....	124
Pressure Amount	124
MIDI Controller Amount	124
Velocity Curve.....	125
Keyboard Center	126
Keyboard Tuning	126
Mix Select	127
Save Preset	127

COPY MENU	129
Enabling the Copy Menu	131
Copy Preset	131
Copy Layer	132
Copy Filter	132
Copy LFO	132
Copy Function Generator	133
Copy Auxiliary Envelope	133
Copy Note-On Control	133
Copy Realtime Control	133
Copy Hyperpreset	134
Copy Zone	134
Copy Free-Run Function Generator	134
Copy Midimap	134
Copy Channel	135
Copy Effects	135
Copy Program Change Map	135
Copy Bank	136
STEP-BY-STEP	137
Forward	139
Editing Presets	139
Starting From Scratch	140
The Instrument	140
Volume	141
Pan	141
Transpose	141
Coarse Tuning	142
Fine Tuning	142
Alternate Volume Envelope	143
Anatomy of an Envelope	144
Sound Delay	145
Sound Start	145
Application: Sound Splicing	146
Time to Save?	147
LFO Modulation	147
Modulating Modulators	150
The Morpheus Filter	151
Just Do It	152
Filter Philosophy	154
Morphology	157

CONTENTS

Using Morpheus with a Sequencer	158
More Advanced Sequencing	159
REFERENCE SECTION	161
Factory RAM Presets - Bank 0	162
Factory ROM Presets - Bank 1	163
Instrument Listing	164
B3 Wave Diagrams	169
Percussion Instrument Locations	170
Z-Plane Filter Descriptions	174
Loop Offset Sample Locations	211
Function Generator Curves	214
Function Generator, LFO & Envelope Specifications	222
Technical Specifications	223
MIDI Implementation Chart	224
MIDI Specifications	225
MIDI SysEx Tutorial	251
INDEX	255

INTRODUCTION & BASIC SETUP



MORPHEUS Z-PLANE SYNTHESIZER

Morpheus is a completely new type of music synthesizer which represents a major landmark in the evolution of electronic sound synthesis.

Many electronic instruments involve the technology of sampling, where sounds are digitally recorded and played back at different pitches. Sampling has the advantage of highly accurate and realistic sound. One disadvantage of sampling is that once the sounds are recorded, it is difficult to change them in any significant way.

Morpheus introduces the Z-Plane filter, which has the ability to smoothly change its function over time. This ultra-powerful device can accurately simulate the resonance of musical instruments, the human voice or create entirely new timbres. The Z-Plane filter is composed of up to eight complex filters for unprecedented control over subtle aspects of the sound.

Morpheus contains eight megabytes (internally expandable to 16 megabytes) of the highest quality 16 bit samples as the basis for its sounds. These sounds can be combined or spliced, modulated and then shaped through one of 197 Z-Plane filters. Sampled sounds can now be re-shaped and expressively controlled.

The 16 bit sound samples are arranged into 256 preset locations, 128 of which are user-programmable. 128 user-programmable Hyperpresets allow ultra-flexible keyboard mapping of presets. The optional memory card lets you create an expandable library of your favorite presets and hyperpresets.

Morpheus features two studio-quality effects processors with 28 different effects to choose from. Hyperpresets allow you to have up to 32 different sounds on the keyboard at one time in any desired arrangement. Sounds can be placed side by side or layered with velocity control. The ability to respond multi-timbrally to all 16 MIDI channels makes Morpheus ideally suited for multitrack sequencing and composing using a MIDI sequencer.

Other features include 3 stereo outputs for individually processing sounds (also configurable as 6 polyphonic submixes with fully programmable panning), integral sends and returns to allow the addition of external effects units without the need for a separate mixer, user definable alternate tuning, and of course, an extensive MIDI implementation.

In its most basic form, Morpheus is organized as shown in the diagram below. Complete acoustic instrument samples and electronically created sounds are used as raw material to form Presets.

The Preset is a complete set of all program functions and combinations for a complete Morpheus sound. Each preset consists of one or two Instruments. An Instrument is a complete set of samples or a digital waveform which covers the entire keyboard range. An instrument can be assigned to each of the Primary and Secondary layers of the preset.

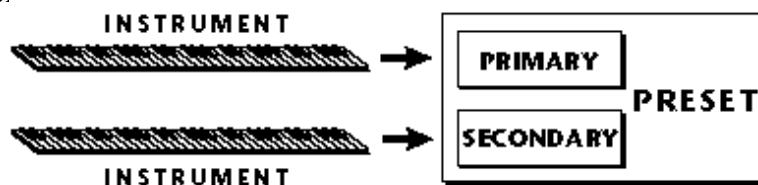

The primary and secondary layers of the preset are essentially two instruments with complete modulation controls. The memory is organized into banks of 128 programmable RAM presets, unalterable ROM presets and Hyperpresets.

Bank Contents	
0	- RAM Presets
1	- ROM Presets
2	- RAM Hyperpresets
3	- Card Presets
4	- Card Hyperpresets

A Hyperpreset is a combination of up to sixteen presets arranged either side by side on the keyboard (to create a keyboard split) or on top of each other (to create a denser sound). Each preset in a hyperpreset is assigned to a keyboard Zone, with an associated key range, volume, pan, tuning and transpose setting. In addition, each zone can be assigned to a velocity range so that different presets can play depending on the key velocity. There are 128 Hyperpreset locations available to store your own custom keyboard setups.

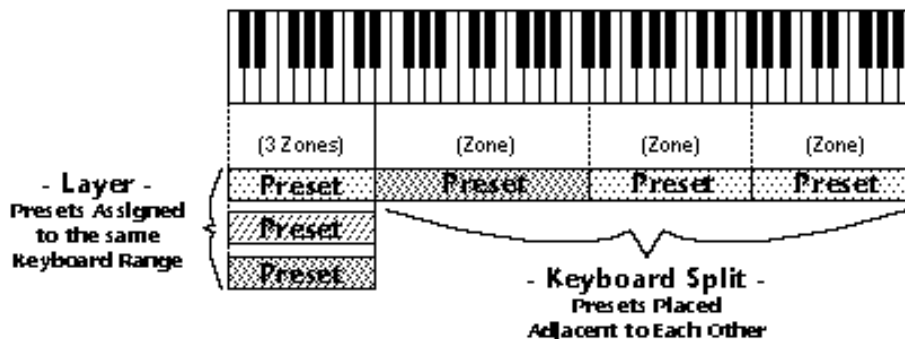

RAM Presets can be moved, erased or modified as desired.

ROM Presets cannot be moved or altered unless they are first copied to a RAM location.

Hyperpresets are groups of presets arranged on the keyboard to form splits or layers.

Memory Card - Allows you to easily load and save additional Presets and hyperpresets.

SETUP #1 BASIC SETUP

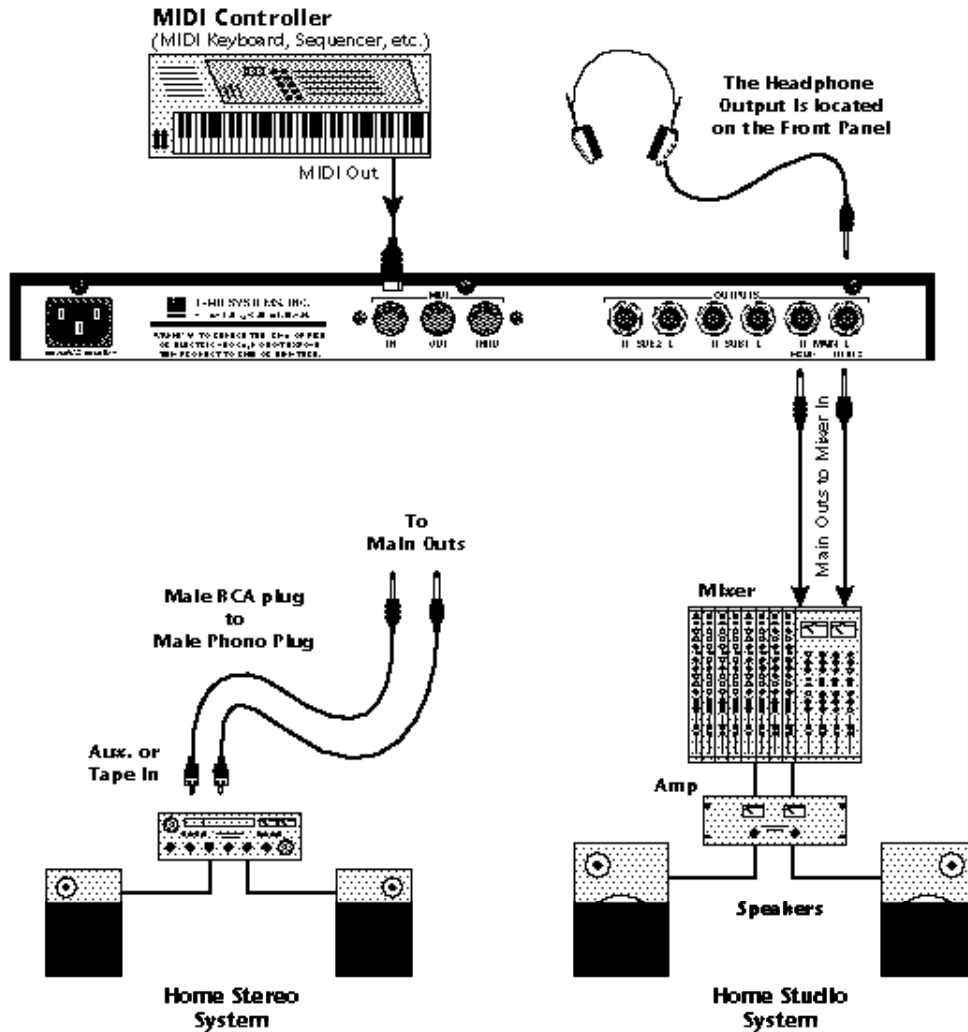

▼ The headphone output monitors the main outputs only. The submix outputs do NOT feed into the headphone output.

• • • If Morpheus does not seem to be responding correctly, make sure that both Morpheus and your MIDI controller are set to the same MIDI channel.

MIDI In

Morpheus is controlled by MIDI messages received at the MIDI In connector. Connect the MIDI In of the Morpheus to the MIDI Out connector of a MIDI controller such as a MIDI keyboard, MIDI wind controller or MIDI guitar controller.

Audio Outputs

Morpheus is a high quality, stereo audio device. In order to reproduce its wide dynamic range and frequency response, use a high quality amplification and speaker system such as a keyboard amplifier or home stereo system. A stereo setup is highly desirable because of the added realism of stereophonic sound. Headphones can be used if an amplifier and speaker system is not available. Plug stereo headphones into the headphone jack located on the left side of the front panel. The Right Main output jack serves as a mono output when the Left Main plug is not plugged in.

SETUP #2 STUDIO SETUP

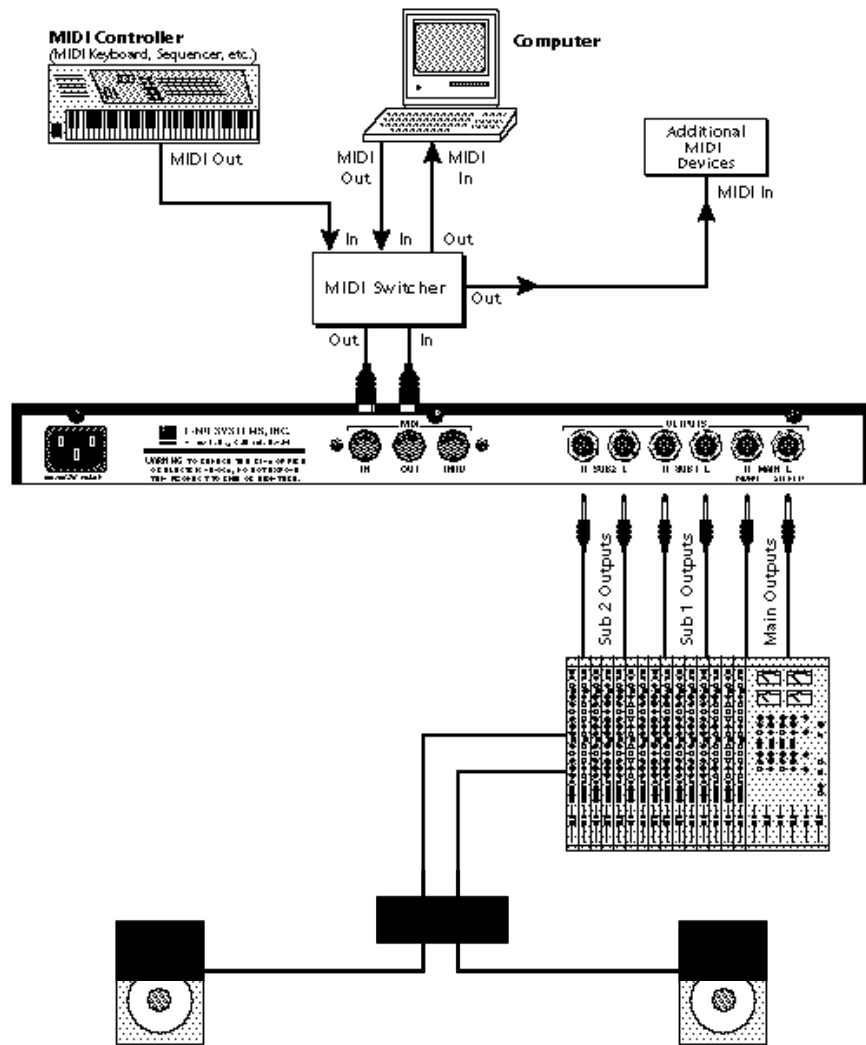

MIDI In

In this setup, Morpheus is controlled by MIDI messages received at the MIDI In connector which have been routed by a MIDI switcher. The MIDI switcher allows any MIDI controller such as a MIDI keyboard, MIDI wind controller or a computer to be easily connected.

MIDI Out

The MIDI Out jack is normally used to transmit MIDI System Exclusive data to a computer or other device.

Audio Outputs

Morpheus has three sets of programmable stereo outputs; Main, Sub 1, and Sub 2. Specific Morpheus presets (or MIDI channels) can be routed to one of these stereo pairs in order to be further processed or mixed separately.

SETUP #3 PERFORMANCE SETUP

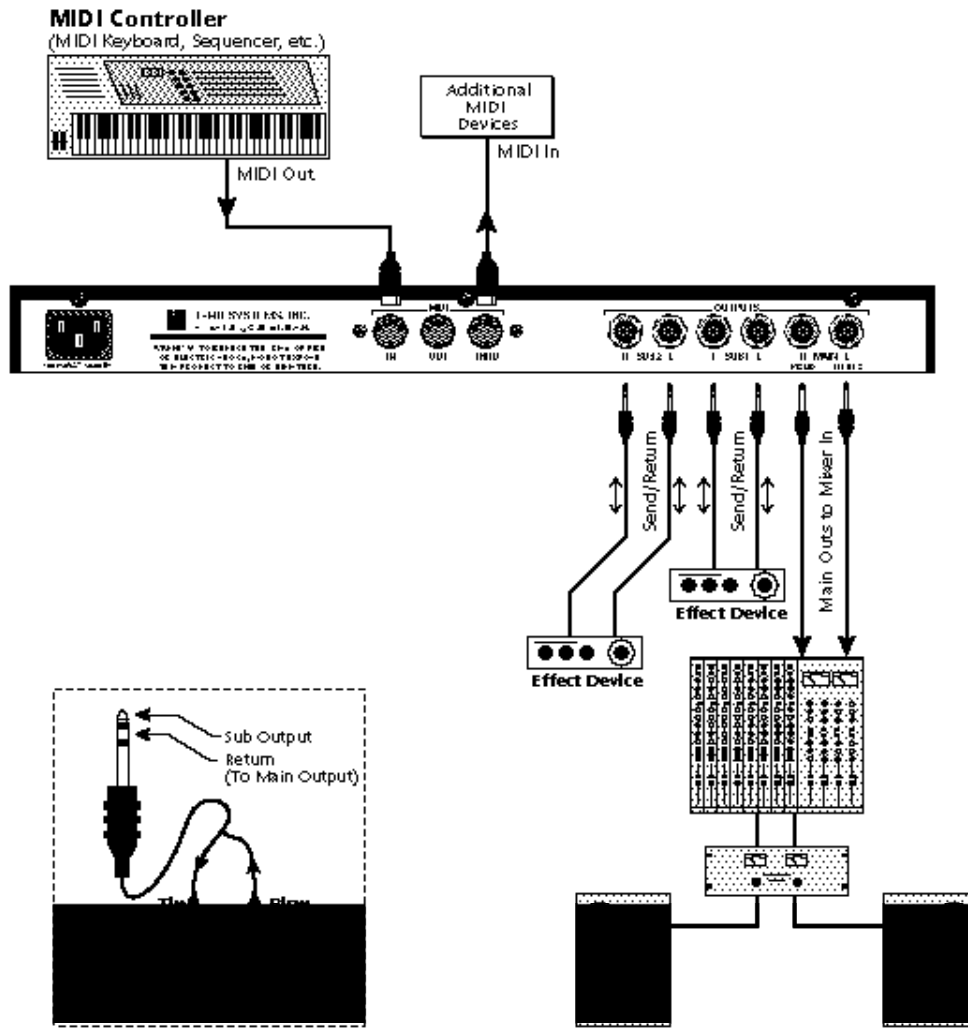

MIDI In

Morpheus is controlled by MIDI messages received at the MIDI In connector. Connect the MIDI In of Morpheus to the MIDI Out connector of a MIDI controller such as a MIDI keyboard, MIDI wind controller or MIDI guitar controller.

MIDI Thru

The MIDI Thru jack is used to connect additional MIDI devices onto the MIDI chain. MIDI Thru transmits an exact copy of the messages received at the MIDI In jack.

Audio Outputs

Each of the Sub 1 and Sub 2 output jacks on the Morpheus are stereo jacks. The tip of each jack (accessed when a standard phone plug is inserted) is the left or right output of that group. The Sub 1 outputs

bypass the internal effects section. The Sub 2 outputs are fed from the effects section. If a stereo plug is inserted, the Ring of the stereo plug serves as a signal Return which sums into the Main outputs.

Therefore, the Sub 1 and Sub 2 jacks can serve as effect sends and returns in order to further process selected instruments and then return them to the main mix.

The diagram shows the Sub 1 and Sub 2 jacks being used as send/returns in order to further process selected Morpheus presets without using the effects bus on the mixing board. In a pinch, the effect returns could also be used to sum additional instruments into the main outputs.

Morpheus Output Section

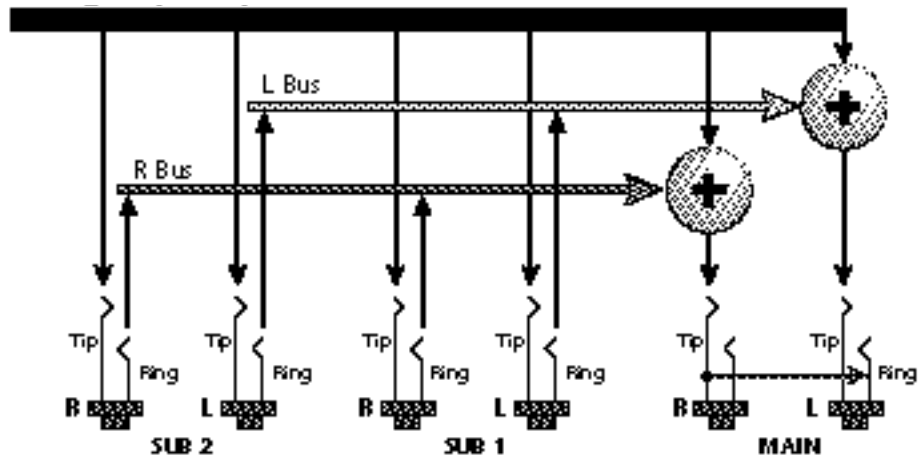

The Sub 1 and Sub 2 jacks can be used as effect returns to the Main Outputs.

POWER UP!

The power switch is located on the right side of the front panel. Morpheus and its MIDI controller may be turned on in any order. When power is applied, the liquid crystal display will light, indicating that Morpheus is operating. You may have noticed that there is no 110/220 Volt power selector switch on Morpheus.

Morpheus automatically switches itself for 110 or 220 Volt operation.

ABOUT SAMPLING

Morpheus utilizes digital recording of acoustic sounds for the basis of each Instrument. This is similar to a tape recorder except that inside the Morpheus, the sounds are permanently recorded on digital memory chips.

Sound and instrument waveforms are first sampled into the Emulator III, our top of the line, 16 bit stereo digital sampler. After the sounds and waveforms have been truncated, looped and processed, they are permanently encoded into the Morpheus ROM (Read Only Memory) chips.

Conceptually, the sampling process is very simple, as shown in the Basic Sampling System diagram. As a sound wave strikes the diaphragm of a microphone, a corresponding voltage is generated. To sample the sound, the voltage level is repeatedly measured over time and the corresponding data values are stored in memory. To play the sound back, the numbers are read back out of memory, modified by the Z-plane filter, converted back into voltages, then amplified and fed to a speaker which converts the voltage back into sound waves. Of course, playing back 32 channels at different pitches tends to complicate matters, but this is basically how it works.

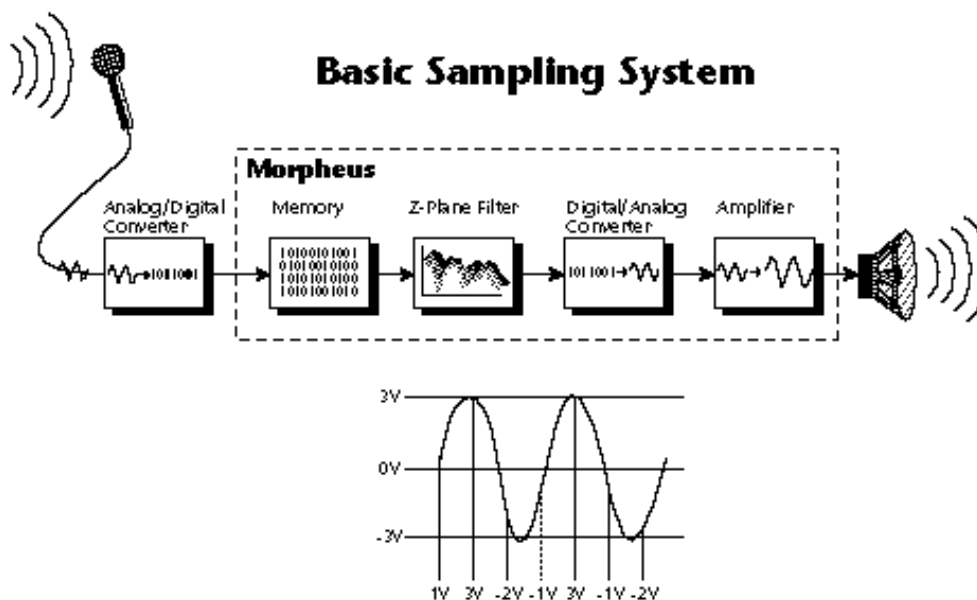

BASIC OPERATION



Volume Control

This is the master volume control for all audio outputs. Note: For maximum dynamic range, set this control at full level.

Card Slot

The card slot accepts RAM and ROM cards containing additional presets, hyperpresets and midimaps.

Master Menu Select Button

The Master menu contains global parameters which affect the entire machine. The LED to the left of the button indicates that you are in the Master menu.

Midimap Menu Select Button

A Midimap is a set of parameters used to configure Morpheus to other MIDI gear such as a sequencer or keyboard setup. The 16 Midimaps contain digital effects setting as well as assignments of presets/hyperpresets to MIDI channels. An LED to the left of the button indicates that you are working in the Midimap menu.

Preset Menu Select Button

The Preset menu is used when you want to create or modify a preset. The LED to the left of the button indicates that you are working in the Preset menu. To Compare an edited preset with the unedited version, simply exit Preset Edit mode. The stored preset will be heard whenever the main screen is selected. Changing the preset will erase the edited version.

Hyperpreset Menu Select Button

The Hyperpreset menu is used to place presets at certain locations on the keyboard to create custom keyboard layouts. The LED to the left of the button indicates that you are working in the Hyperpreset menu.

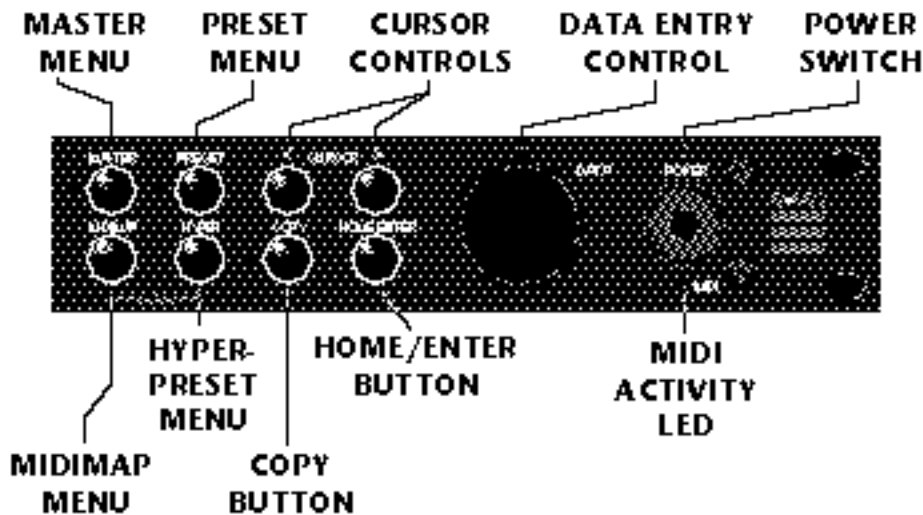

Demo Sequence Select

Morpheus contains four play-only sequences to demonstrate the range of sounds. Press and hold the Midimap and the Hyperpreset buttons simultaneously to select the Demo Sequence selection screen.

▼ You must hold the Midimap and Hyperpreset buttons for approximately two seconds to start the demo sequences.

Cursor Control

These buttons move the cursor to the next parameter on the display in a clockwise or counter-clockwise direction. (The cursor is the little flashing line underneath one of the parameters in the display.) Press either cursor control button repeatedly until the cursor is underneath the desired parameter.

Copy Button

The copy menu allows you to copy selected groups of parameters between Presets, Hyperpresets, and Midimaps.

Home/Enter Button

The Home/Enter button is used to confirm a particular operation or to return the cursor the “Home” position in the upper left corner. The LED flashes to indicate that Morpheus is waiting for your response.

Data Entry Control

The data entry control is a stepped, variable control which is used to change parameter values. The control increments or decrements the current value one unit with each click. This control incorporates acceleration (values advance faster if the control is turned quickly).

••• The cursor can also be moved bidirectionally using the data entry control while the right cursor button is held down. (i.e. Press and hold the cursor button and turn the data entry knob.)

Power Switch

Switches AC power to Morpheus On and Off.

• • If Morpheus is not responding properly or plays the wrong preset, make sure that both Morpheus and your MIDI controller are set to the same MIDI channel and that the MIDI Volume is turned up.

For more information about MIDI, see MIDI Realtime controls on page 97.

Bank	Contents
0	- RAM Presets
1	- ROM Presets
2	- RAM Hyperpresets
3	- Card Presets
4	- Card Hyperpresets

• • Channel Pan should normally be set to "P" unless realtime control of panning is desired. If Pan is set to "0", a stereo preset will play in mono.

MIDI Activity LED

Indicates that MIDI data is being received.

MIDI CHANNEL SELECTION

Press the cursor key repeatedly until the cursor is underneath the channel number. (The cursor is the little flashing line underneath one of the parameters in the display.) Rotate the data entry control to select MIDI channel 01-16. As the channel is changed, the display will change to show the preset/hyperpreset, volume and pan associated with the displayed channel.

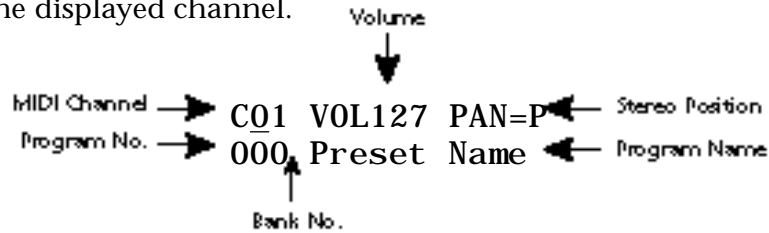

PRESET/HYPERPRESET (PROGRAM) SELECTION

Press the cursor key repeatedly (or press Home/Enter) until the cursor is underneath the program number. A Program is a Preset or a Hyperpreset. As the data entry control is rotated, the program number and name will change. The displayed program will be assigned to the displayed MIDI channel. Programs are arranged into banks of 128, as shown in the diagram at left. Banks can be selected independently of the program number by pressing the Home/Enter button while turning the data entry knob.

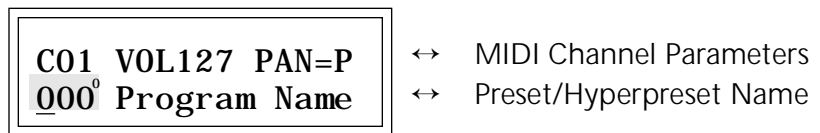

CHANNEL VOLUME

Press the cursor key repeatedly until the cursor is underneath the volume value. Rotate the data entry control to select volume 000-127. (This is the same parameter as MIDI volume control #7, and changes made over MIDI will be shown in the display.)

CHANNEL PAN

Press the cursor key repeatedly until the cursor is underneath the pan value. Rotate the data entry control to select pan values -7 to +7 or "P". When "P" is selected, the pan value specified in the preset is selected. Any other value will override the pan parameter in the preset. (This is the same parameter as MIDI pan control #10, and changes made over MIDI will be shown in the display.)

MEMORY CARD

The memory card is a convenient method of saving and transferring presets and hyperpresets. Insert the card firmly into the slot on the front panel with the label facing up. Press the eject button to release the card. A RAM card stores 128 presets, 128 hyperpresets and 16 midimaps. RAM cards may be Write-Protected by moving the little switch on the end of the card. If a memory card is NOT inserted, the display reads “ --noCard-- ” for banks 3 & 4 and the list of selectable midimaps shrinks to 16.

MIDIMAP SELECTION

A Midimap is a set of parameters which can be used as a pre-sequence setup, storing the program and other parameters for each MIDI channel or it could be used as an “Effects Preset”, since each Midimap stores a complete effects setup. There are 16 Midimaps in Morpheus and an additional 16 Midimaps can be stored on a memory card.

To Select a Midimap

Press the Midimap key, lighting the LED. The current screen will be the one most recently selected since powering up Morpheus. The first screen in the menu is Midimap Select. Move the cursor to the lower line and use the data entry control to select one of the 16 Midimaps. The Home/Enter LED will be flashing. Press the Home/Enter key to load the new Midimap.

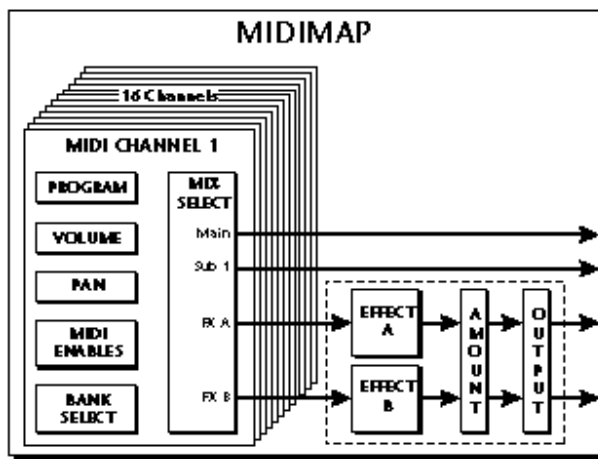

Simply scrolling through the list DOES NOT change the Midimap. You must move the cursor down to line two and press Enter. Try out the different Midimaps and notice that the effects change with each one.

RAM Cards can be used to store your own presets, hyperpresets and midimaps.

ROM Cards contain pre-recorded presets, hyperpresets and midimaps. You cannot save data to a ROM card.

▼ RAM Cards need to be initialized before they are first used. They display will prompt you to initialize a blank card.

••• The “current Midimap” is remembered on power-down, even though you may not have saved it. This effectively gives you a total of 17 internal Midimaps.

MULTI-TIMBRAL OPERATION

Multi-timbral operation means that the Morpheus can play more than one sound at the same time. To access multiple presets on different MIDI channels simultaneously, follow these instructions:

1. Set the MIDI mode to MULTI-Mode, using the MIDI mode function in the Master menu (page 22).
2. Decide which MIDI channels you wish the Morpheus to receive, and turn “All Messages” Off for the MIDI channels that you DO NOT want Morpheus to receive using the MIDI Enables in the Midimap menu (page 33). Turning “All Messages Off” turns that channel Off.

If you do not turn any channels Off, Morpheus will receive all 16 MIDI channels simultaneously!

3. Select the desired preset or hyperpreset for each of the MIDI channels you wish the Morpheus to receive using the Preset/Hyperpreset -> MIDI Channel selection screen in the Midimap menu (page 31).
4. Save the Midimap using the last screen in the Midimap menu.
5. Morpheus will now respond multi-timbrally on the MIDI channels you have specified.
6. The effects can be programmed and each MIDI channel assigned to an effects bus if so desired. The volume and pan position can be adjusted for each MIDI channel in the Midimap Volume and Pan screen. Remember to SAVE the Midimap or all of your work will be LOST when you select another Midimap.

PLAYING THE DEMO SEQUENCES

Morpheus contains a play-only sequencer with 4 different sequences to give you an idea of what is possible using this amazing instrument. Press and hold both the Midimap and Hyper buttons. The sequence will start momentarily. Press the Enter button to stop the sequence. Press the right cursor button to advance to the next sequence. Sequences will cycle automatically.

DEMO 1 2 3 4
ENTER=Stop >=Nxt

**MASTER
MENU**

The Master menu contains functions that affect the overall operation of Morpheus. For example, changing the Master Tune will change the tuning of all the presets, not just the one currently displayed.

To enable the Master menu

Press the Master button, lighting the LED. The current screen will be the one most recently selected since powering up Morpheus. The Cursor will appear underneath the first character of the screen heading on line one.

To select a new screen

Press the Home/Enter button or press the Cursor button repeatedly until the cursor is underneath the screen title heading. Rotate the data entry control to select another screen.

To modify a parameter

Press the Cursor button repeatedly (or hold the right cursor key while turning the data entry control) until the cursor is underneath the parameter value. Rotate the data entry control to change the value.

To return to the main screen

Press the Master button, turning off the LED.

MASTER MENU FUNCTIONS

- Master Tune

Master tune adjusts the overall tuning of all presets so that Morpheus can be tuned to other instruments. The master tuning range is ± 1 semitone in 1/64th semitone increments. A master tune setting of “+00” would indicate that the Morpheus is perfectly tuned to concert pitch (A=440 Hz).

MASTER TUNE
+63

- Transpose

This function transposes the key of Morpheus in half-step intervals. The transpose range is ± 12 semitones or one octave.

TRANSPOSE
+12 semi tones

•• Application: The user key tuning can be used to tune individual percussion instruments.

▮ It is possible to tune the pitch so high that the range of Morpheus' pitch shifter is exceeded. If the pitch will not go any higher, try using the Transpose control instead of Coarse tuning.

•• In order for the Pitch Wheel to control pitch, it must be routed to this destination in the Realtime Modulation Control screen.

• User Key Tuning

In addition to standard twelve tone equal temperament, Morpheus contains four additional preset tuning tables (Just C, Vallotti, 19 tone, and Gamelan) and one user definable tuning. User Key Tuning allows you to alter the parameters of the user definable tuning stored in memory. The initial frequency of every key can be individually tuned, facilitating the creation of microtonal scales. Using the cursor key and the data entry control, select the key name, the MIDI key number and the fine tuning. The key name is variable from C-2 to G8. Coarse Tuning (which also happens to be the MIDI key number) is variable from 0 to 127. The fine tuning is variable from 00 to 63 in increments of 1/64 of a semitone (approx. 1.56 cents). For each preset, the specific tuning table is selected in the Preset menu.



• Global Bend

This function sets the range of the pitch wheel controller (even when pitch wheel is not routed to control pitch). The maximum pitch bend range is ± 12 semitones. This function only affects presets which have their individual pitch bend range set to global.

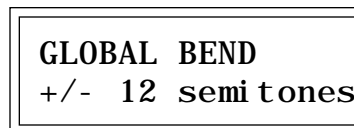

• Global Velocity Curve

Incoming velocity data can be modified by a velocity curve in order to provide different types of dynamics in response to your playing or to better adapt to a MIDI controller. This function allows you to select one of eight global velocity curves or leave the velocity data unaltered (off). Global velocity curve only affects presets which have their individual velocity curve set to global.

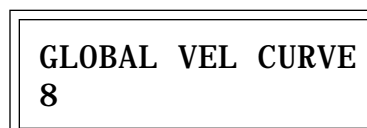

GLOBAL VELOCITY CURVES

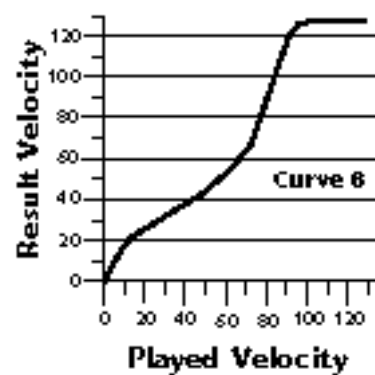
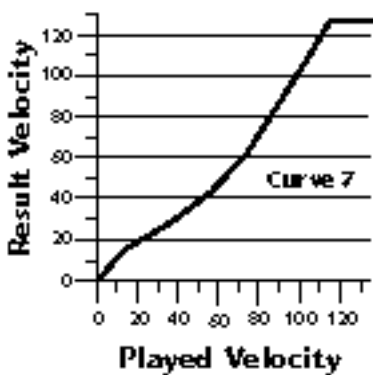
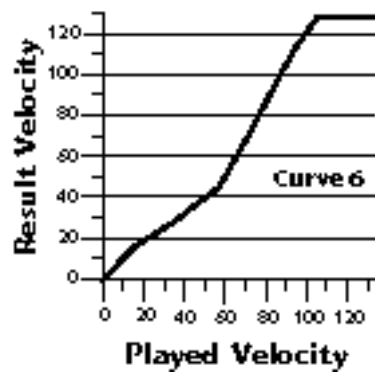
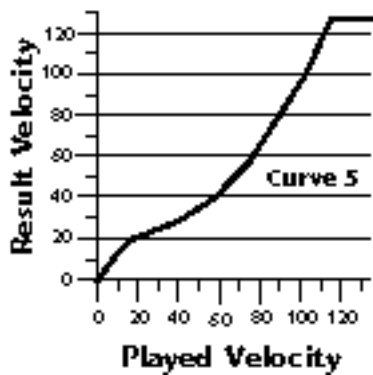
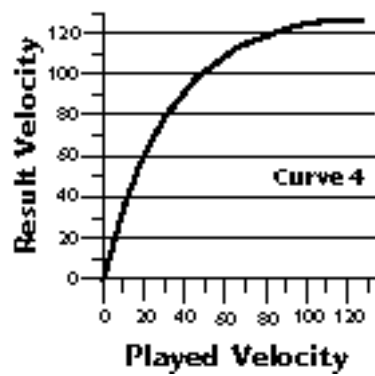
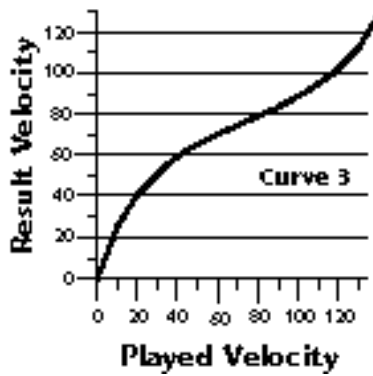
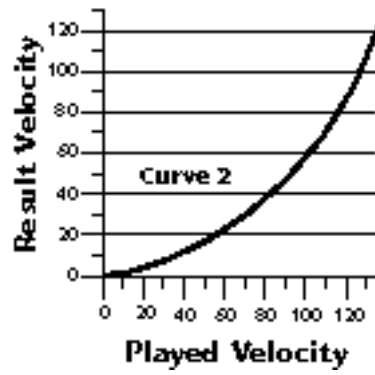
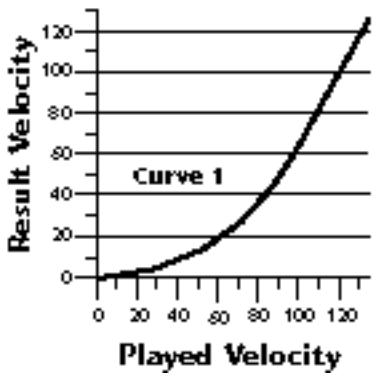

- MIDI Mode

This function selects one of the four MIDI receive modes and the MIDI system exclusive ID number.

Omni mode

Morpheus responds to note information on all MIDI channels and plays the preset currently displayed in the main screen.

Poly mode

Morpheus only responds to note information received on the currently selected MIDI channel (the “basic channel”, displayed on the main screen) and plays that channel’s associated preset.

Multi mode

Morpheus responds to data on any combination of MIDI channels and plays the specific preset associated with each of the MIDI channels.

Mono mode

Morpheus responds to data on any combination of MIDI channels but plays each channel monophonically. If a new note on a channel is played before the last note is released, the envelopes will not be retriggered. Mono mode is particularly useful with alternate controllers such as MIDI guitars, etc.

Device ID

This function allows an external programming unit to distinguish between multiple Morpheus units. In the case of multiple Morpheus units, each unit should have a different device ID number.

MIDI MODE	ID
Omni	00

- MIDI Mode Change

This function selects whether or not MIDI mode change commands are accepted or ignored when received over MIDI (see MIDI Mode).

MIDI MODE CHANGE
Disabled

Warning: MIDI Sysex data will not be transferred between two Morpheus units unless the ID numbers of both units match.

• MIDI Program Change Map

Incoming MIDI program changes can be remapped to a different numbered preset. This is a handy feature when you want a specific MIDI program number sent from the master synth to be linked with a specific preset or hyperpreset on Morpheus. For example, the Program Change Map could be set to call up preset 12 whenever Morpheus receives program change number 26. Any preset or hyperpreset in Morpheus can be mapped to any incoming MIDI program change number. There are four separate Program Change Maps available. This feature also allows you to call up presets in any bank, which are not accessible through a standard MIDI program change. Note: The Program Map only operates if it is selected in the Midimap and if the Bank Select function in the Midimap is set to bank 0.

PROG CHG MAP #1
026 > 012

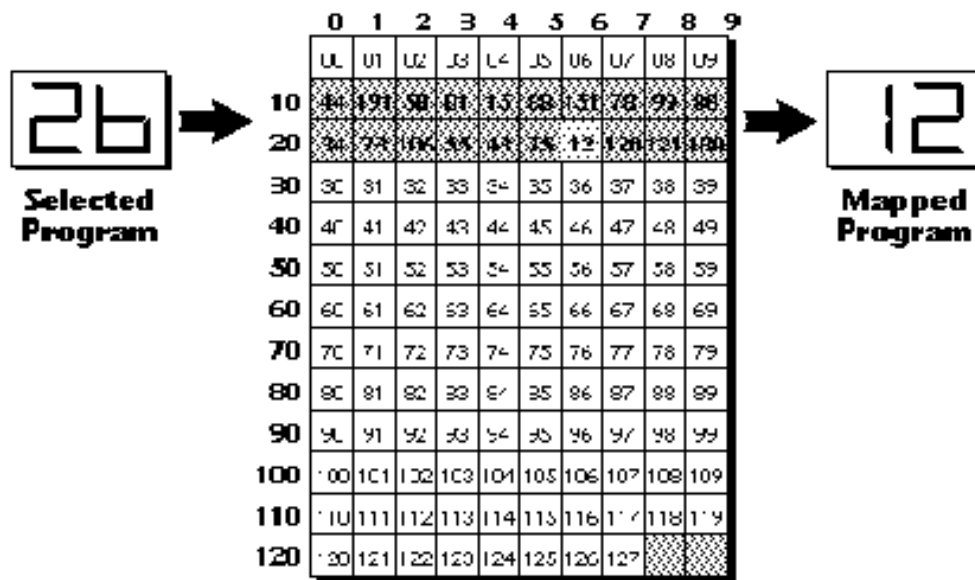

This chart shows how MIDI preset changes can be re-mapped. In this example, program changes 10-29 have been re-mapped. All other programs will be selected normally.

••• The Bank Select function is located in the Midimap menu.

••• On some synthesizer Program 00 is called Program 01 with a corresponding difference through all the numbers.

MASTER MENU

•• A few of the standardized MIDI Controller numbers are listed below.

- Modulation Wheel or Lever
- Breath Controller
- Aftertouch: Rev 1 DX7
- Foot Pedal
- Portamento Time
- Data Entry
- Volume
- Balance
- Undefined
- 0 - Pan
- 1 - Expression

•• A few of the standardized MIDI switch numbers are listed below.

- 4 - Sustain Switch (on/off)
- 5 - Portamento (on/off)
- 6 - Sostenuto (on/off)
- 7 - Soft Pedal (on/off)
- 9 - Hold Pedal 2 (on/off)

⚠ Warning: When transferring Sysex data from one Morpheus to another, the ID numbers of both units must match.

• MIDI Controller Assign

Morpheus allows you to assign up to four realtime control sources from your MIDI controller. These control sources could be modulation wheels, data sliders or whatever. In this screen, you set up which controllers will be received by the Morpheus. What effect the controller will have is programmed separately for each preset. The Morpheus MIDI controllers are each assigned a letter, A-D. Each controller letter can be assigned to a MIDI realtime controller from 00-31. Note: If controller numbers 7 or 10 are selected, they will override the standard MIDI volume and pan control routings. For more information, see MIDI Realtime Controls in the Programming Basics section.

CONTROLLER#	A	B	C	D
01	02	03	04	

• MIDI Footswitch Control

Like the MIDI Controllers, 3 MIDI footswitches can be assigned to MIDI footswitch numbers. Footswitches can be assigned numbers from 64-79. Destinations for the footswitch controllers are programmed in the Preset menu.

FOOTSW	CTL#	1	2	3
64	65	66		

• Send MIDI Data

This function will send MIDI System Exclusive data to the MIDI Out port of Morpheus. The MIDI data can either be sent to a computer/sequencer or to another Morpheus. Using the cursor key and the data entry control, select the type of MIDI data you wish to transmit.

SEND MIDI DATA
RAM Presets

The Enter LED will be flashing. Press the Enter button to confirm the operation. To receive MIDI data, simply send the MIDI data into Morpheus from another Morpheus or your sequencer. The choices are:

- RAM Presets **Transmits all the user RAM presets.**
- ROM Presets **Transmits all the factory ROM presets.**
- Card Presets **Transmits all the memory card presets.**
- RAM Hypers **Transmits all the user RAM hyperpresets.**
- Card Hypers..... **Transmits all the memory card hyperpresets.**
- RAM MIDI Maps **Transmits all the user MIDI maps.**
- Card MIDI Maps **Transmits all the memory card MIDI maps.**
- Program Change Maps **Transmits all the program change maps.**
- Master Settings **Transmits all parameters in the Master menu except tuning table, program change map & viewing angle. The “scratch” Midimap is also transmitted.**
- Tuning Table **Transmits only the user tuning table.**
- All RAM Data **Transmits all the user RAM data in the machine.**
- Individual Program ... **Transmits only the specified preset or hyperpreset.**
- Individual Midimap..... **Transmits only the specified midimap.**
- Individual Program Change Map **Transmits the specified program map.**

When Individual Programs, Midimaps or Program Change Maps are received via SysEx, they are placed in their proper locations.

• Sysex Packet Delay

Errors can sometimes occur when transferring Sysex data from Morpheus to a computer because the computer cannot process and store the incoming data fast enough. This function allows you to change the amount of delay between MIDI Sysex data packets so that the input buffer of your computer does not overflow. The default speed is 300 delay units. A setting of “000” allows full speed MIDI Sysex. If you are having data transmission errors, increase the delay until the problem disappears.



To Record MIDI Data into a Sequencer:

1. Setup sequencer to receive system exclusive data.
2. Place sequencer into record mode, then Send MIDI Data.

To Receive MIDI Data from a Sequencer:

1. Simply play back the sequence into Morpheus.

▼ Warning: Send data from your sequencer as you would a regular sequence. Sending data in one huge chunk may clog the Morpheus input buffer.

▼ A Midimap received by Morpheus does not change the “scratch” Midimap unless it is currently selected. You must select the Midimap for it to be active. See page 159.

••• The Individual Midimap and Program Change Maps are located after the Individual Programs (keep scrolling).

▼ Turn “Keyboard Thru” mode OFF on your sequencer when transferring SysEx data or a MIDI feedback loop may result.

- Proteus Sysex

When this function is On, Proteus presets can be transferred over MIDI into Morpheus. It also allows the use of Proteus patch editing programs. Instrument numbers and parameters which are unique to Morpheus will, of course, NOT be transferred. This function defaults to Off to avoid unplanned conflicts with Proteus Sysex transfers.

PROTEUS SYSEX
Off

- Auto Select

When editing a parameter which involves the keyboard, such as a zone range, the parameter can be automatically selected simply by playing the keyboard. This is a handy feature for “power programmers”, but can sometimes be confusing. Therefore, Auto-Select can be turned On or Off. Auto-Select affects the following parameters: User Key Tuning, Zone Select, Key Range, Midimap, Preset & Hyperpreset Naming, Cross-switch Point, Keyboard Center.

AUTO- SELECT
Off

- Compare

This function turns the Compare feature (accessed by pressing the Preset button when editing) On or Off. If Compare is turned On, changes made via MIDI SysEx will not be heard except when the Preset menu is enabled.

COMPARE
On

- Viewing Angle

This function allows you to change the viewing angle of the display so that it may be easily read from either above or below. The angle is adjustable from +7 to -8. Positive values will make the display easier to read when viewed from above. Negative values make the display easier to read from below.

VIEWING ANGLE
+7

▮ If Morpheus does not respond to external preset editors, turn the Compare function Off.



MIDIMAP MENU

THE MIDIMAP

A Midimap is a group of parameters which you might associate with a specific sequence or song. You can also use the Midimaps as “Effects Presets” for your favorite effects setups. The Midimap contains all the pre-sequence setup information, such as the program (preset or hyperpreset) for each MIDI channel, effects settings, etc. There are 16 Midimaps in Morpheus and an additional 16 can be stored on a memo

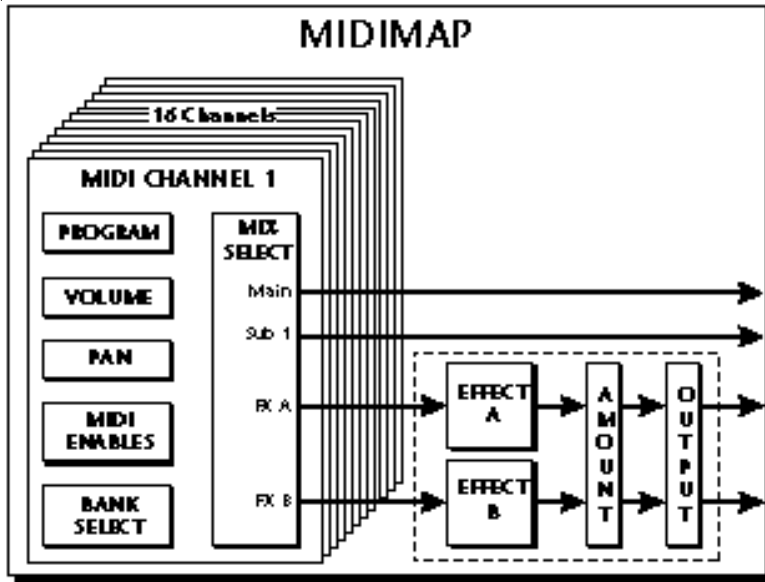

••• Midimaps can also be changed using a SysEx Parameter Change command. See page 159.

Midimaps are often used with Morpheus connected to an external sequencer in MULTI mode. Multi mode allows Morpheus to receive MIDI data on all 16 channels simultaneously. Morpheus can store 16 different Midimaps. The two digital effects processors are also part of the Midimap.

MIDI Map	
MIDI Map Name	12 Characters
Program _____	for 16 MIDI Channels
Volume _____	for 16 MIDI Channels
Pan _____	for 16 MIDI Channels
Mix Select _____	for 16 MIDI Channels
MIDI Enables _____	for 16 MIDI Channels
Bank Select _____	for 16 MIDI Channels
Program Change Map	Off, 1-4
Effect A	Effect Select & Parameters
Effect B	Effect Select & Parameters
Effect Amount	Wet/Dry Mix, A->B Amount
Effect Output Select	Main, Sub 1, Sub 2

▸ Selecting a new Midimap will overwrite the "current" or "scratch" Midimap.

To enable the Midimap menu

Press the Midimap button, lighting the LED. The current screen will be the one most recently selected since powering up Morpheus. The cursor will appear underneath the first character of the screen heading on line one.

To select a Midimap

Press the Home/Enter button or press the cursor key repeatedly until the cursor is underneath the screen title heading. The first screen in the list is "Midimap Select". Move the cursor to the lower line of the display and use the data entry control to select the desired Midimap. The Home/Enter LED will be flashing. Press Home/Enter to load the Midimap.

To select a new screen

Press the Home/Enter button or press the cursor key repeatedly until the cursor is underneath the screen title heading. Rotate the data entry control to select another screen.

To modify a parameter

Press the cursor button repeatedly (or hold the cursor key while turning the data entry control) until the cursor is underneath the parameter value. Rotate the data entry control to change the value.

To return to Program Select mode

Press the Midimap button, turning off the LED.

MIDIMAP MENU FUNCTIONS

- Midimap Select

This is where you select one of the 16 Midimaps. You can use the Midimaps to setup a particular sequence or song. Position the cursor under the Midimap number and use the data entry control to select the Midimap. The Home/Enter LED will be flashing. You MUST press Enter to load the Midimap.

MIDIMAP SELECT
MOO Cool FX

• Midimap Name

This function allows you to name each of the 16 Midimaps with a name of up to 12 characters. Position the cursor underneath the character location and use the data entry control to change the character. The keyboard can also be used to select characters.

This screen displays the current Midimap. The Midimap Select screen is the last screen in the menu.

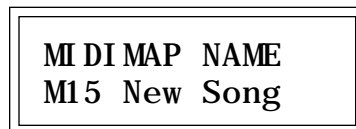

• Preset/Hyper to MIDI Channel Assign

This function allows you to assign a preset or hyperpreset (program) to each MIDI channel for the currently selected Midimap.

Position the cursor under the channel number and use the data entry control to change the MIDI channel. Position the cursor under the program number and use the data entry control to change the program assigned to each MIDI channel.



• Volume, Pan & Output Mix

This function sets the Volume, Pan Position and Output Mix for each MIDI channel in the selected Midimap. Volume allows you to adjust the relative volume between programs. Pan allows you to position each program in the stereo field. The Volume control acts as an attenuator on the program volume. It cannot increase the volume past the setting programmed in the program.

▼ The Pan control Overrides the pan value programmed in the program.

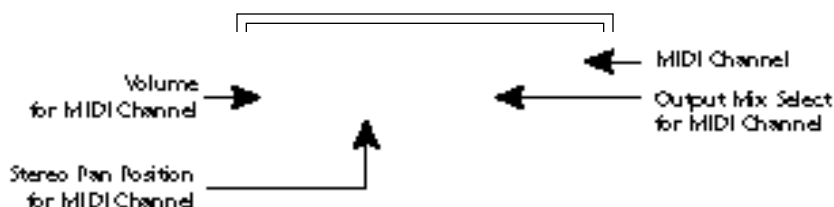

▼ The Auto-Select feature in the Master menu must be turned On in order to use the keyboard for naming Midimaps.

▼ The MIDI channel shown in the right side of the screen is NOT the MIDI basic channel, only the one being edited in the Midimap.

••• Channel Pan should normally be set to "P" unless realtime control of panning is desired. If Pan is set to "0", stereo preset will play in mono.

The Output Mix allows you to selectively route the program through one of the effects processors or direct it to a pair of output jacks (for each of the 16 MIDI channels). An additional selection called Preset or "P", allows the selection to be made in the preset (Mix Output). Thus effects and outputs can be selected according to MIDI channel or by preset.

Position the cursor under the channel number and use the data entry control to change the MIDI channel. Position the cursor under the volume, pan or mix and use the data entry control to change the value. The volume and pan values are the same ones shown in the main screen.

The diagram below shows the function of Output Mix Select.

•• Please note that the Sub Output is an "Effects Only" output.

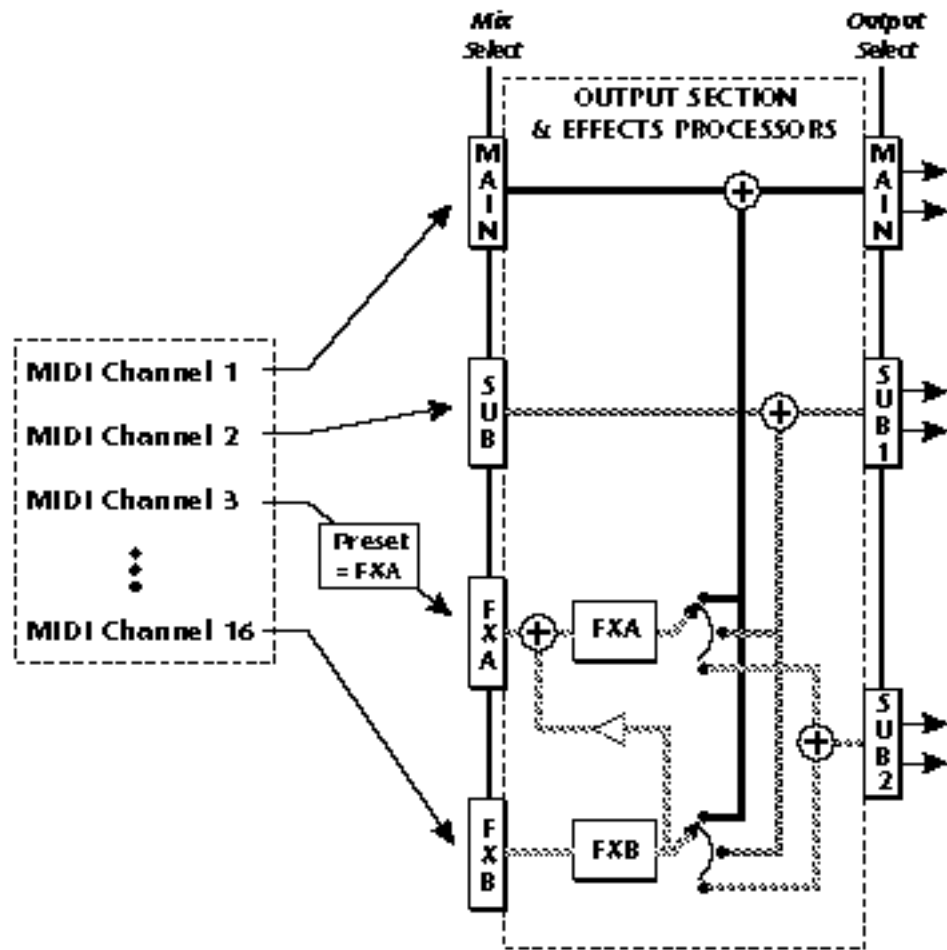

The Output Mix Select (for each MIDI channel) selects which bus in the Output Section will be used.

• MIDI Enables

The MIDI enables allow you to enable or filter out specific MIDI messages on a per-channel basis. MIDI messages that can be filtered include:

All Messages (turns channel off)	Pitch Wheel
Program Change	Mono Pressure
Bank Select	Key Pressure
Volume Control (controller #7)	Controllers A-D
Pan Control (controller #10)	Footswitches 1-3

••• The Channel Pan control can be disabled to prevent incoming MIDI messages from altering stereo effects programmed in the presets.

The “All Messages” filter is useful when you have other MIDI devices connected and do not want Morpheus to respond to the MIDI channels reserved for other devices. Messages will be passed when On and filtered out when turned Off.

MIDI ENABLES C01
All Messages On

• Bank Select

The MIDI specification only allows for 128 presets per MIDI channel. This function selects which bank of 128 presets will be used for incoming MIDI program change commands. Banks can be set for each MIDI channel. This function allows you to access all presets and hyperpresets in Morpheus without using a MIDI Bank Select command.

BANK SELECT C01
0

MIDI Chan.	Bank#	Type
Channel 1	Bank 0	RAM Presets
Channel 2	Bank 2	RAM Hyperpresets
Channel 3	Bank 1	ROM Presets
♦	♦	♦
♦	♦	♦
♦	♦	♦
Channel 16	Bank 0	RAM Presets

•• The Program Change Maps are located in the Master menu.

• Program Map Select

There are four Program Maps in Morpheus. Program Maps allow incoming MIDI program changes to be translated into another number. For example, a program map could be set up so that program number 12 is selected whenever program change number 26 is received at the MIDI in port. The Program Map Select function allows you to select one of the four Program Maps to be used in the currently selected Midimap or turn the Program Map function Off. Note: The Program Map only operates if it is turned On and the Bank Select function is set to bank 0.

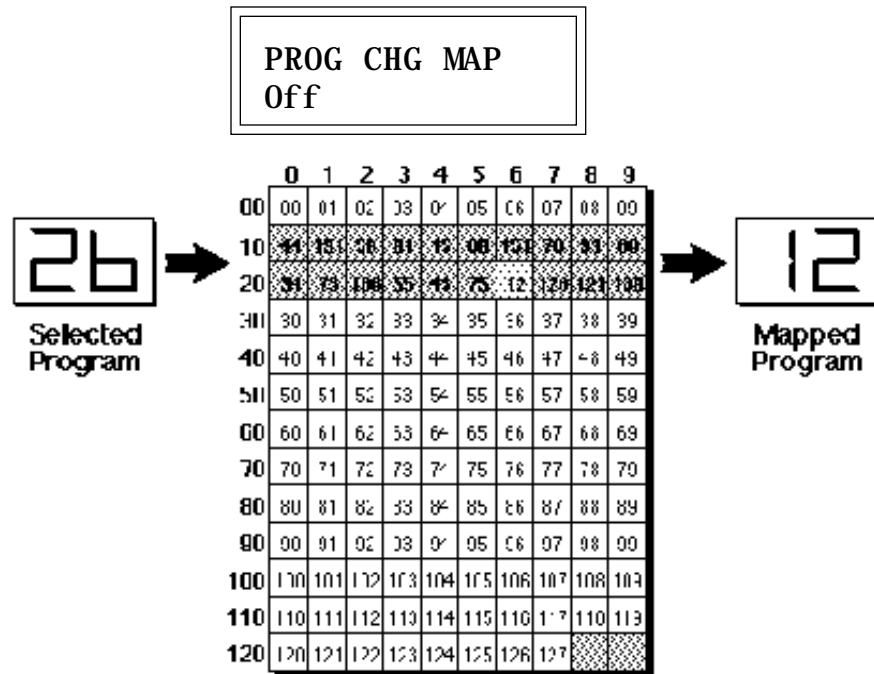

This chart shows how MIDI preset changes can be re-mapped. In this example program changes 10-29 (darkened area) have been re-mapped. All other programs will be selected normally.

• FX A

This function allows you to select which effect is active on Effect Processor A. Processor A effects include several types of reverb as well as other effects such as delays, chorus, flanger, and phase shifter. Each effect has one or more adjustable parameters which are accessed by moving the cursor to the lower line. See the Effects section for detailed information on these functions.

FXA: Room
Decay Time 100

- FX B

This function allows you to select which effect is active on Effect Processor B. Processor B effects include echo, delay, chorus, phase shifter, distortion and ring modulator. Each effect has one or more adjustable parameters which are accessed by moving the cursor to the lower line. See the Effects section for detailed information on these functions.

FXB: StereoFlange	
LFO Rate	050

- FX Amount

This function allows you to adjust the ratio of dry (unprocessed) to wet (processed) signal coming out of the effect processor. A setting of 100% indicates that all of the signal is being processed by the effect. The B->A parameter allows you to adjust the amount of effect B which will be fed through the A effect. If B->A is set to one value above 100%, the word "Only" is displayed and the B amount changes to Off. This disconnects effect B from the main outputs and routes ALL of effect B through effect A.

FX AMOUNT A: 50%	
B->A: 0%	B: 75%

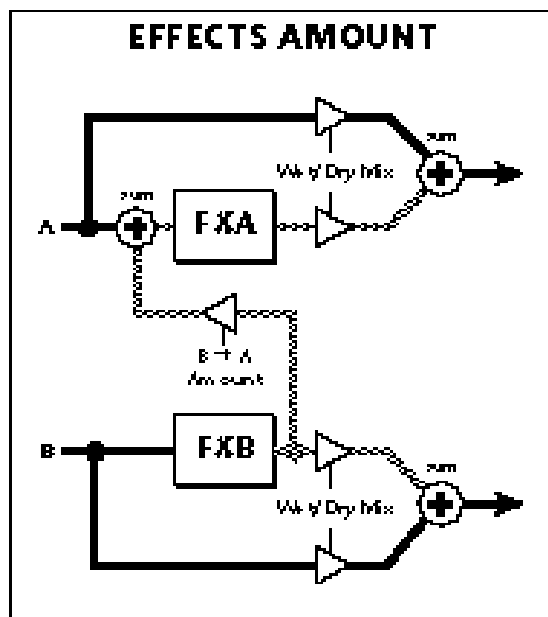

▼ If the B->A amount is set to "Only", no sound will result if "No Effect" is selected for effect A

- FX Output Select

This function selects which pair of output jacks each effect processor will be routed. This is shown in the diagram on page 32 by the 3-way switches after each effect processor.

FX OUTPUT SELECT
A: Main B: Sub 1

- Save Midimap

Changes made to a Midimap are not made permanent until the Midimap is Saved. To save a Midimap, move the cursor to the bottom line and select one of the 16 locations with the data entry control. The Enter LED will be flashing. Pressing the Home/Enter switch will confirm the operation. Writing to a Midimap location erases the existing Midimap in that location. Make sure that the location does not contain information you want to keep.

Save MIDI MAP to
MOO - defMIDI Map-

EFFECTS
SECTION

Where are the Effects?

The effects in Morpheus are separate from the preset. This is similar to an external effects unit except that the signal path is kept in the digital domain to maintain excellent sound quality.

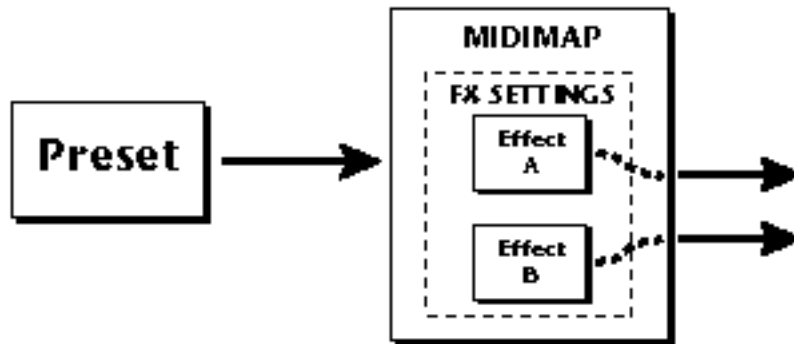

The Effects section in Morpheus is located external to the preset in the Midimap menu.

The effects section is located within the Midimap. There are 16 Midimaps (and 16 more on a memory card) which store different effects setups. You could think of a Midimap as an Effects Preset (although they store other parameters as well).

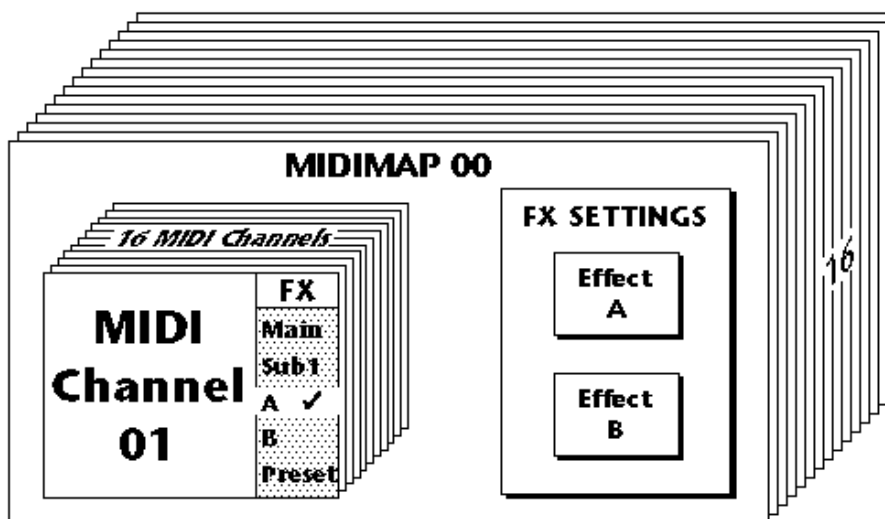

For each of the 16 MIDI channels, you may select: Effect A, Effect B, the Main Outputs (with no effect), the Sub 1 Output (with no effect), or you may choose to use the Mix Select programmed as part of the preset. Therefore you can select effects routings by MIDI channel or by preset. The choice is up to you.

EFFECTS OUTPUT ROUTING

The diagram below shows how the effects section is integrated into the output jack routing scheme. The mix bus can be selected either by the preset or by MIDI channel. When “Preset” is selected, the MIX SELECT programmed in the preset is used.

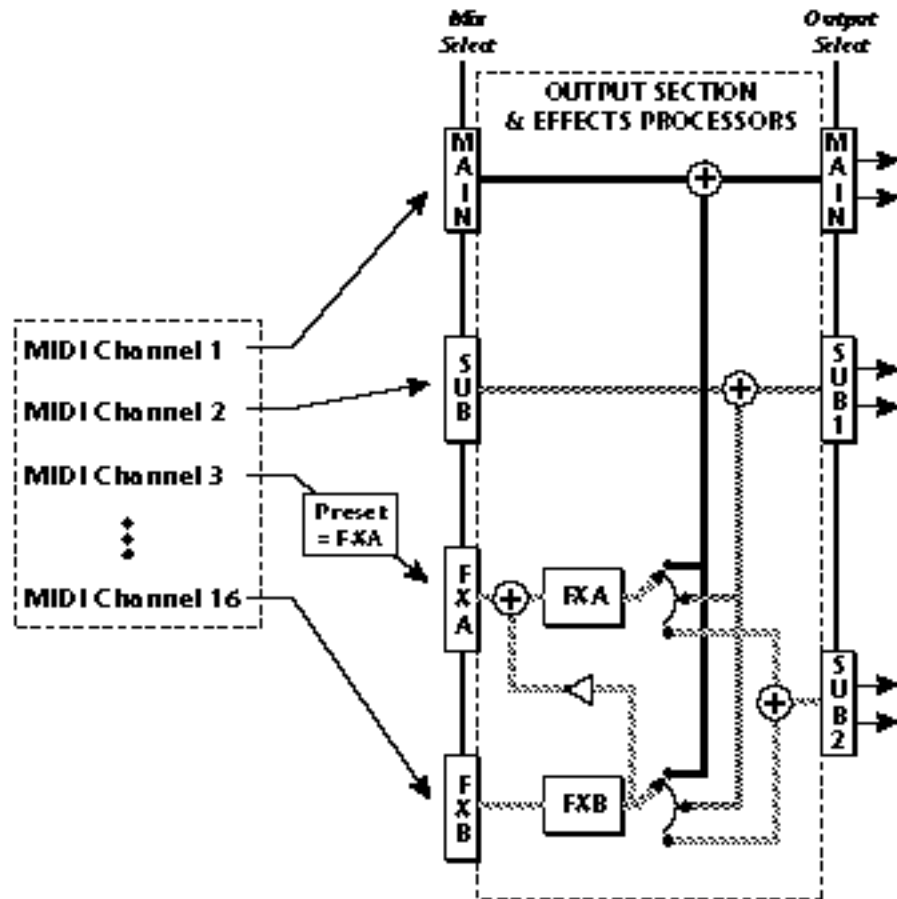

MORPHEUS EFFECT BUS ARCHITECTURE

The two stereo effect processors on Morpheus are designated as A and B effects. “A” effects contain Reverb and other effects. The “B” effects do not include Reverbs, but include a host of other great effects which are listed on page 53.

Each effect has its own set of control parameters which are appropriate to that particular effect. For both the A and B effects there is an amount parameter which determines the relative mix of the processed and unprocessed signals (wet/dry mix). The output of the B effect can also be routed back through processor A. In addition, the stereo submix outputs (Sub 1) can be used to externally process selected presets.

TO PROGRAM AN EFFECT:

- 1) Press the MIDIMAP button lighting the LED.
- 2) Slowly turn the data entry knob clockwise until you find the screen shown below. Select one of the effect processors in the Mix Selection. This selects the input to the effect processors.

```
VOL PAN MIX C01
127 =P FXA
```

- 3) Set the FX Amount for the A or B effect. This adjusts the ratio of effected to un-effected signal. B->A allows you to route the output of effect B through effect A (set the MIX to effect B).

```
FX AMOUNT A: 50%
B->A: 0% B: 50%
```

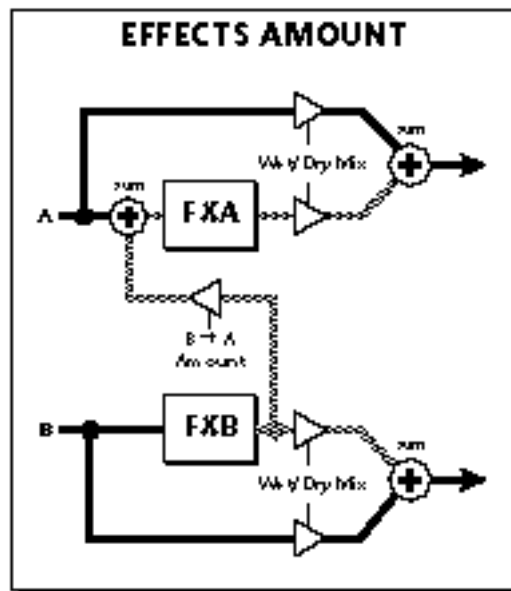

- 4) Select the desired Effect and program the appropriate parameters.

```
FXA: Echo
L Delay Time 255
```

••• The diagram on the previous page illustrates the function of Mix Select.

••• Setting the B->A percentage to maximum selects "Only" which disconnects effect B from the main outputs and routes all of the signal through effect A.

▼ If the B->A amount is set to "Only", no sound will result if "No Effect" is selected for effect A

A EFFECTS

- Room
- Warm Room
- Small Rooms 1 & 2
- Halls 1, 2 & 3
- Chambers 1 & 2
- Plates 1 & 2
- Early Reflections 1-4
- Reverse Early Refl.
- Rain & Shimmer
- Stereo Flange
- Phaser
- Stereo Chorus
- Delay
- Cross Delay
- Echo

B EFFECTS

- Fuzz
- Fuzz Lite
- Stereo Flange
- Phaser
- Stereo Chorus
- Delay
- Cross Delay
- Ring Modulator

REVERB

Reverberation is a simulation of a natural space such as a room or hall. The reverb effects in Morpheus simulate various halls, chambers, rooms and reverberation plates. In addition, there are several other reverb effects such as Early Reflections and Rain. There is only one adjustable parameter on the reverbs - Decay Time. Decay time is the length of time that it takes for the reflected sound from the walls of the room to die away. In general, the larger the room, the longer the decay time.

The diagram below breaks down the reverberated sound into its component parts. After an initial pre-delay period, the echoes from the closest walls or ceiling are heard. These first echoes or the early reflection cluster, vary greatly depending on the type of room. Roughly 20 milliseconds after the reflection cluster, the actual reverberation begins and decays according to the time set by the decay time parameter.

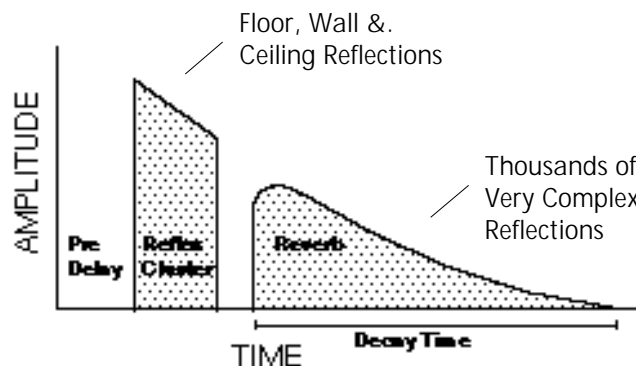

Room programs simulate small rooms with high frequency absorption caused by drapes and furniture.

Plates simulate plate type reverbs with their tight, dense early reflections and sharp reverb build-up.

Chambers simulate medium sized rooms with hard reflective surfaces.

Hall programs recreate the open, spacious ambience of large concert halls.

Early Reflection programs consist of the reflection cluster only without the reverb decay. These effects are similar to a multiple tap delay line and have a single adjustable parameter - Ambience.

The special reverbs Rain & Shimmer are variations of the early reflection programs and consist of a dense group of short echoes followed by longer echoes.

<p>FXA: <u>H</u>all 1 Decay Time: 165</p>
--

Place the cursor underneath the reverb name and use the data entry control to change the type of reverb. Moving the cursor to the lower line allows you to change the decay time of the reverb. The decay times of the reverb programs range from 100-255. The ambience control of the Early Reflection programs range from 0-100.

- Room

A bright, medium sized room. The apparent source position is fairly close to the listener. Suitable for use with 100% wet mix setting for adding ambience.

- Warm Room

This reverb is similar to “Room” with more high frequency absorption, slightly larger size and a more distant source position.

- Small Room 1

This reverb is also to “Room” with shorter initial reflections, shorter decay times and higher reflection density, due to the reduced room size. The apparent source position is closer to the listener.

- Small Room 2

This reverb is a variation of “Small Room 1” with greater high frequency damping and a more distant source position.

- Hall 1

Hall 1 is a large, highly reverberant space with auditorium-like acoustics. Like all the Hall programs, “Hall 1” exhibits a warm, distant ambience with slow reflection density buildup. With the decay parameter set to maximum, “infinite” reverberation effects can be obtained. Adjustment of wet-dry mix can be used to position the listener from the “front row” (25%) to “back of the balcony” (100%).

- Hall 2

This reverb is similar to “Hall 1”, but harder and brighter, with more pronounced slap echoes that come from parallel reflecting surfaces in the room. Hall 2 also exhibits a pronounced reverb “bloom” or late-reflection buildup. A 50% wet mix creates the optimum “close” distance adjustment.

- Hall 3

Hall 3 is similar to “Hall 2”, but with larger scale stadium-like acoustics. Hall 3 is warmer than Hall 2 (more high frequency damping) and does not display the obvious early reflections and slap echoes. It also exhibits a distinct pre-delay of approximately 100 milliseconds and a pronounced late reflection buildup both of which contribute to the impression of a large space. Wet mix values of 10% to 50% are most appropriate, although a setting of 100% produces an effective cave simulation.

- Chamber 1

A simulation of a bright, medium-sized chamber reverb or recital hall with hard walls. Early reflections are very prominent, with high reflection density. Moderately long decays are possible at the maximum decay setting.

- Chamber 2

Similar to “Chamber 1” but with a much warmer sound. The wet mix adjustment provides an effective control over the apparent source location from close (10%) to very distant (100%).

- Plate 1

Simulates a plate reverb unit. Gives a tight, bright, slightly metallic sound. Reflection buildup is very rapid, with high density. Early reflections are minimized.

- Plate 2

An effect similar to Plate 1, but slightly warmer with less density.

EARLY REFLECTION GROUP

All Early Reflection programs have a single Ambience parameter which adds diffusion to the individual reflections. Lower ambience settings cause reflections to become more discrete, simulating harder reflecting surfaces. The early reflection programs are simulations of increasingly large acoustic spaces, from a small studio (Early Refl 1) to a large room like a sound stage (Early Refl 4). The wet mix control acts effectively as source distance control. In general, lower mix amounts are more effective as the room size increases.

- Early Reflection 1
- Early Reflection 2
- Early Reflection 3
- Early Reflection 4

- Reverse Early Reflection

More of a special effect than an acoustic simulation, Reverse ER contains a set of exponentially increasing delay taps, creating a kind of “zip” sound at low Ambience settings. At maximum ambience and lower wet mix values, the sound is more authentically acoustic, with a long, delayed reflection “bloom”. The effect is similar to a large but well damped parking garage.

SPECIAL REVERBS

These special reverbs all have a single Decay Time parameter.

- Rain

Similar to a repeating delay, but with complex spatial and filtering effects occurring across the stereo panorama. The effect on percussive sounds might be likened to a bucket of marbles raining down on a galvanized steel roof.

- Shimmer

Distantly related to the Rain effect, Shimmer causes input signals to be progressively diffused in time and space across the stereo panorama. The spatial diffusion is accompanied by a flanging effect. The program is highly responsive to left or right-panned inputs. A stunning special effect with percussive sounds, and especially through headphones.

- Stereo Flanger

A flanger consists of a short audio delay line whose output is mixed together with the original signal. Mixing the delayed and original signals together results in multiple frequency cancellations creating a comb filter effect as shown in the diagram below. Since the flanger is a type of filter, it works best with harmonically rich sounds such as strings.

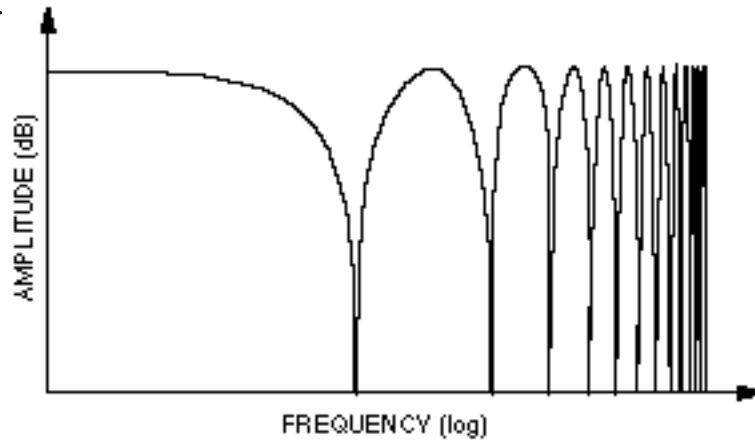

The flanging effect was originally created using two tape recorders playing identical recordings. By exactly synchronizing the two decks and then slowing the speed of one by grasping the tape reel flanges, the flanging effect was born.

The flanger in the Morpheus is a stereo device consisting of two separate delay lines controlled by a single set of controls. The block diagram of the flanger is shown below.

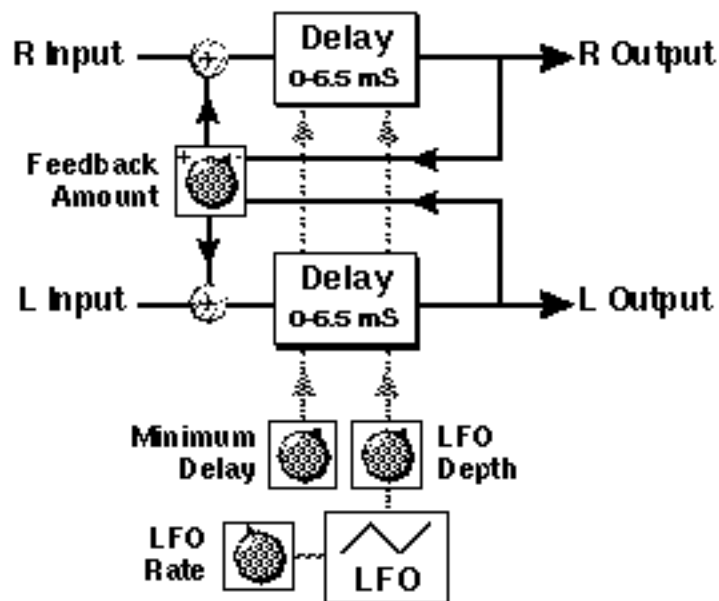

A Minimum Delay control serves to tune the flanger. In other words, it adjusts the placement of the comb filter notches. The initial delay is variable from 26 microseconds to 6.5 milliseconds.

FXA: StereoFlange Min Delay 100

A Low Frequency Oscillator (LFO) varies this initial delay setting, changing the frequency of the notches and adding animation to the sound. The LFO Rate controls the rate of change and the LFO Depth controls how much the delay is changed by the LFO. The LFO adds to the initial delay time so that with LFO Depth set to 255 the maximum delay time is 13 milliseconds.

FXA: StereoFlange LFO Rate 038
--

FXA: StereoFlange LFO Depth 150

The Feedback control sends some of the delayed signal through the delay line again. When positive feedback is used (values +1 to +127), the comb filter notches are deepened; when negative feedback is used (values -1 to -127) resonant peaks are formed between the notches which increase with the amount of negative feedback.

FXA: StereoFlange Feedback - 127
--

- Stereo Phaser

The stereo phaser is an effect similar to the flanger although much more subtle. The phaser creates a swirly animation when used with harmonically rich sounds such as strings and voices. It can also be used like a chorus to thicken-up a thin sound.

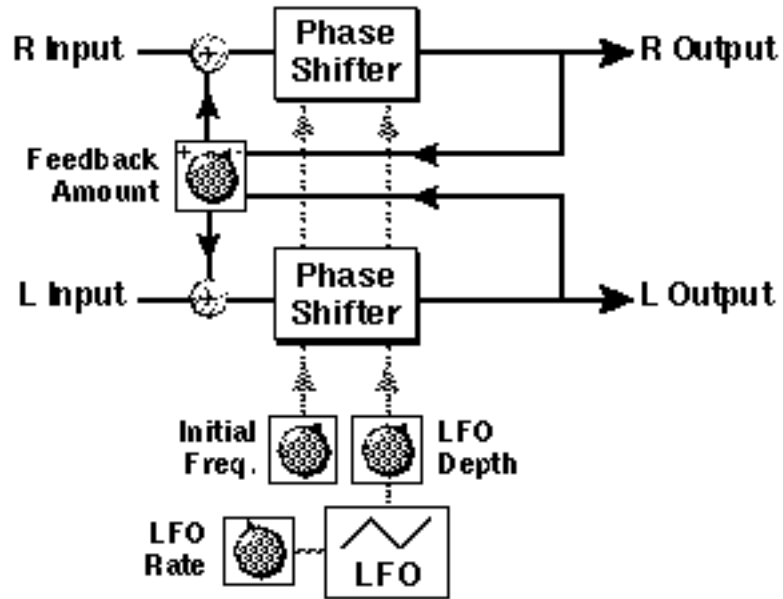

FXA: Phaser	
LFO Rate	060

FXA: Phaser	
LFO Depth	100

FXA: Phaser	
Min Freq	015

FXA: Phaser	
Feedback	064

- Stereo Chorus

The function of a chorus device is to thicken the sound or to make one voice sound like many. The way the effect is achieved is by mixing one or more delayed versions of the signal in with the original. The delay times used are too short to be perceived as an echo, but long enough so that comb filtering does not occur. In addition, the delay time is varied to simulate the random differences which occur when multiple instruments are playing together. A slight amount of feedback improves the effect by creating multiple images of the sound as it recirculates again and again. The delay times are slightly different for each channel and the LFO phase is inverted on the right channel to help contribute to the overall chorus effect. The LFO Rate and Depth settings are critical to achieving a realistic effect with faster LFO Rates generally requiring less LFO Amount and vice-versa.

The stereo chorus in the Morpheus is very similar to the stereo flanger except that the delay time is longer. The delay times for the stereo chorus range from 13 milliseconds to 52 milliseconds, compared with the 26 microsecond to 6.5 millisecond range of the flanger.

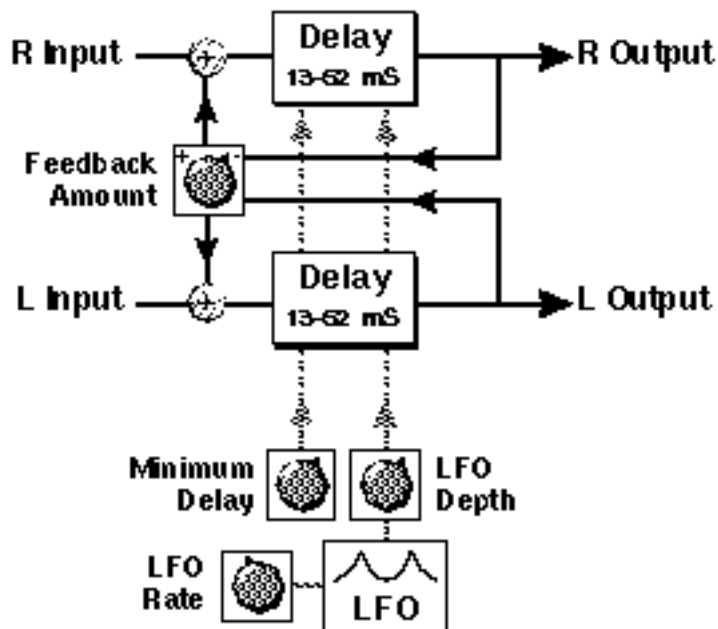

Chorus simulates the effect of multiple instruments playing by creating multiple copies of the sound using a varying delay time and feedback.

FXA: StereoChorus
LFO Rate 050

FXA: StereoChorus
Min Delay 036

FXA: StereoChorus
LFO Depth 050

FXA: StereoChorus
Feedback +100

• Delay

The delay line is a stereo effect which can be used for doubling, echoes or fixed formant comb filtering with completely independent delay time and tap levels for the left and right sides. The delay is shown in the diagram below.

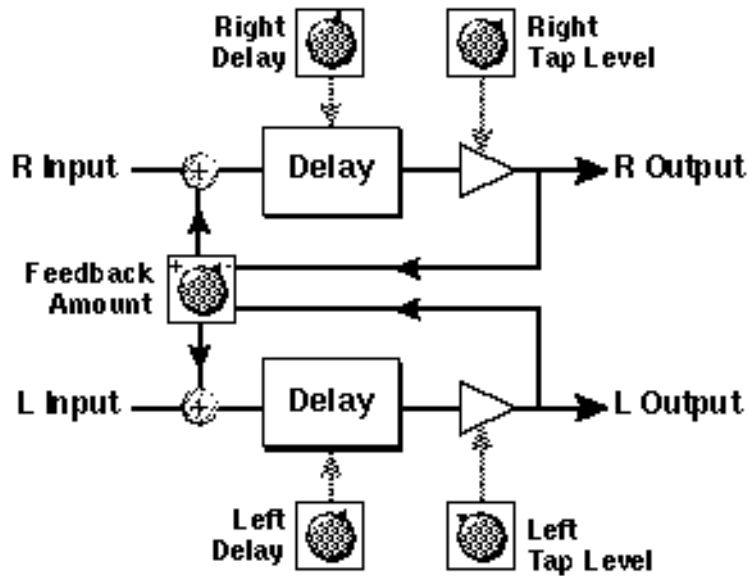

The Delay Time parameter is independently variable from 0 to 209 milliseconds for both the left and right channels. The Tap Level parameters control the amount of signal from the left and right delays as well as how much signal from each is supplied to the feedback control. Feedback controls how many echoes are produced. A setting of 0 produces only one echo. The delay line is incredibly stable even

with large amounts of feedback. This quality allows the delay line to be used as a resonator, where it acts as a kind of oscillator when excited by an input signal. Infinite delay effects are also possible without the risk of runaway. The stereo delay can function as two independent delay lines by panning the primary and secondary instruments to the extreme left and right.

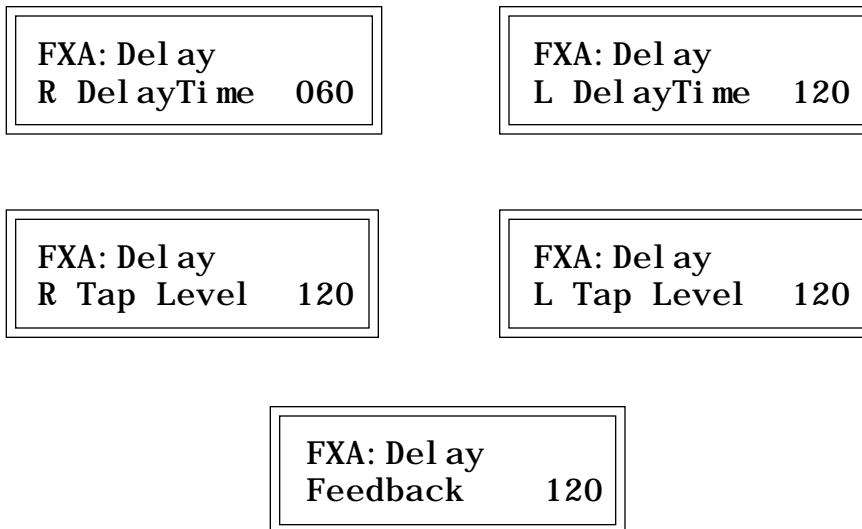

- Cross Delay

Cross Delay is identical to the normal delay line except that the output paths and the feedback paths cross over to the opposite channel in order to produce a ping-pong type of effect when reproduced in stereo. Delay time is adjustable from 0 to 209 milliseconds. The Cross Delay is shown in the diagram below.

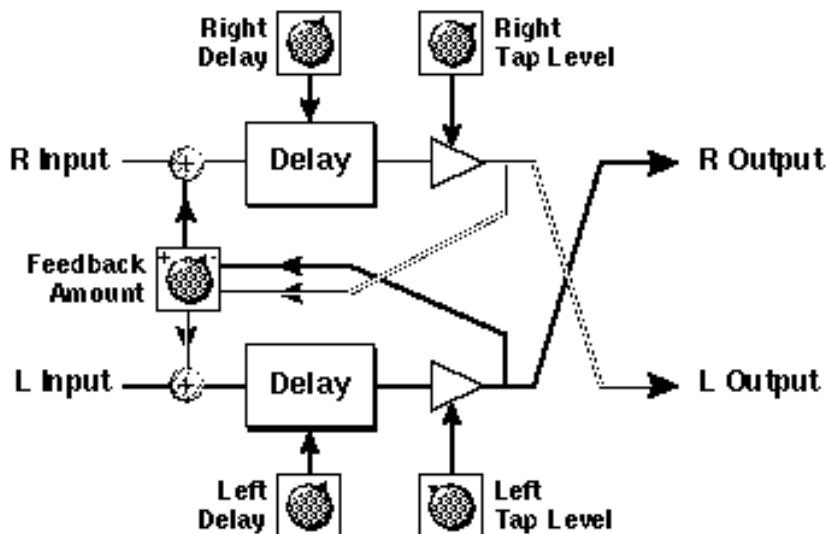

• Echo

The Echo produces echoes up to 400 milliseconds in length (twice that of the Delay and Cross Delay effects). The feedback path is independent of the output level and contains a low pass filter which simulates an analog tape echo. The left and right signals are kept completely independent throughout the effect and have separate controls except the feedback amount control which affects both channels.

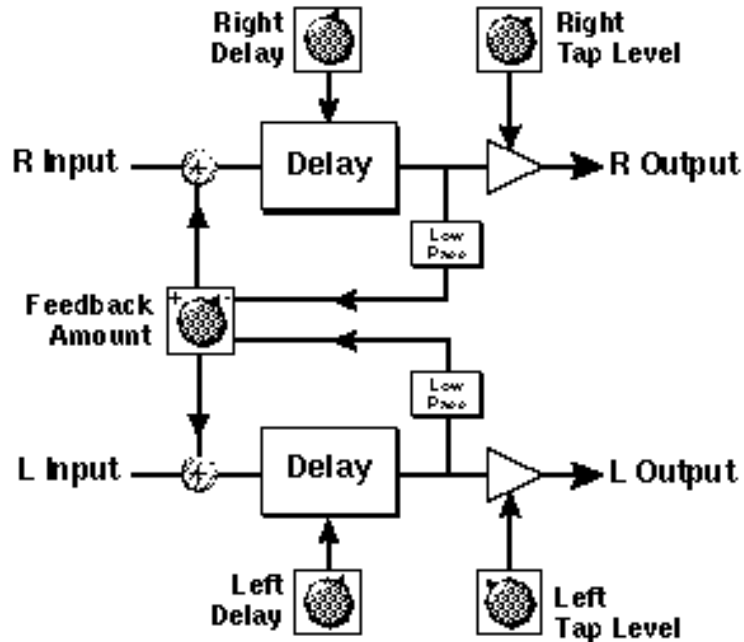

FXA: Echo
L DelayTime 120

FXA: Echo
R DelayTime 100

FXA: Echo
L Tap Level 127

FXA: Echo
R Tap Level 127

FXA: Echo
Feedback 100

B EFFECTS

The B effects include Stereo Flanger, Stereo Chorus, Phaser, Fuzz, Ring Modulator, Delay, Cross Delay and Fuzz Lite. Some of the B effects such as the Fuzz and the Ring Modulator are a bit bizarre (you won't want to use them on every sound), but can be used to create some truly amazing effects. The B effects can additionally be routed through the A effect as shown in the diagram below. Simple effects such as Fuzz can take on a completely new character when routed through the Reverb.

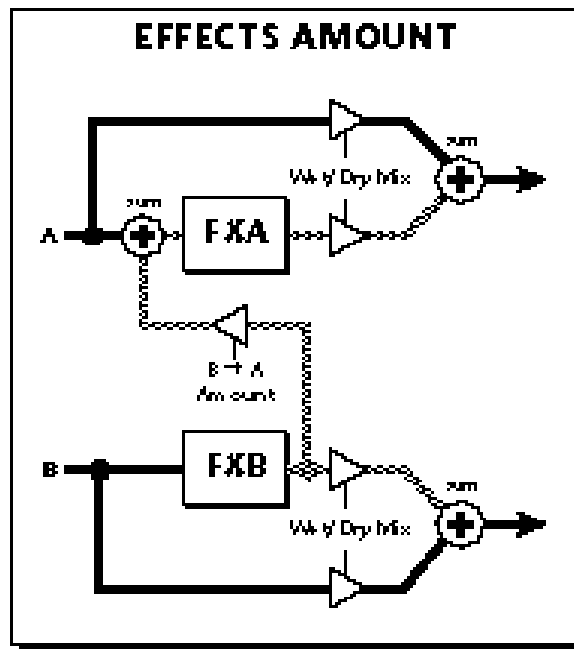

- Stereo Delay B

The B Delay is identical to the delay line in the A effect group except that the maximum delay time is 104 milliseconds (instead of 209 milliseconds). This delay is useful for short echoes, slapback and doubling effects, as well as for fixed formant comb filtering. Like Stereo Delay A, the feedback parameter is extremely stable even with high amounts, making it useful as a resonator for “infinite” delays.

- Stereo Cross Delay B

The B Cross Delay is identical to the cross delay line in the A effect group except that the maximum delay time is 104 milliseconds (instead of 209 mS). This delay is useful for short ping-pong echoes, stereo slapback and doubling effects.

STEREO FUZZ

The Stereo Fuzz introduces a controlled distortion to any signal passing through it. Distortion creates harmonics by clipping the top of the wave when it exceeds a certain level. Sine waves are transformed into square waves and complex waves take on noise-like qualities. There are two types of fuzz in Morpheus: Fuzz and Fuzz Lite.

• Fuzz

This Fuzz is probably the grunniest fuzz you have ever heard. Two filters, one at the input and one at the output of the fuzz, allow you to control the amount and type of harmonics added to the sound. The Input Filter controls the amount of harmonics produced by the fuzz and the Output Filter removes harmonics at the output, smoothing the sound. Higher values allow more harmonics to pass. The level of the input sound greatly affects the amount of fuzz, so that Morpheus' envelopes can now control harmonic content as well as the volume. Output Volume sets the output level of the fuzz. There are two complete fuzz effects, controlled by the same set of controls as shown in the diagram below.

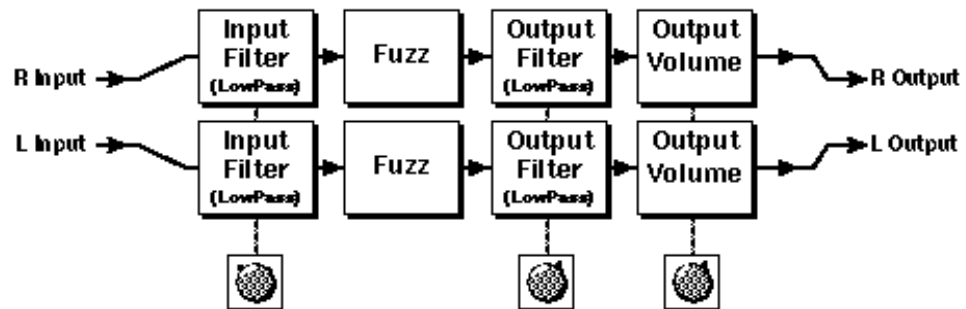

Two independent sounds can be processed by panning primary and secondary to opposite sides, or a single sound can be routed through both sides. If a single sound is panned slightly off center, the fuzz will act slightly differently on each side because of the difference in level.

• Fuzz Lite

This is a more restrained type of fuzz utilizing “soft-clipping”. As the level increases, the waveform through Fuzz Lite becomes somewhat squared. As signal level is increased further, it transforms into a square wave. There is no Output Volume control on Fuzz Lite.



Experiment with the way the input and output filters work on the sound. Fuzz is a specialized effect, not for every situation, but another powerful tool in your arsenal.

- Ring Modulator

A Ring Modulator is a device which takes two signals and multiplies them together into one resultant signal containing only the sum and difference frequencies of the two input waves. The original frequencies are not output! However, every harmonic of each signal multiplies every other, according to its amplitude. As a result, ring modulators tend to generate a lot of non-harmonic frequencies which can sound very bell-like or out of tune.

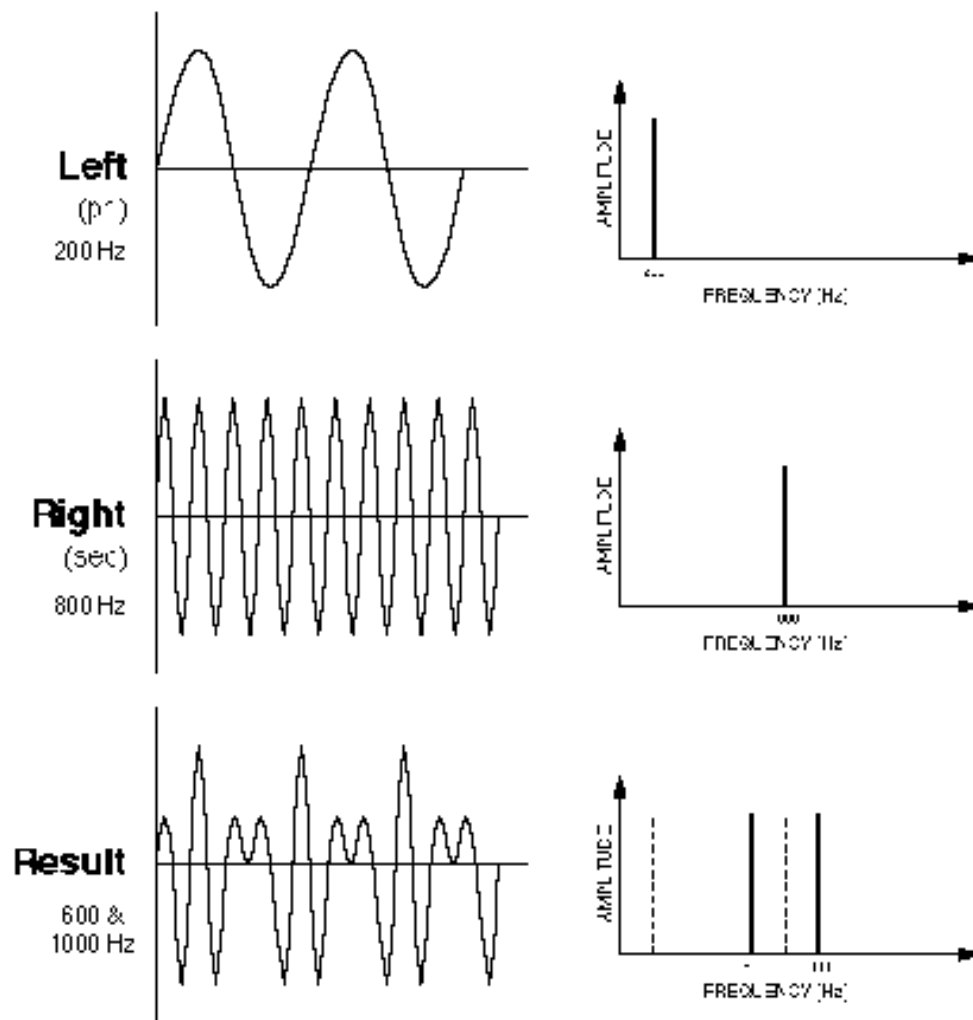

This diagram shows the result of Ring Modulating two sine waves with frequencies of 200 Hz and 800 Hz. Only the Sum and Difference frequencies of 1000 Hz and 600 Hz will result.

There are no controls on the ring modulator as shown by the block diagram below. The left and right outputs are simply multiplied together to form a monophonic output.

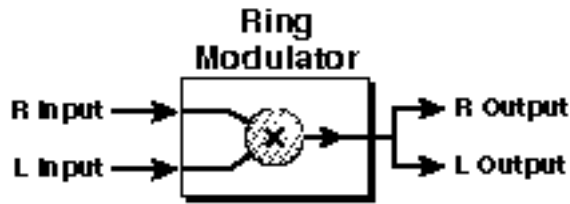

By routing the preset (or MIDI channel) to effect B and panning to opposite sides (shown below), two different waves can be ring modulated. Ring modulation works well with simple waves such as sine waves and the harmonic waveforms. Also, try complex waves modulated with sine waves. (Play chords!) Complex waveforms tend to sound rather noise-like.

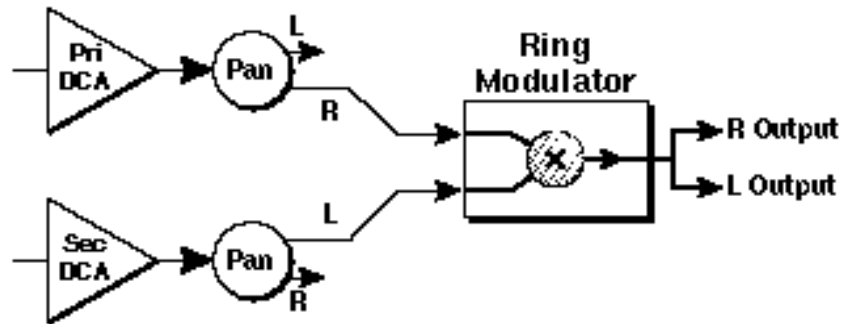

Pan the primary and secondary instruments to left and right in the pan screen, then move to the Effect B screen and select Ring Modulator. There are no parameters to adjust in this effect so the lower line of the display reads: None.



HYPERPRESET MENU

THE HYPERPRESET

A Hyperpreset is a group of one to sixteen presets which have been assigned to areas of the keyboard in order to have more than one sound available at once. Presets are assigned to ranges of the keyboard called Zones and may include 1 key or all 128 keys. Zones may be placed adjacent to each other (to create a split keyboard) or may overlap (to create fat, layered sounds). Each zone has its own volume, pan, transpose, tuning and velocity range.

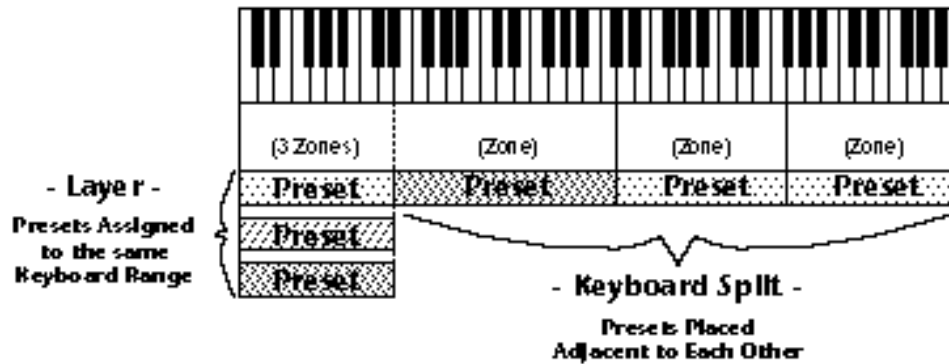

Up to sixteen presets can be assigned to the keyboard in any desired arrangement

To enable the Hyperpreset menu

Press the Hyper button, lighting the LED. The current screen will be the one most recently selected since powering up Morpheus. The Hyperpreset to be edited will be the LAST one selected or edited. The cursor will appear underneath the first character of the screen heading on line one.

To select a new screen

Press the Home/Enter button or press a cursor button repeatedly until the cursor is underneath the screen title heading. Rotate the data entry control to select another screen.

To modify a parameter

Press the Cursor button repeatedly (or hold the right cursor button while turning the data entry control) until the cursor is underneath the parameter value. Rotate the data entry control to change the value.

To compare an edited Hyperpreset with the unedited original

Press the Hyper button, turning off the LED. The unedited Hyper is now active. Changing the Hyperpreset number will erase the edit. To hear the edited hyperpreset again, press the Hyper button, lighting the LED.

To return to the main screen

Press the Hyper button, turning off the LED.

••• An additional 128 Hyperpresets can be stored on a memory card.

▼ In order to HEAR the Hyperpreset as you edit it, you must have it assigned to a MIDI channel in the main screen.

▼ Compare Mode must be turned On in the Master Menu for the Compare feature to work.

HYPERPRESET MENU FUNCTIONS

- Hyperpreset Name

Hyperpreset Name allows you to name each of the 128 hyperpresets with a name of up to 12 characters. Position the cursor under the character location and use the data entry control to change the character. The keyboard can also be used to select characters. The chart below shows the keyboard character assignments.

HYPERPRESET NAME
000² Bass/Lead

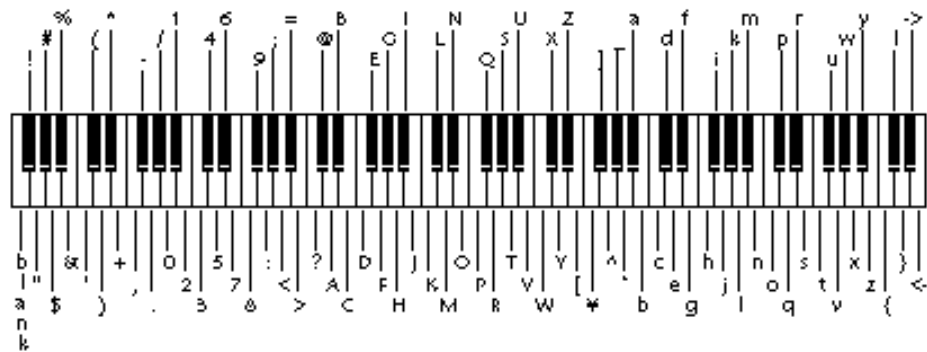

- Preset to Zone Assignment

This function allows you to select the preset which will be assigned to each of the sixteen keyboard zones. Position the cursor under the zone number and use the data entry control to change the zone number. Position the cursor under the preset number and use the data entry control to change the preset associated with each zone. Any preset can be assigned to a zone. Set the preset number of unused zones to Off (located below preset 000).

PRESET Z01
003⁰ Multi/Split

▮ If the Auto-Select function (in the Master Menu) is turned On, Zones will be selected as the keyboard is played. In the case of overlapping zones, the lowest one number will be selected. Velocity will select the zone if velocity switching has been programmed.

- Zone Volume and Pan

This function sets the Volume and Pan position for each zone. Volume allows you to adjust the relative volume between presets and pan allows you to change the position of each zone in the stereo field. The Volume control acts as an attenuator on the preset volume. It cannot increase the volume past the setting programmed in the preset. The Pan control adds algebraically to the pan value programmed in the preset. Therefore if the preset pan setting is -7, (full left) a hyperpreset pan setting of +14 would move the sound to (+7) the extreme right side of the stereo field.

Position the cursor under the zone number and use the data entry control to change the zone number. Position the cursor under the volume or pan number and use the data entry control to change the value for each zone.

VOLUME	PAN	Z01
127	+00	

- Zone Key Range

Key range sets the keyboard range associated with each of the sixteen possible zones. The key range of each zone can be set anywhere from key C-2 to G8.

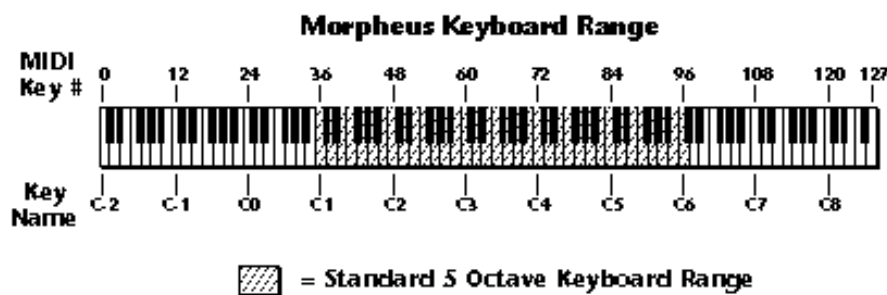

By placing the key ranges next to each other on the keyboard, multiple instruments can be accessed simultaneously. This is called “splitting” the keyboard because the keyboard is literally split up into different sections each containing a different sound.

If multiple presets are placed on the same range of the keyboard, they will all be played simultaneously. This is called “layering” since multiple presets are layered on top of one another. This results in a very dense, “fat” sound.

KEY RANGE	Z01
C- 2 - > G8	

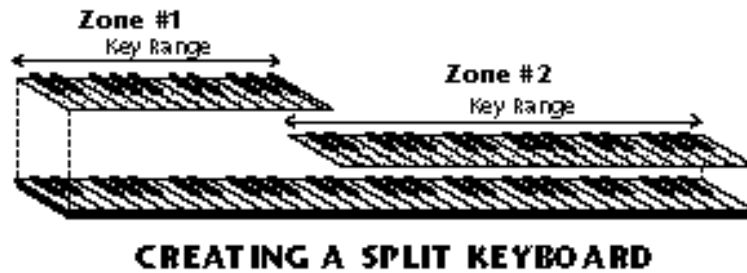

- Zone Velocity Range

Each zone can be given its own velocity range so that different presets will be selected according to the keyboard velocity. Imagine two presets assigned to the same keyboard range. If one preset were assigned the velocity range 000 to 64, and the other to velocity range 65 to 127, key velocities below 65 would select the first preset and key velocities 65 and above would select the second preset. Because there are sixteen possible zones, presets can be layered 16 deep!

```

VEL RANGE    Z01
low: 000    hi : 127
    
```

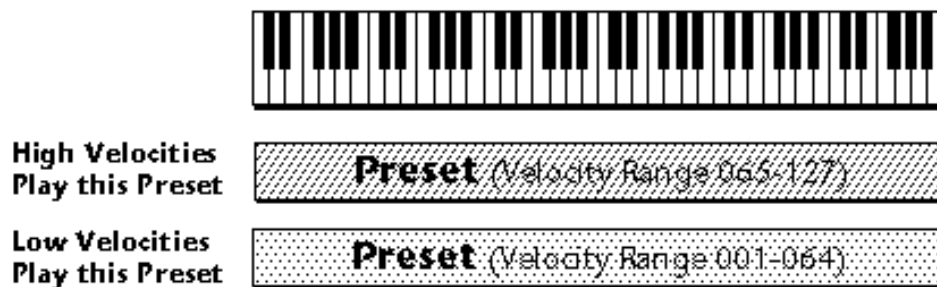

Zone Velocity Range allows you to select different preset layers according to key velocity.

- Zone Velocity Offset

This function works in conjunction with the Zone Velocity Range feature and adds a programmable offset value to the velocity value applied to the preset. The velocity offset is variable for each zone from -126 to +126.

Suppose that a preset is assigned a velocity range of 000-026 (see previous screen). If the preset was programmed with velocity to volume or tone, the low velocity range will make the preset soft and muted. By offsetting the velocity value to the preset by +100, the preset will receive velocity values of 100-126 instead of 000-026 and the preset will sound normal again.

VEL OFFSET	Z01
+000	

- Zone Transpose

The key of each zone can be transposed in half-step intervals. The range of the transpose function is ± 36 semitones (three octaves up or down). Transpose shifts the relative position of the keyboard in relation to middle C rather than actually changing the tuning of the zone.

TRANSPOSE	Z01
+36	

- Zone Pitch Tune

The tuning of each zone can be adjusted in coarse and fine increments. The coarse tuning adjustment tunes the zone in semitone increments. This is different from the transpose function in that the sounds are actually retuned, rather than having the relative key position changed. This control can produce radical timbre shifts in the sampled sounds. The range of the coarse tuning control is ± 36 semitones (± 3 octaves). The fine tuning control changes the pitch in $1/64$ semitone increments (approx. 1.56 cents). The fine tuning range is ± 1 semitone.

PITCH TUNE	Z01
crse+36	fi ne+64

▼ If the Auto-Select function (in the Master Menu) is turned On, Zones will be selected as the keyboard is played.

- **Hyperpreset Portamento Mode**

This function sets the number of notes that will be affected by portamento for all presets in a hyperpreset which have portamento turned On. It works exactly the same as preset portamento mode, but controls the mode for the hyperpreset.

If the Portamento Mode is set to two keys and a three-note chord is played, only two of the notes will glide. Notes will glide from the previous note or notes played. By setting the number of keys to match the number of notes in your chords, smooth glides between those chords can be accomplished without having notes glide in from random starting points. The number of keys can be set from mono to five-note polyphonic.

PORTAMENTO MODE
Poly 2 keys

Free-Run Function Generator

The function generator is another kind of modulation source which is much more programmable than an envelope generator or an LFO (although it can function as either). The function generator can be used when you want the type of complex control that a normal AHDSR envelope cannot provide. See the Function Generator description in the Preset Programming section for complete details.

•• The function generator tapes are diagrammed on page 214 of this manual.

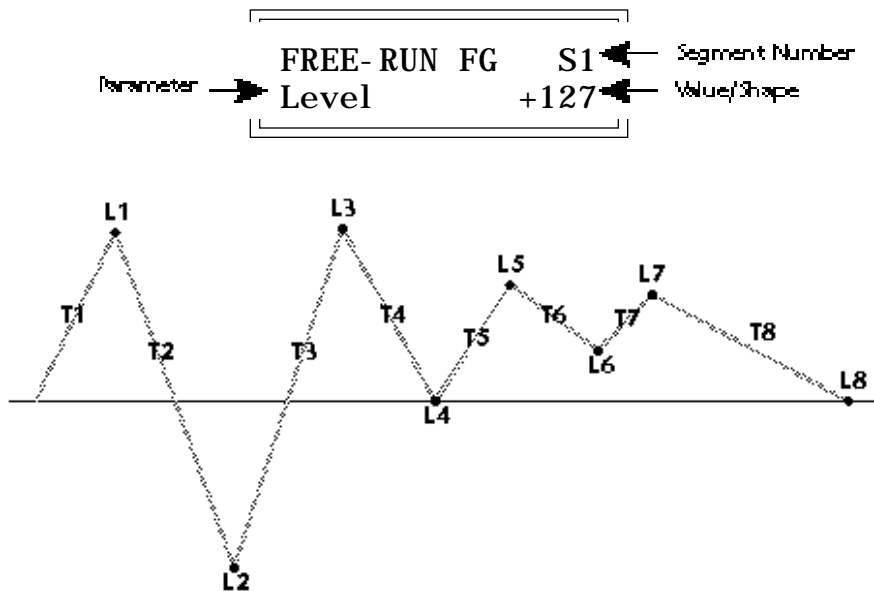

Function Generators contain up to eight segments, each with a level, time, shape, and conditional jump parameter. The Free-Run FG is a kind of "Master" controller which can control all presets contained in a hyperpreset.

Hyperpresets contain a slightly different version of the function generator called a Free-Running Function Generator or Free-Run FG. There is one Free-Run FG per hyperpreset (effectively one per MIDI channel). What the Free-Run FG actually controls is programmed in the preset itself.

The Free-Run FG differs from the other FGs in two fundamental ways. There is one Free-Run FG per Hyperpreset which can modulate any presets in the hyper which have the Free-Run FG assigned. This differs from the 2 function generators in the preset which are completely independent from note to note. Because the Free-Run FG is like a global modulation source, it can be used when you want to modulate multiple sounds in the same way. The Free-Run FG is only active when playing a Hyperpreset.

••• See the Programming Basics section of this manual for additional information or the Function Generators.

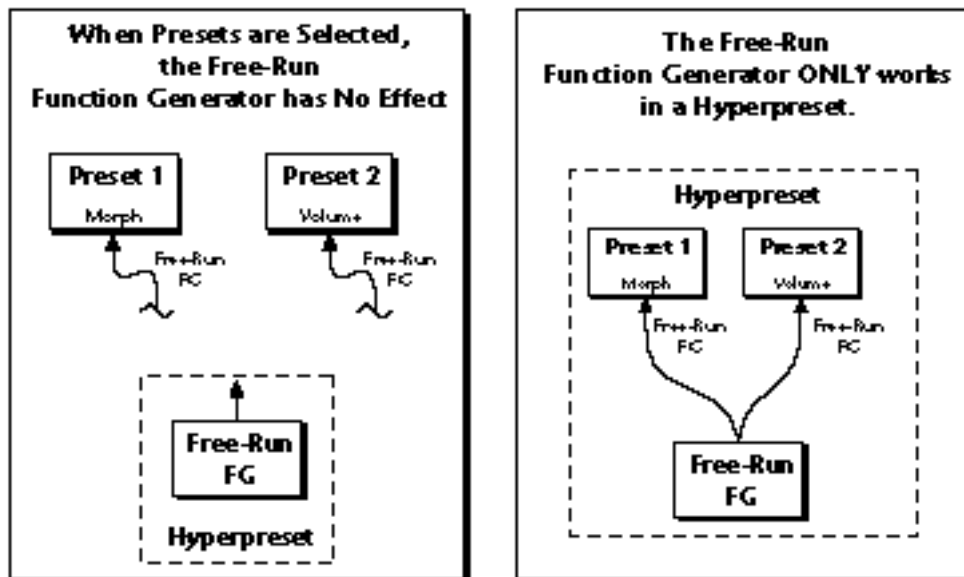

The Free-Run Function Generator only works in a Hyperpreset, even though the modulation routing is made in the preset.

For example, you could program the Free-Run FG to be an LFO and modulate the pitch. All the voices in all presets in that hyperpreset with Free-Run FG assigned would modulate up and down in unison. The Free-Run FG begins the instant the hyperpreset is selected and continues to run until stopped by its programming or when another hyperpreset is selected. If the Free-Run FG is not programmed to loop, it simply runs to the last segment and stops! Because it continually runs (if so programmed) and is not started at the beginning of a note like the preset function generators, it is called “free-running”.

The functions of the Free-Run FG are almost identical to the preset FG's except that the conditional jumps are more limited. The conditional jumps are listed below.

- Never Never jumps. Always goes on to next segment.
- Always End Always jumps at the end of the current segment.
- Note On End..... Jumps at the end of the segment if the note is still on.
- Note On Imm. Jumps immediately if the note is still on.
- Note Off End Jumps at the end of the segment if the note is off.
- Note Off Imm. Jumps immediately if the note is off.
- Footsw. 1-3 End..... Jumps at the end of the segment if the selected Footswitch is pressed.
- Footsw. 1-3 Imm. Jumps immediately if the selected Footswitch is pressed.

- Save Hyperpreset

Changes made to a hyperpreset are NOT made permanent until the hyperpreset is Saved. To save a hyperpreset, move the cursor to the bottom line and select the location for the new hyperpreset with the data entry control. The Enter LED will be flashing. Pressing the Enter switch will confirm the operation. Any of the hyperpreset locations may be selected. Saving to a hyper erases the existing hyper in that location. Make sure that the destination does not contain information you want to keep.

**SAVE HYPER to...
000² SynBass/Lead**

FILTER MODULATION

The block diagram of a single channel is shown below.

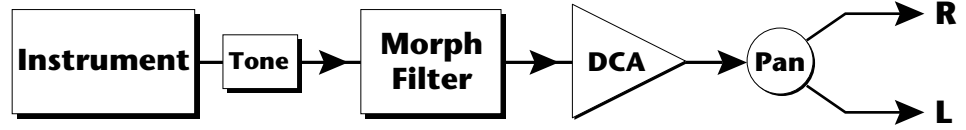

The **Tone** filter is a simple low-pass tone control which can be used to darken the tone of an instrument. The **Z-Plane** filter is an ultra-powerful synthesizer filter which can dramatically alter the sound of an instrument.

To understand how a filter works we need to understand what makes up a sound wave. A sine wave is the simplest form of sound wave. Any waveform except a sine wave can be analyzed as a mix of sine waves at specific frequencies and amplitudes.

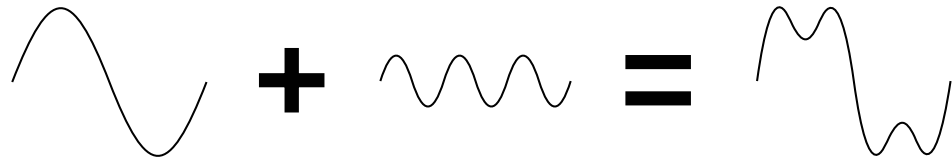

Any waveform can be analyzed as a mixture of sine waves.

One way to represent complex waveforms is to use a chart with frequency on one axis and amplitude on the other. Each vertical line of the chart represents one sine wave at a specific amplitude and frequency.

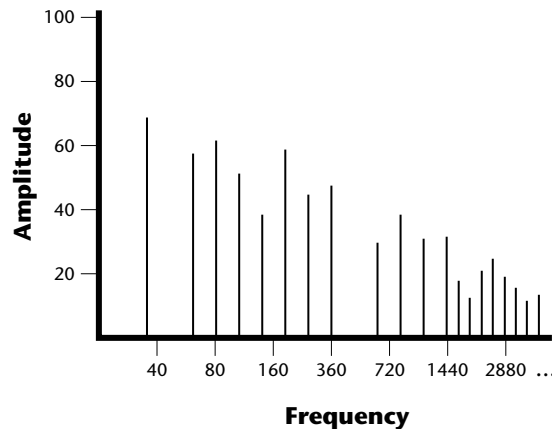

WHAT IS A FILTER?

Most of the instruments in Morpheus are complex waves containing many sine waves of various amplitudes and frequencies. A **filter** is a device which allows us to remove certain components of a sound depending on its frequency. For example, a *Low Pass Filter* lets the *low frequencies pass* and removes only the high frequencies.

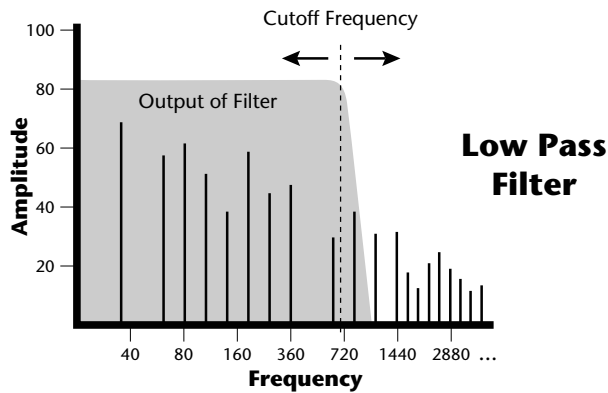

A filter that lets only the high frequencies pass is called a *High Pass Filter*.

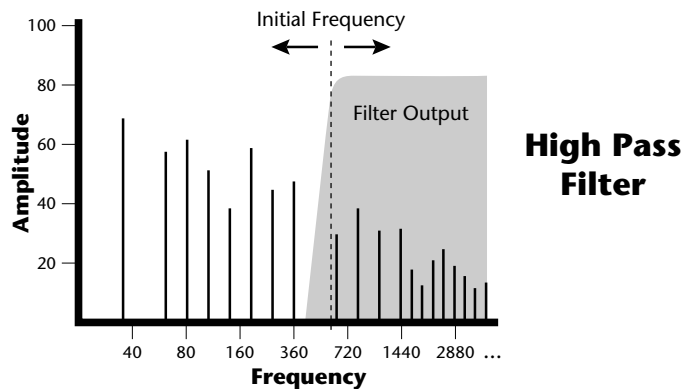

A filter which only lets a certain band of frequencies pass is called a *Bandpass Filter*.

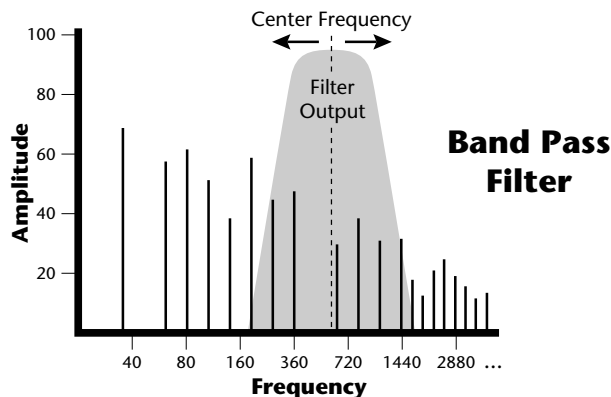

A *Notch Filter* is just the opposite of a bandpass filter and is used to eliminate a narrow band of frequencies.

Another control found on traditional filters is called Q or resonance. A lowpass filter with a high Q would emphasize the frequencies around the cutoff frequency. The chart below shows how different amounts of Q affect the low pass filter response. In terms of sound, frequencies around the cutoff will tend to “ring” with high Q settings. If the filter is slowly swept back and forth, with a high Q, various overtones will be “picked out” of the sound and amplified as the resonant peak sweeps over them. Bells and gongs are real world examples of sounds which have a high Q.

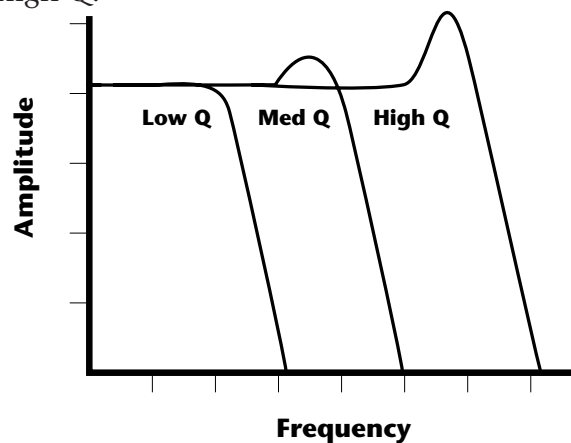

Another parameter on a filter is the number of poles it contains. Traditional synthesizer filters were usually either 2-pole or 4-pole filters. The number of poles in a filter describes the steepness of its slope. The more poles, the steeper the filter's slope and the stronger the filtering action. The tone controls on your home stereo are probably one-pole or two-pole filters. Parametric equalizers are usually either two-pole or three-pole filters. In terms of vintage synthesizers, Moog and ARP synthesizer filters used 4-pole filters, Oberheim synthesizers were famous for their 2-pole filter sound.

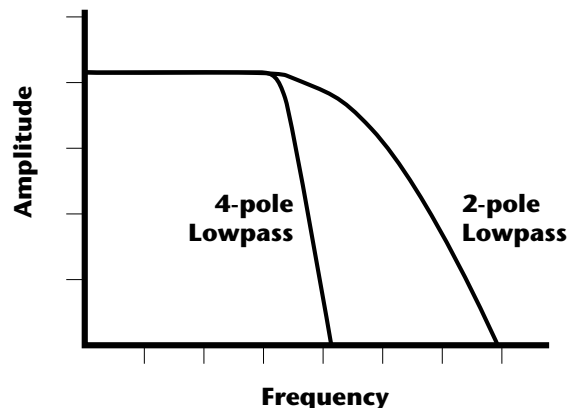

Using a filter, we now have a way to control the harmonic content of a sampled sound. As it turns out, even a simple low pass filter can simulate the response of many natural sounds.

For example, when a piano string is struck by its hammer, there are initially a lot of high frequencies present. If the same note is played softer, there will be fewer of the high frequencies generated by the string. We can simulate this effect by routing the velocity of the keyboard to control the amount of high frequencies that the low pass filter lets through. The result is expressive, natural control over the sound.

If an envelope generator is used to control the cutoff frequency of a low pass filter, the frequency content can be varied dynamically over the course of the note. This can add animation to the sound as well as simulate the response of many natural instruments.

PARAMETRIC FILTERS

A more complex type of filter is called a parametric filter. A parametric filter gives you control over three basic *parameters* of the filter. The three parameters are: *Frequency*, *Bandwidth*, and *Boost/Cut*. The Frequency parameter allows you to select a range of frequencies to be boosted or cut, the Bandwidth parameter allows you to select the width of the range, and the Boost/Cut parameter either boosts or cuts the frequencies within the selected band by a specified amount. Frequencies not included in the selected band are left unaltered. This is different from a band pass filter which attenuates (reduces) frequencies outside the selected band.

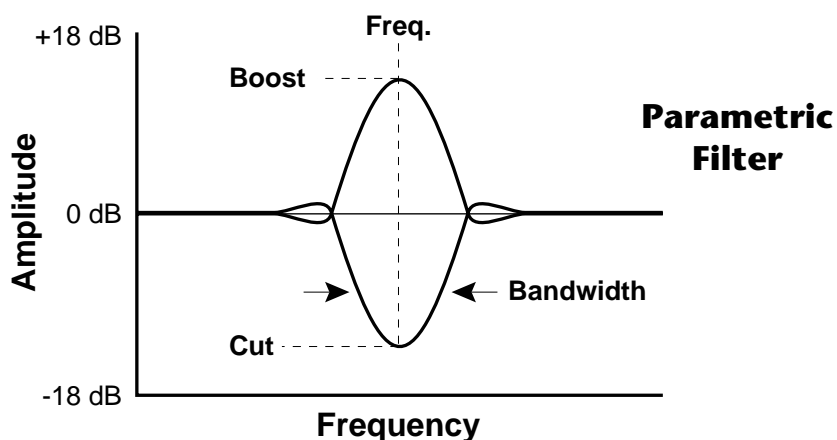

The parametric filter is quite flexible. Any range of frequencies can be either amplified or attenuated. Often times, several parametric sections are cascaded (placed one after another) in order to create complex filter response curves.

If four parametric filter sections were cascaded, it would be possible to create the following complex filter response.

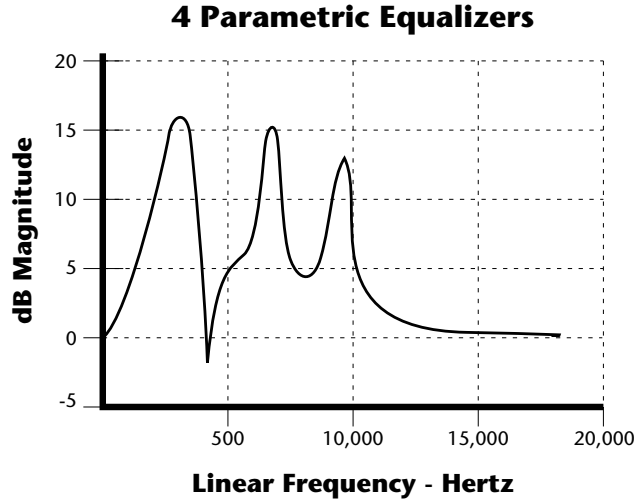

Many natural instruments have complex resonances which are based on their soundboard or tube size. The resonance shown above would be impossible to create using a normal synthesizer filter.

THE MORPHEUS FILTER

The Morpheus filter is actually much more complex than the four parametric sections described above. As an example of its power, the diagram below shows one of the possible ways that the Morpheus filter can be configured. This amount of filtering is unprecedented in all of electronic music history. (Especially when you consider that we are only talking about one of the 32 channels.)

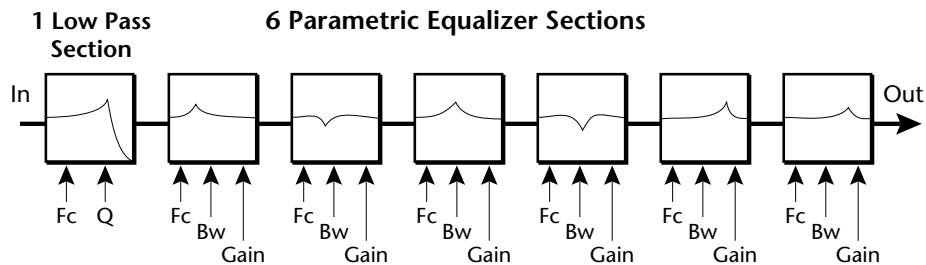

Right away you can see that we now have 20 different parameters to control. Ah, there's the catch. How can all these parameters be effectively controlled? 20 envelope generators? We don't think so.

Consider, as an example, the human vocal tract, which is a type of complex filter or resonator. There are dozens of different muscles controlling the shape of the vocal tract. When speaking, however, we don't think of the muscles, we just remember how it feels to form the vowels. A vowel is really a configuration of many muscles, but we consider it a single object. In changing from one vowel to another, we don't need to consider the frequencies of the resonant peaks! You remember the shape of your mouth for each sound and **interpolate** between them.

THE Z-PLANE FILTER

In a simple Morpheus filter, we would start with two complex filters and interpolate between them using a single parameter. Refer to the diagram below.

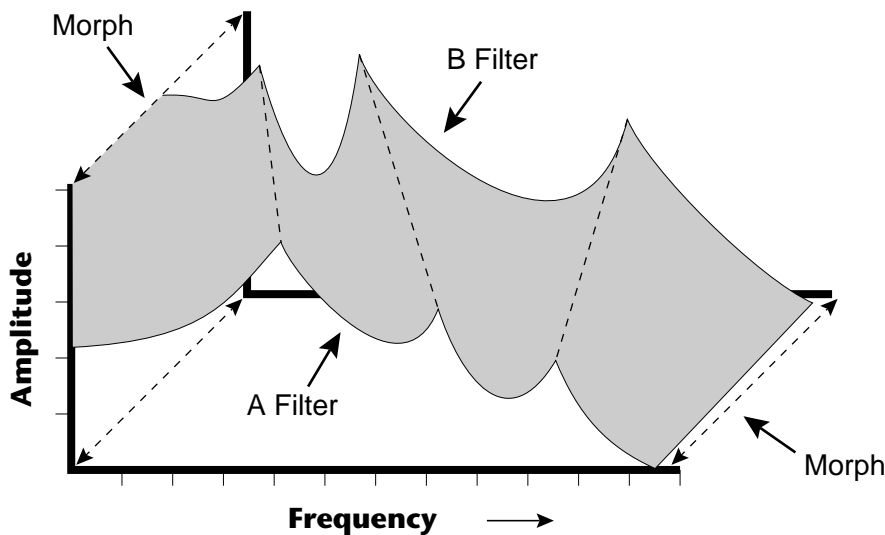

The Morpheus Z-plane filter has the unique ability to change its function over time.

Filters A and B represent two different complex filters. By changing a single parameter, the **Morph**, many complex filter parameters can now be changed simultaneously. Following along the Morph axis you can see that the filter response smoothly interpolates between the two filters. This is the essence of the Z-plane filter. Through the use of interpolation, many complex parameters are condensed down into one manageable entity.

This Z-Plane filter sweep can be controlled by an envelope or function generator, an LFO, modulation wheels or pedals, keyboard velocity, key pressure, etc. In fact, any of the modulation sources can control the Z-Plane filter.

Because creating the complex filtering is difficult and very time consuming, we have created hundreds of filters and installed them permanently in ROM for your use. You simply select and use the filters in a manner similar to choosing an instrument. Because there are so many types of filters to choose from, the number of possible permutations is staggering. For example, you could play a guitar sound through a vocal tract filter and create a talking guitar sound. Or you could have an acoustic guitar whose body shape changes as you play.

In the current example, two complex filters were created and the Morph parameter was used to interpolate between them. This is the simplest way to visualize a Morpheus filter



The next logical extension of this two filter model would be to add yet another filter pair. The diagram below shows an example using four filters. Now we have *two* parameters that can be controlled.

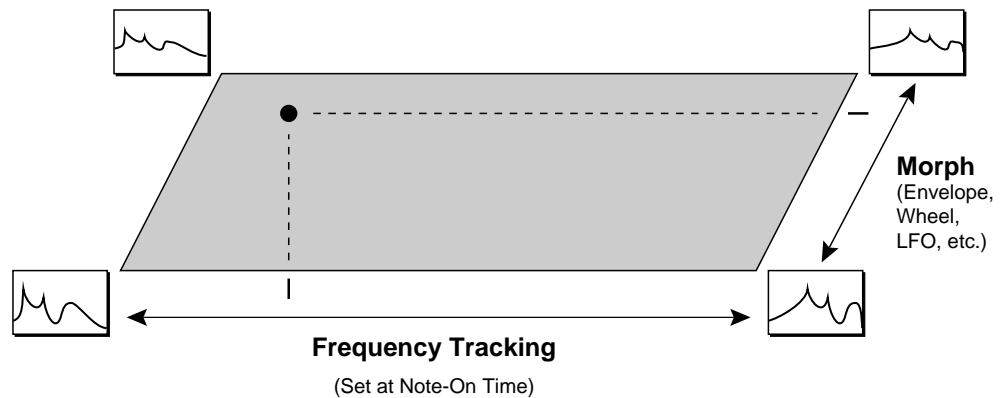

••• See the Step-By-Step chapter for more information on the Z-plane filters.

The diagram above, adds a *Frequency Tracking* parameter which varies the frequency of the filter. If we had set the frequency tracking and morph parameters as shown in the diagram above, the dot would represent the resulting filter position: a mixture of all four, but closest in nature to the left rear filter.

In the Morpheus filter there is *only one* parameter that can be continuously varied in realtime and that is the **Morph** parameter. Other filter parameters, such as *Frequency Tracking*, can only be changed at note-on time.

Suppose we added yet another dimension to the filter model. We could have the realtime *Morph* parameter, the *Frequency Tracking* parameter (set at note-on time) and one more parameter, perhaps controlling the amount of the filter peaks with key velocity. A way to visualize a three-dimensional filter model is shown by the diagram below.

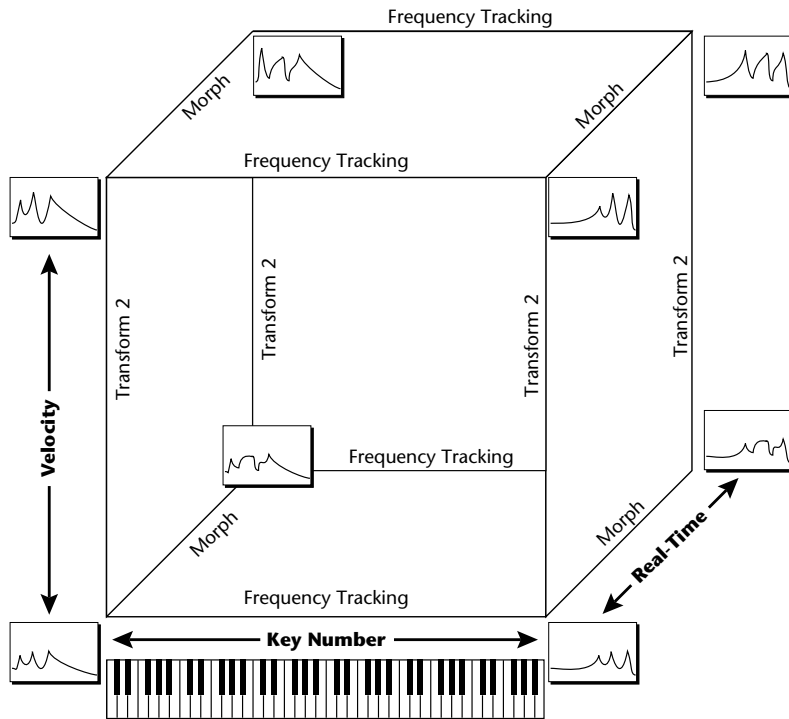

••• If the frequency graphs at the corners of the cube are confusing you, think of them as the settings on a graphic equalizer.

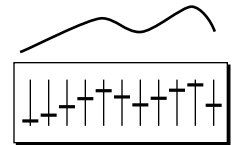

The **Cube** filters are actually constructed of eight different complex filters.

Each axis of the three-dimensional cube changes the filter in a different way. In the example above, key number is being applied to the Frequency Tracking parameter in order to make the filter frequency track or follow the notes played on the keyboard. Assigning the Keyboard to frequency is called *Key Tracking* and is used to keep the timbre of the sound constant as you play up and down the keyboard. Without key tracking the sound would get duller as you move up the keyboard and could sound completely different at opposite ends of the keyboard. Because Frequency Tracking is so important it has been assigned its own parameter which is used in many of the filters (there are exceptions).

In the filter model above, there is another note-on (defined at the time the note is pressed) parameter, **Transform 2**. Unlike the Frequency Tracking parameter, the effect of Transform 2 may vary from filter to filter. In the example above, Transform 2 is being used to vary the size of the peaks and notches in the filter. The frequency plots in the upper plane of the cube have sharper peaks. Key velocity could be used to control Transform 2 and the sharpness of the filter peaks.

••• Note: The Frequency Tracking parameter is Transform 1.

• Another View

Another way to look at the Z-Plane filter is simply as a “black box”. You don't really need to think about all the possible filter permutations in order to use it. You just need to know what the controls do and listen to the sound. Each Z-Plane filter is described in the Reference Section of this manual.

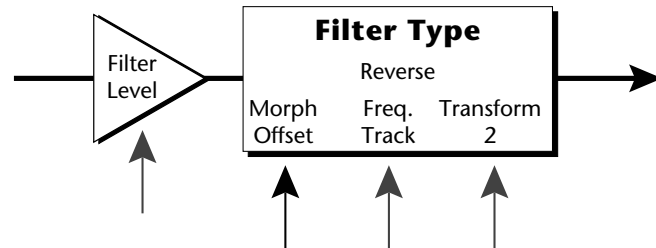

The Z-Plane filter can change its function in time.

Imagine a Lowpass filter transforming into a Bandpass filter. The Morph parameter (Morph Offset) typically handles this type of function.

Lowpass Filter Morphing into a Bandpass Filter

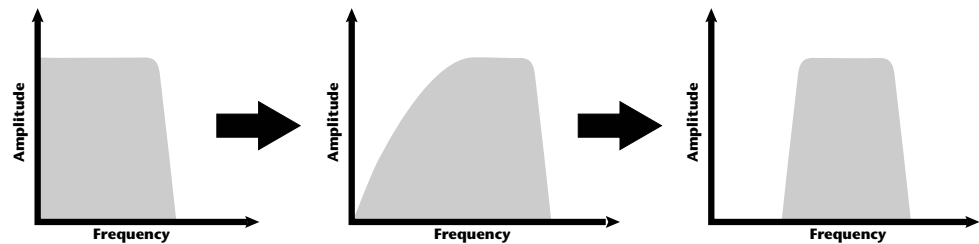

••• On some filters, the Frequency Tracking parameter DOES NOT control the filter frequency. See the filter descriptions in the Reference Section for details.

The Morph and Transform 2 parameters vary in function from filter to filter. **About half of the Z-Plane filters are not Cubes and therefore DO NOT use Transform 2.** The Frequency Tracking parameter usually controls the frequency of the filters, moving peaks, shelves or notches up and down in frequency. Refer to the Reference Section of this manual for specific information on each filter.

Many of the filter types in Morpheus are models of traditional acoustic instruments such as electric piano or guitar. When an electric piano sample is played through an electric piano filter, the harmonics of the sample can now be controlled using the filter parameters.

Of course, you can put any instrument through the filter and the filter will shape the basic character of the instrument. This “building-block” approach to synthesis is only a part of what makes Morpheus such a unique and powerful synthesizer.

MORPHEUS SIGNAL FLOW

Going back to the block diagram for a single channel we can re-examine the complete signal path.

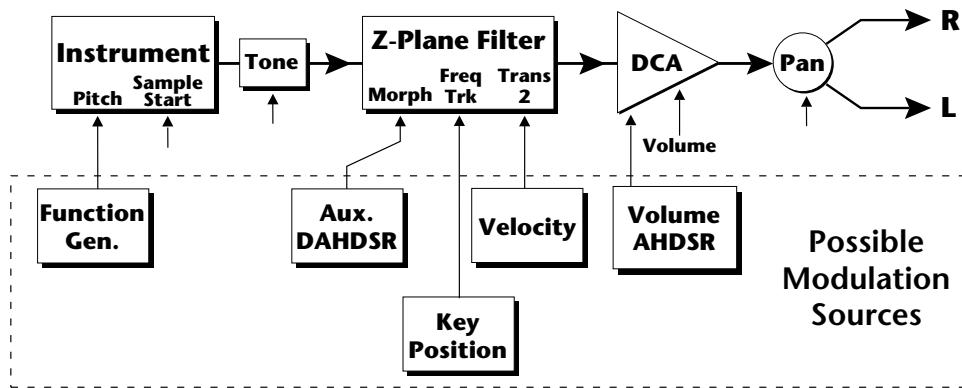

The vertical arrows represent possible modulation routings to the basic signal path.

Instrument

This is the sampled sound wave. The pitch of the instrument can be modulated by any modulation source. The sample start point can only be modulated by a velocity or key source (see the next page).

Tone

Tone is a simple low-pass tone control which can be used to darken the sound. Tone can only be set at Note-On time (see the next page). Key velocity is commonly used to modulate the tone (*in a negative way*) so that the harder you play, the brighter the sound becomes.

Z-Plane Filter

The Z-Plane Filter controls the harmonic content of an instrument in a highly controlled manner. Any modulation source can be used to control the various aspects of this complex filter.

DCA

Digitally **C**ontrolled **A**mplifier. Together with the Alternate Volume AHDSR, the DCA is used to shape the volume contour of a sound. The DCA can be controlled by any modulation source. Key Velocity is often used as a modulation source for the DCA so that the harder you play, the louder the sound becomes.

Pan

Adjusts the balance of sound between the left and right channels.

PRESET PROGRAMMING

Note-On

Modulation Sources

Key Number, Key Velocity
 Initial Pitch Wheel Amount
 Initial Controller A Amount
 Initial Controller B Amount
 Initial Controller C Amount
 Initial Controller D Amount
 Initial Mono Pressure Amount
 Initial FR Func. Gen. Amount

Destinations

Off
 Pitch, Primary Pitch
 Secondary Pitch
 Volume, Primary Volume
 Secondary Volume
 Attack, Primary Attack
 Secondary Attack
 Decay, Primary Decay
 Secondary Decay
 Release, Primary Release
 Secondary Release
 Crossfade
 LFO 1 Amount, LFO 1 Rate
 LFO 2 Amount, LFO 2 Rate
 Auxiliary Envelope Amount
 Auxiliary Envelope Attack
 Auxiliary Envelope Decay
 Auxiliary Envelope Release
 Function Gen 1 Amount
 Function Gen 2 Amount
 Portamento Rate
 Primary Portamento Rate
 Secondary Portamento Rate
 Filter Morph
 Primary Filter Morph
 Secondary Filter Morph
 Pan, Primary Pan
 Secondary Pan
 Sample Start
 Primary Sample Start
 Secondary Sample Start
 Tone, Primary Tone
 Secondary Tone
 Filter Level, Primary Filter Level
 Secondary Filter Level
 Filter Frequency Track
 Primary Filter Frequency Track
 Secondary Filter Freq. Track
 Filter Transform 2
 Primary Filter Transform 2
 Secondary Filter Transform 2

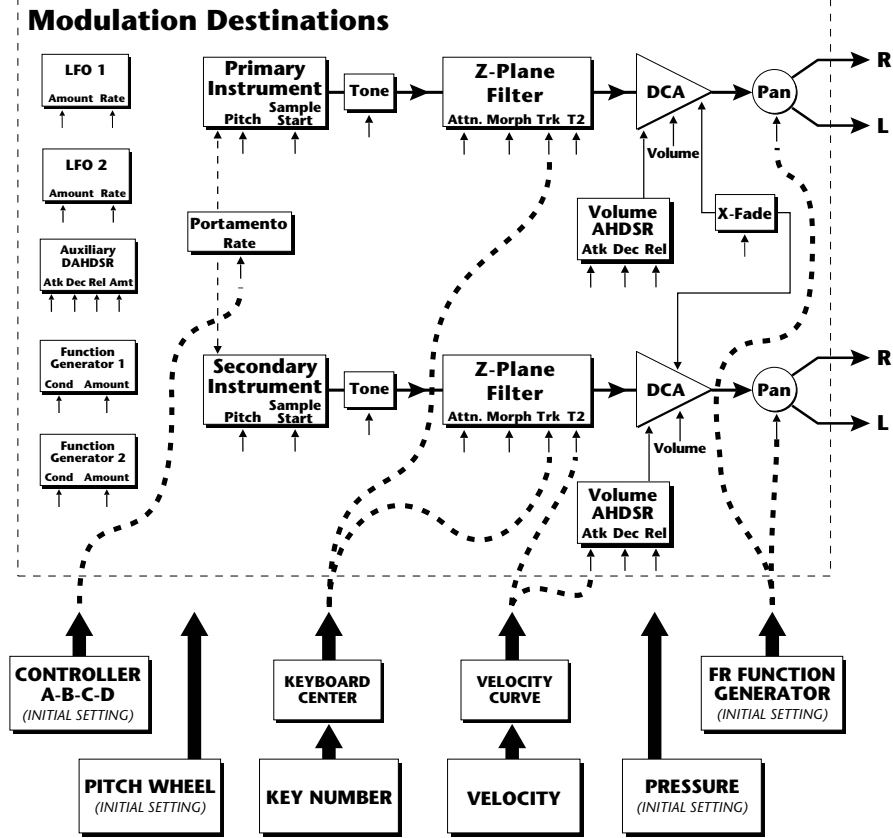

Note-On Modulation Sources

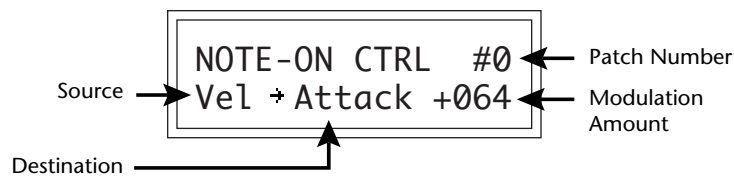

NOTE-ON MODULATION CONTROL

Modulation sources must be connected to a destination in order to have any effect. The diagram and the LCD screen above show how modulation sources are connected to destinations. The modulation sources can control any of the destinations indicated by the small arrows.

▼ Note-On modulation sources are only measured once at Note-On time, hence the name. Even a controller like the Pitch Wheel is only measured once (at note-on time) when routed as a Note-On control. The Realtime Modulation screen (on the next page), allows continuous variation.

The possible modulation routings are completely flexible as shown in the diagram above. Multiple sources can control the same destination, or a single source can control multiple destinations.

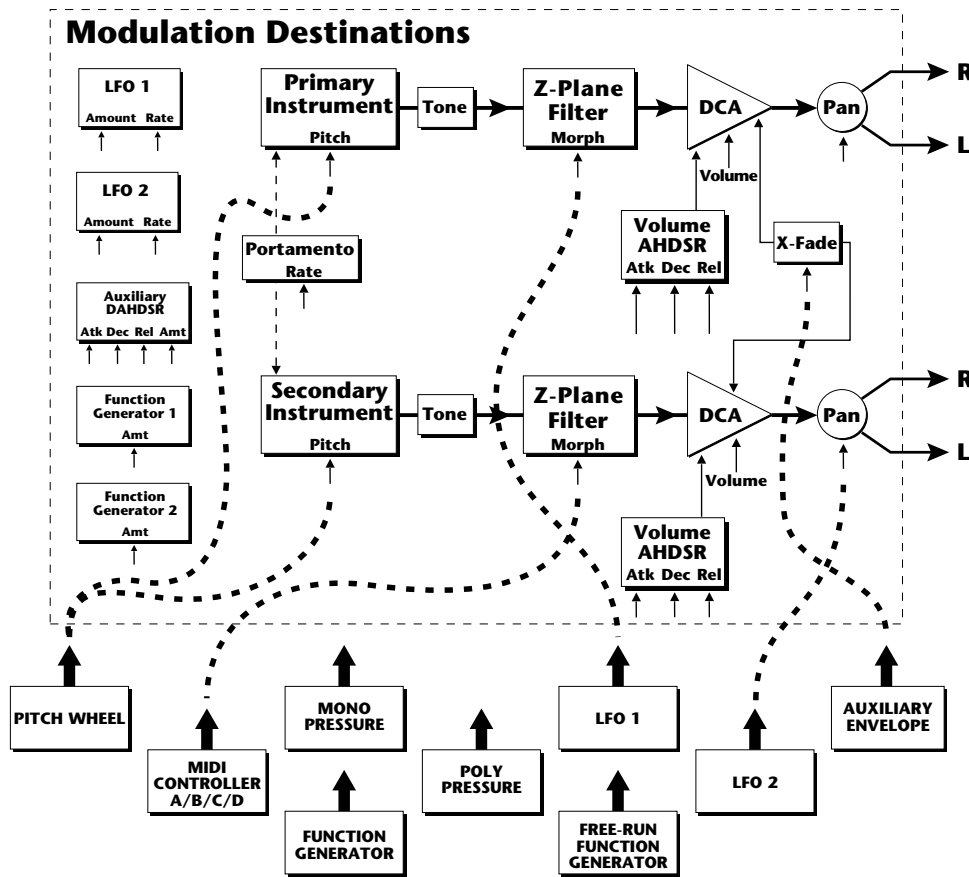

Realtime Modulation Sources

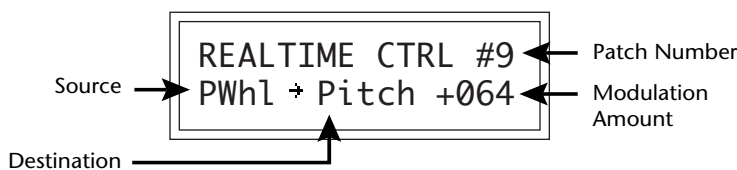

REALTIME MODULATION CONTROL

Realtime modulation sources are parameters which can be continuously varied over time. The velocity and keyboard modulations, in comparison, are set at the key depression. Modulation sources must be connected to a destination in order to have any effect.

The diagram and the LCD screen above show how modulation sources are connected to destinations. The modulation sources can control any of the destinations indicated by the small arrows. The possible modulation routings are completely flexible as shown in the diagram above. Multiple sources can control the same destination, or a single source can control multiple destinations.

- Realtime Modulation Sources**
- Pitch Wheel
 - MIDI Control A
 - MIDI Control B
 - MIDI Control C
 - MIDI Control D
 - Mono Pressure
 - Polyphonic Pressure
 - LFO 1, LFO 2
 - Auxiliary Envelope
 - Function Generator 1
 - Function Generator 2
 - Free-Run Function Generator

- Destinations**
- Off
 - Pitch, Primary Pitch
 - Secondary Pitch
 - Volume, Primary Volume
 - Secondary Volume
 - Attack, Primary Attack
 - Secondary Attack
 - Decay, Primary Decay
 - Secondary Decay
 - Release, Primary Release
 - Secondary Release
 - Crossfade
 - LFO 1 Amount, LFO 1 Rate
 - LFO 2 Amount, LFO 2 Rate
 - Auxiliary Envelope Amount
 - Auxiliary Envelope Attack
 - Auxiliary Envelope Decay
 - Auxiliary Envelope Release
 - Function Gen 1 Amount
 - Function Gen 2 Amount
 - Portamento Rate
 - Primary Portamento Rate
 - Secondary Portamento Rate
 - Filter Morph
 - Primary Filter Morph
 - Secondary Filter Morph
 - Pan, Primary Pan
 - Secondary Pan

When Modulating Envelope Attack, Decay or Release Times:

Positive amounts of modulation **increase** the time.
 Negative amounts of modulation **decrease** the time.

KEY NUMBER

The Key Number is affected by the Keyboard Center parameter which can be set to any key from A-1 to C7. The keyboard center establishes a reference point for keyboard modulation; keys above this point will have a positive value, while keys below it will be negative. For example, if we wished to change the volume of an instrument using key number and the key center were set to key A1, the instrument would get progressively louder above A1 and progressively softer below A1.

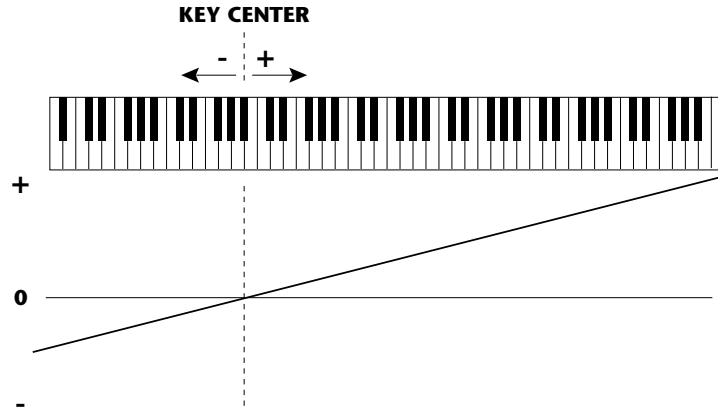

VELOCITY CURVES

Incoming velocity values can be scaled by one of the four velocity curves or by one of the eight Global velocity curves in order to match your playing style or better adapt to the MIDI controller. Experiment with the curves to find the one that works best for your style and MIDI controller.

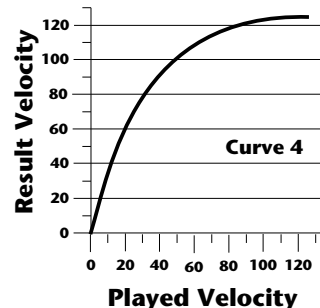
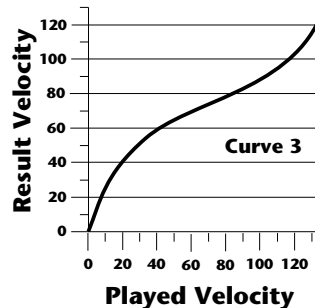
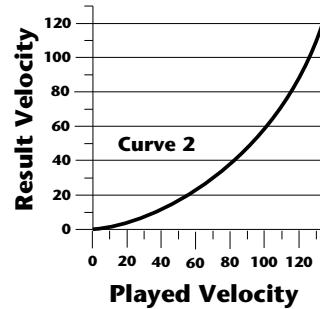
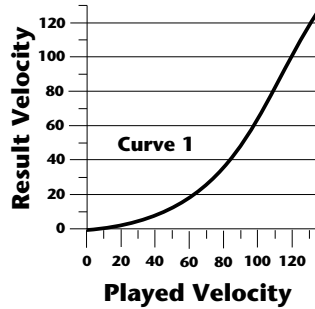

MIDI REALTIME CONTROLS

The MIDI realtime controllers may seem confusing at first, but they are really very simple to understand. You probably already know that there are 16 MIDI channels that can be used. Each of the 16 MIDI channels uses basically 3 types of messages; *note on/off*, *program changes*, and *continuous controller* messages. Your MIDI keyboard, in addition to telling Morpheus which note was played, may also send *realtime control* information, which simply means occurring in real time or live. (You may be using a MIDI device other than a keyboard, but for simplicity's sake we'll presume that you're using a keyboard.) Realtime control sources include such things as pitch wheels or levers, modulation wheels or levers, control pedals, aftertouch, etc. and are used to add more expression or control. Your MIDI keyboard sends out realtime controller information as *continuous controllers*. There is a set of 32 continuous controllers for each of the 16 MIDI channels. Some of the controllers, such as pitch wheel, volume, and pan have standardized numbers. For example, volume is usually sent on continuous controller #7.

••• MIDI wind controllers may work better if you assign one of the MIDI A, B, C, D controllers to control volume. This will allow the MIDI volume to be **added** to the current volume.

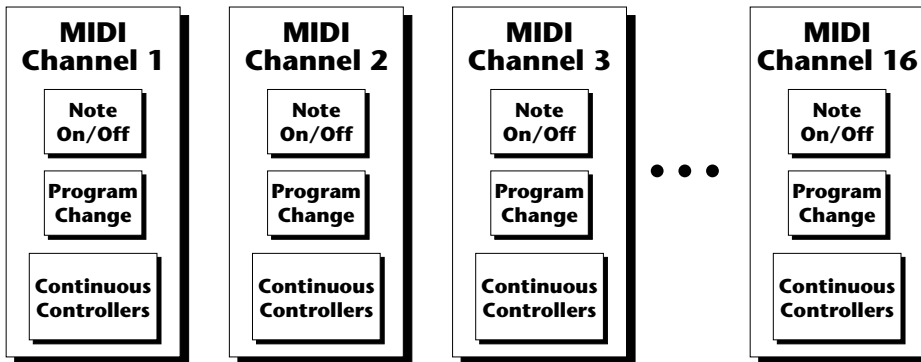

Common realtime controllers such as the pitch wheel, volume, pan and pressure are pre-programmed to their proper destinations. Your keyboard may have other realtime controls such as a control pedal or data slider which can also be programmed to control most of the parameters on Morpheus.

Morpheus is equipped with the sophisticated *MidiPatch™ system*, which allows you to route any continuous controller to any realtime modulation destination. The MidiPatch system is also very easy to use. First, you must know which controller numbers your keyboard can transmit.

Let's say for example, that you are using a Yamaha DX7 as your master keyboard. The DX has pitch and mod. wheels, a breath controller, a data slider and a foot pedal, all of which transmit their values over MIDI. The standard MIDI controller numbers for the controls are listed below (the pitch wheel has a dedicated controller, PWH).

First, we would go to the Master menu, MIDI Controller Assign and define the 4 MIDI controllers that we wish to use. Assign each controller number to one of the letters A-B-C-D.

- 01 - Modulation Wheel A**
- 02 - Breath Controller B**
- 04 - Foot Pedal C**
- 06 - Data Entry D**

To complete the connections for a particular preset, go to the Edit menu, Realtime Modulation Control, and route the MIDI A, B, C, D to the desired destinations. These could be patched to any four destinations or even to the same destination. The MIDI Controller Amount menu, (in the Preset menu) allows you to scale the amounts of each of the controllers by a positive or negative value. The signal flow is shown in the diagram below.

Standard MIDI Controller Numbers

- 1 Modulation Wheel
- 2 Breath Controller
- 3 Pressure (Rev 1 DX7)
- 4 Foot Pedal
- 5 Portamento Time
- 6 Data Entry
- 7 Volume
- 8 Balance
- 9 Undefined
- 10 Pan

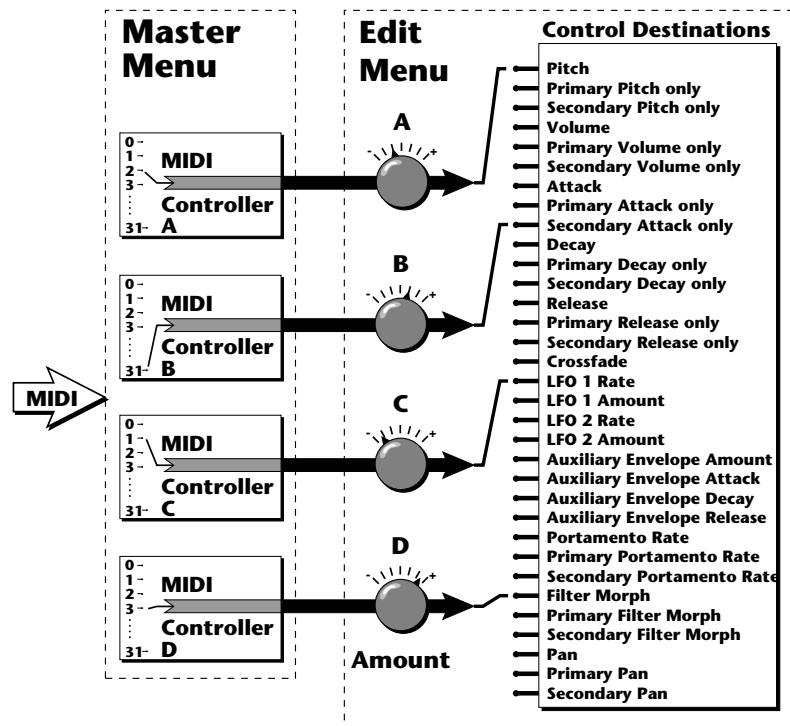

The MIDI controllers A-B-C-D must have both a source (0-31), and a control destination assigned.

PRESET MENU



The Preset menu contains functions that can be modified by the user and then saved as preset information in one of the user presets. For example, the LFO speed or other parameter can be edited, then the preset can be saved to a user location (0-127, bank 0).

WARNING

Changes made in the Preset menu will be forever lost unless the preset is "saved" using the Save Preset function (page 127) before changing the preset.

To enable the Preset menu

Press the Preset button, lighting the LED. The current screen will be the one most recently selected since powering up the machine. The cursor will appear underneath the first character of the screen heading on line one.

To select a new screen

Press the Home/Enter button or press a cursor button repeatedly until the cursor is underneath the screen title heading. Rotate the data entry control to select another screen.

To modify a parameter

Press the cursor button repeatedly (or hold the right cursor button while turning the data entry control) until the cursor is underneath the parameter value. Rotate the data entry control to change the value.

To compare an edited preset with the original preset

Press the preset button, turning off the LED. The unedited preset is now active. *Changing the preset number will erase the edit.* To hear the edited preset again, press the Preset button, lighting the LED. The stored version of the preset will be heard whenever you are in the main screen.

To return to the main screen

Press the Preset button, turning off the LED.

●●● *While the Preset menu is activated, incoming MIDI preset changes are ignored. This is a quick and easy way to temporarily turn MIDI Program Change OFF.*

▼ *Compare Mode must be turned On in the Master Menu for the Compare feature to work.*

PRESET MENU FUNCTIONS

- **Preset Name**

Preset Name allows you to name each of the user presets with a name of up to 12 characters. Position the cursor under the character location and use the data entry control to change the character. The keyboard can also be used to select characters. The chart below shows the keyboard character assignment.

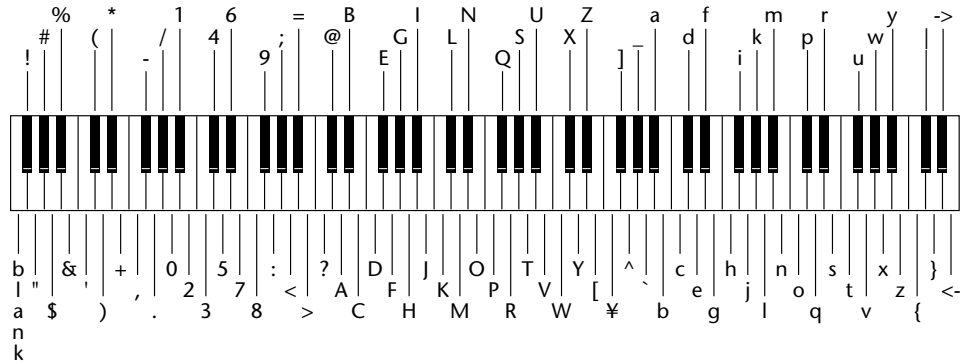
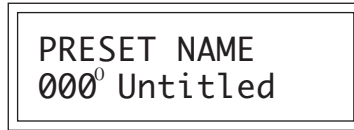

- **Primary Instrument**

This function allows you to select which of the available instrument sounds (or none) will be placed on the primary layer of the current user preset.



- **Secondary Instrument**

This function allows you to select which of the available instrument sounds (or none) will be placed on the secondary layer of the current user preset.



••• *Changing the instrument is a simple way to create a new sound while retaining all other parameters of the preset.*

- **Volume**

Volume sets the amplitude of the primary and secondary instruments. This function also allows you to compensate for the relative volume differences between instruments.

```
VOLUME
pri:127  sec:64
```

- **Pan**

Pan allows you to independently set the initial pan position of the primary and secondary instruments. A value of -7 pans the instrument hard left and a value of +7 pans the instrument hard right. This pan setting is only valid if "P", for preset pan, is selected in the main display (or the Midimap).

```
PAN
pri:-7  sec:+7
```

- **Key Range**

Key range sets the keyboard range of both primary and secondary instruments. This sets the keyboard range for the entire preset and will further limit the primary and secondary keyboard ranges. The key range can be set anywhere from C-2 to G8.

```
KEY RANGE
C-2 -> G8
```

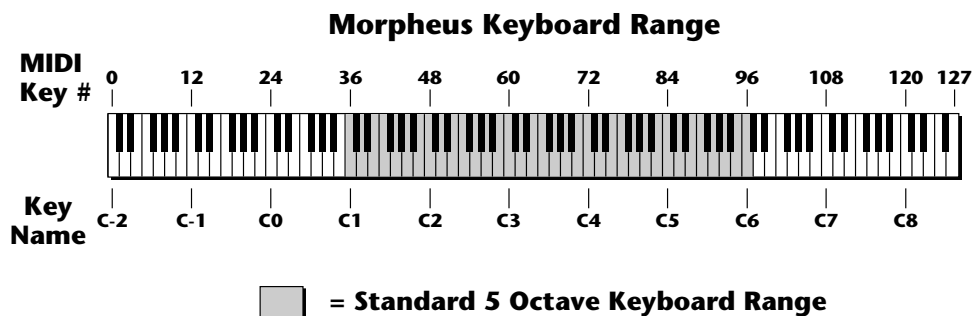

- **Primary Key Range**

Key range sets the keyboard range of the primary instrument. This is useful for creating positional crossfades and keyboard splits between the primary and secondary layers. The key range can be set anywhere from C-2 to G8.

```
KEY RANGE pri
C-2 -> G8
```

- **Secondary Key Range**

Key range sets the keyboard range of the secondary instrument. The key range can be set anywhere from C-2 to G8.

```
KEY RANGE sec
G#4 -> G8
```

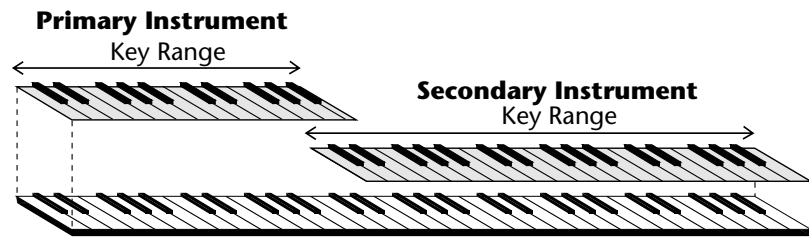

SPLIT KEYBOARD

This diagram shows how a “split” keyboard can be programmed using the primary and secondary instruments.

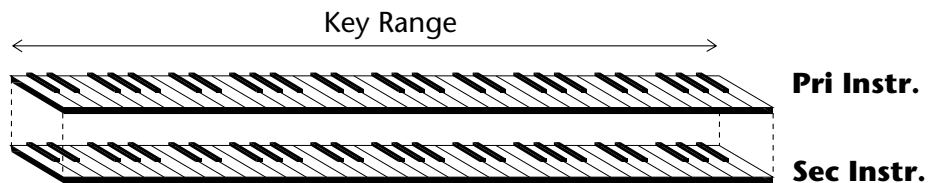

LAYERING TWO INSTRUMENTS

This diagram shows how instruments can be layered or “stacked” using the primary and secondary instruments.

••• Entire presets can also be combined to form split or layered keyboards. See the chapter on Hyperpresets in this manual.

- **Transpose**

This function allows you to transpose the key of the primary and secondary instruments in semitone intervals by shifting the keyboard position relative to middle C. The transpose range is -36 to +36 semitones.

```
TRANPOSE
pri:+00  sec:+00
```

- **Coarse Pitch Tuning**

This function allows you to change the tuning of the primary and secondary instruments in semitone intervals. The coarse tuning range is -36 to +36 semitones.

```
PITCH TUNE crse
pri:+00  sec:+00
```

- **Fine Pitch Tuning**

This function allows you to change the tuning of the primary and secondary instruments in 1/64 semitone intervals (approx. 1.56 cents). The fine tuning range is ± 1 semitone.

```
PITCH TUNE fine
pri:+00  sec:+00
```

- **Alternate Volume Envelope On/Off**

Each instrument has its own factory preset AHDSR volume envelope which is used if this parameter is set to Off. Turn Alternate Volume Envelope On to use the user-programmable alternate envelope.

```
ALT VOL ENVELOPE
pri:Off  sec:0n
```

••• Use Transpose when you want the instrument's timbre to remain constant.

Use Coarse Tuning when you want to change the timbre of the instrument.

••• Use the Coarse Tuning control to change the tuning of multiple drum instruments.

••• See pages 73-74 for an explanation of the envelope parameters.

••• Shortening the attack and release times of the Alternate Envelope can alleviate channel “ripoff” problems. Morpheus examines the Alternate Envelope to determine if a channel can be reused.

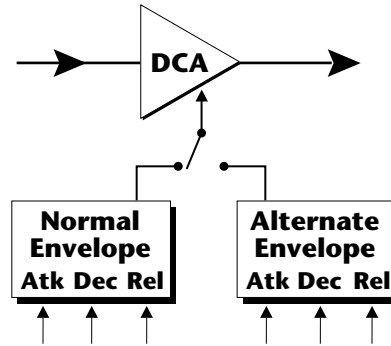

• Primary Alternate Envelope Parameters

This function allows you to adjust the alternate volume envelope parameters for the primary instrument. The parameters are Attack time, Hold time, Decay time, Sustain level, Release time and are adjustable from 00 to 99.

P:	A	H	D	S	R
	00	00	00	99	16

• Secondary Alternate Envelope Parameters

This function allows you to adjust the alternate volume envelope parameters for the secondary instrument. The parameters are Attack time, Hold time, Decay time, Sustain level, Release time and are adjustable from 00 to 99.

S:	A	H	D	S	R
	00	00	00	99	16

• Double + Detune

Double + Detune “thickens” the sound by doubling the sound and then detuning it. The amount is variable over a range of 1 to 15. When Double + Detune is on, a particular instrument will use twice as many channels. If Double + Detune is used for both the primary and secondary instruments, the preset will use four channels per key.

DOUBLE + DETUNE	
pri:Off	sec:07

- **Sound Delay**

Sound Delay varies the time between the arrival of a MIDI Note-On message and the onset of a note. The delay time is adjustable from 0 to 14 seconds (000-127).

```
SOUND DELAY
pri:000  sec:000
```

- **Sound Start**

This function allows you to set where a sample begins playing when you hit a key. A setting of 000 plays a sound from the beginning, higher values move the sample start point toward the end of the sound.

```
SOUND START
pri:000  sec:000
```

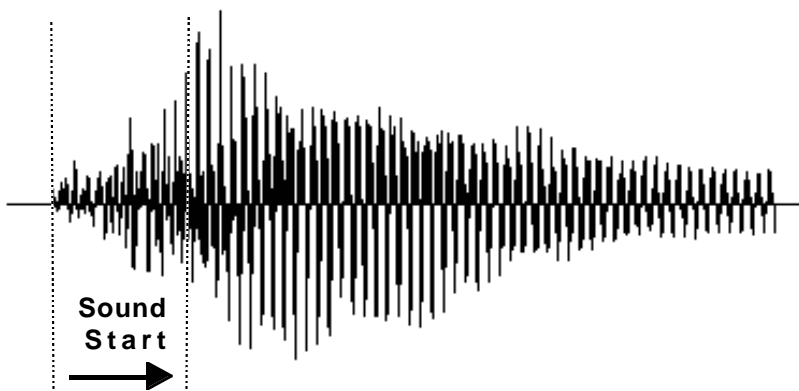

The Sound Start parameter allows you to cut off the beginning of the sound. Higher values move the start point toward the end of the sound.

- **Sound Reverse**

When sound reverse is turned On, the instrument will be played backwards. Since instruments tend to sound very different when reversed, this function extends the number of possible sounds in Morpheus.

```
SOUND REVERSE
pri:0ff  sec:0n
```

••• See the Step-By-Step section of this manual for an application using Sound Start.

••• The Sound Start parameter can be useful to remove the gradual attack of a reversed sound. The Loop Offset parameters can also be put to good use with reversed sounds.

• **Nontranspose**

This function turns keyboard transposition On or Off for the primary and secondary instruments. With Nontranspose On, the keyboard will not control the pitch of the instrument. This is a useful function for drones or “chiffs”, which you may not want to track the keyboard.

```
NONTRANSPOSE
pri:0ff  sec:0n
```

• **Loop Enable**

This function allows you to turn the loop in a sound On or Off. Looping is a way that sounds can be sustained indefinitely. If you want an instrument to play once, then stop, turn Off the Loop Enable function.

```
LOOP ENABLE
pri:0ff  sec:0n
```

• **Loop Offset**

All the Morpheus instruments have been factory looped for your convenience. The Loop Offset function allows you to modify the Loop Start Point and the Loop Size so you can create your own loops.

By looping the sound on the attack portion of an instrument, you can create new waveforms. The Loop Start and Loop Size parameters can cross sample boundaries so that more than one instrument will play. Sample boundary crossing may be useful to create a special effect or background ambience. A Start and Size Offset of 000,000 returns you to the factory loop setting.

LOOP OFFSET IDEAS

••• Loop offset can be used to create interesting new timbres by looping on the attack transient of an instrument.

••• By traversing several instruments you may find interesting polyrhythms.

••• Extremely LONG loop sizes can create incredible background ambience. Use pitch-shifting and multiple keys.

Primary

```
LOOP OFFSET
StartP +000,000
```

```
LOOP OFFSET
SizeP +000,000
```

Secondary

```
LOOP OFFSET
StartS +000,000
```

```
LOOP OFFSET
SizeS +000,000
```

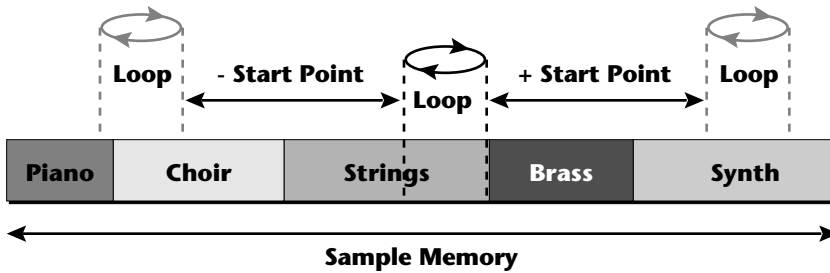

Changing the Loop Offset Start point moves the loop forward or backward (+ or-) through the sample memory, keeping the loops size constant. Large changes will move the loop completely out of the original sample.

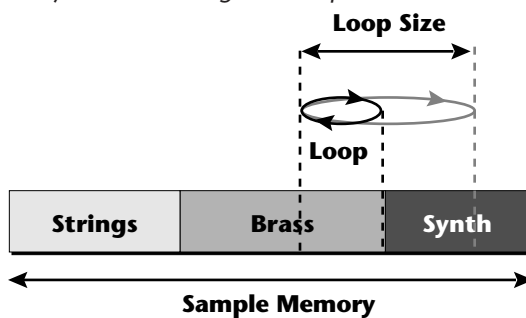

Changing the Loop Offset Size alters the size of the loop, leaving the loop start point stationary. Large positive offsets will enlarge the loop to encompass multiple samples.

• **Solo Mode**

Solo mode provides the playing action of a monophonic instrument. It can make wind and string instruments sound more realistic by preventing more than one note from sounding at once. Two types of solo mode are provided: *Wind Controller* mode and *Synth* mode. In either solo mode, if a new note is played while another is being held, the envelope generators do not retrigger and the sample remains in the loop. This allows a legato playing technique to be used.

Wind Mode

The envelope generator attack always begins at the start of the attack phase when playing staccato. When playing legato, the envelope generator stays in the sustain phase.

Synth Mode

The envelope generator attack begins at whatever point in the release phase is in when a new key is pressed. When playing legato, the envelope generator stays in the sustain phase.

```
SOLO MODE
p:Off    s:Wind
```

••• Sounds are looped so that they will continue to sound as long as the key is held.

••• When using a negative loop start point, the sound may jump back to a point before the start of the sample during the loop cycle.

••• Solo Mode allows you to simulate certain playing techniques such as "Tongueing" on a saxophone, where the attack is only heard on certain notes.

▼ There is a four note limit for remembering notes in the First and Last Note Priority modes.

• Solo Mode Priority

When multiple notes are played and held in solo mode, the last note played is always heard. As notes are released, the solo mode priority determines which note will take over from the last note played.

- **High Note Priority** - If multiple notes are being held in solo mode, the highest key being held will play when the last-played key is released.
- **Low Note Priority** - If multiple notes are being held in solo mode, the lowest key being held will play when the last-played key is released.
- **First Note Priority** - If multiple notes are being held in solo mode, and the last note is released, the note will jump back to the first note.
- **Last Note Priority** - If multiple notes are being held in solo mode, only the note last pressed will play. If the note is released it jumps back to the last note before that.
- **Drum** - If multiple notes are being held in solo mode, only the note last pressed will play. If the note is released, no jumping occurs.

```
SOLO PRIORITY
p:Low    s:Hi
```

• Portamento Rate

Portamento is a smooth gliding between notes instead of the normal instantaneous change in pitch when a new key is pressed. The portamento rate is the time it takes to glide to the new pitch. The larger the value, the slower the glide rate. The rate is adjustable from 1-127 or it can be turned Off. Portamento glides at a linear rate between notes and can be set separately for the primary and secondary layers. Portamento works both in and out of Solo Mode.

```
PORTAMENTO RATE
pri:127  sec:Off
```

• Portamento Shape

The portamento is variable from convex exponential (8) to linear, for both the primary and secondary instruments. Using the exponential shapes, the portamento rate will slow as the note nears its destination.

```
PORTAMENTO SHAPE
pri:Ex4  sec:Lin
```

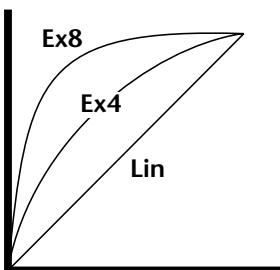

The portamento shape can be varied from linear to convex exponential.

• **Portamento Mode**

This function sets the number of notes that will be affected by portamento. For example, if the Portamento Mode is set to two keys and a three-note chord is played, only two of the notes will glide. Notes will glide from the previous note or notes played. By setting the number of keys to match the number of notes in your chords, smooth glides between those chords can be accomplished without having notes glide in from random starting points. The number of keys can be set from mono to 5 note polyphonic.



• **Crossfade Mode**

This function determines which of the following crossfade modes will be selected: Off, Crossfade, or Cross-Switch.

Off

When “Off” is selected, crossfade is disabled.

Crossfade

When “X-Fade” is selected, a control input is used to fade between the primary and secondary instruments. Any modulation source may be used as an input (velocity, wheel, etc.).

Cross-Switch

When “X-Switch” is selected, the secondary layer is selected if the input crosses a certain threshold or if a footswitch controlling cross-switch is activated. The switch occurs only at the start of the note; no further switching takes place while the key is held down. If key position or velocity is routed to cross-switch, the threshold is the *switch point*. Realtime controllers do not have any effect when routed to cross-switch.

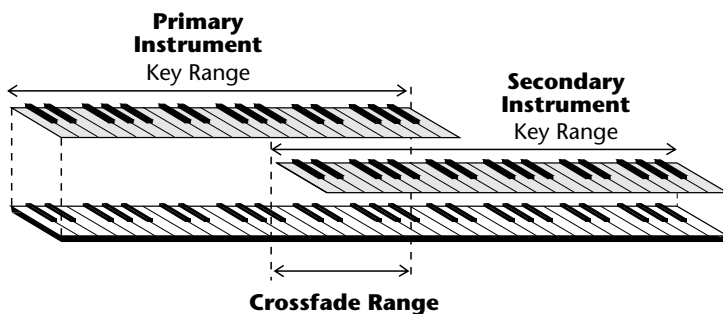
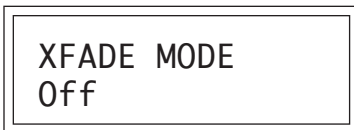

By overlapping the primary and secondary instruments, you can crossfade or cross-switch between the layers.

▼ To enable the crossfade or cross-switch functions, you must assign **Crossfade** to a modulation source in the Realtime or Note-On Modulation screen.

••• See also, Cross-Switch Point on page 113.

••• To use the keyboard for crossfade, set the Crossfade Balance to 64 and the Key Center to the split point.

• **Crossfade Direction**

This function determines the polarity of the crossfade or cross-switch. The direction is either primary → secondary, or secondary → primary.



• **Crossfade Balance and Amount**

The crossfade balance parameter determines the initial balance between the primary and secondary layers. Higher values shift the balance to the secondary instrument. When the Crossfade Direction is Pri->Sec, Modulation subtracts from the primary volume and adds to the secondary volume. When crossfade modulation and balance equal 64, the two instruments are at equal volume.

The crossfade amount parameter determines the range over which crossfading will occur. Crossfade amount is variable from 000 to 255. The larger the value, the more modulation will be required to effect a complete crossfade.

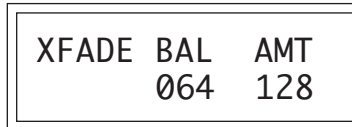

••• A Crossfade Balance setting of 000 would be appropriate with a source such as a modulation wheel or footpedal, either of which can only change the value in a positive direction.

▼ In order to use the Crossfade or Cross-Switch functions, you must assign Crossfade to a modulation source in the Realtime or Note-On modulation screens.

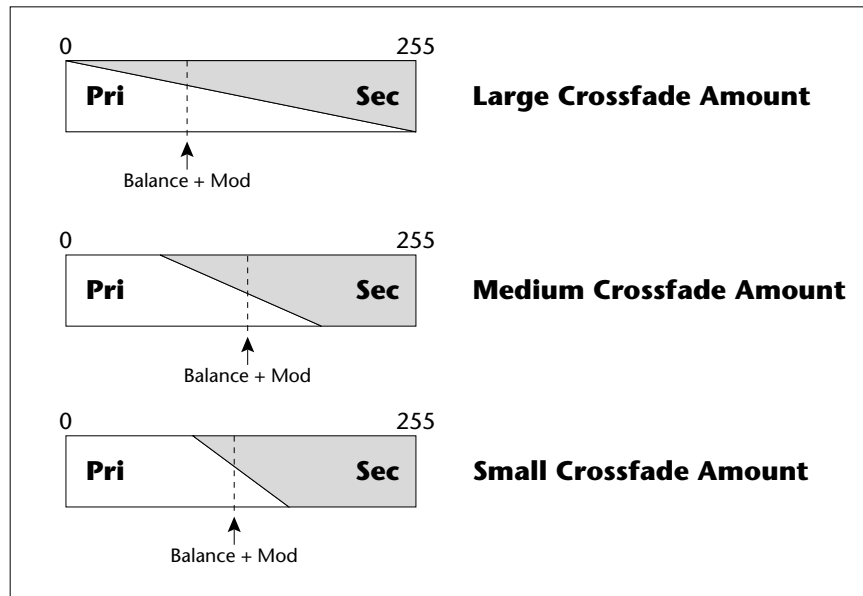

Modulation and Crossfade balance are **added** together to determine the mixture of primary and secondary instruments. Higher values increase the secondary volume.

• **Cross-Switch Point**

The cross-switch point determines the point at which cross-switching will occur when key position or velocity is controlling cross-switch.

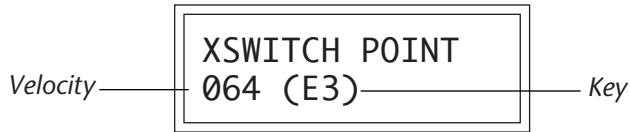

• **Primary Filter Type**

This screen allows you to select one of 197 Z-Plane filter types available in ROM. These filters include: traditional low-pass filters, flanger simulators, vowel formants, distortion filters, acoustic instrument models and many, many more. See the reference section for a complete listing and descriptions of the filters.

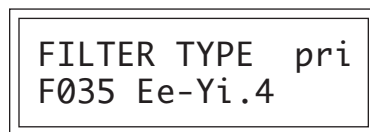

• **Secondary Filter Type**

This screen allows you to set the filter type for the secondary layer. See Primary Filter Type.



• **Filter Level**

This function sets the amount of signal into the filter. This control can be used to balance the levels between instruments or to control the distortion characteristics of the filter. Depending on the type of instrument and the filter, this control can have a dramatic effect on the sound. This control differs from the Volume parameter which adjusts the volume *after* the filter. The default setting is 255 (full level).



▼ To enable the Cross-switch function, you must assign **Crossfade** to a modulation source in the Note-on or Realtime Cords screens.

▼ Under certain unusual circumstances the filters may overload, producing a loud objectionable noise. Turn down the Filter Level value to alleviate the problem.

• **Morph Offset**

This function allows you to set the initial point in the filter morph with no modulation applied. Subsequent modulation will be added or subtracted to this value.

MORPH OFFSET
pri:096 sec:000

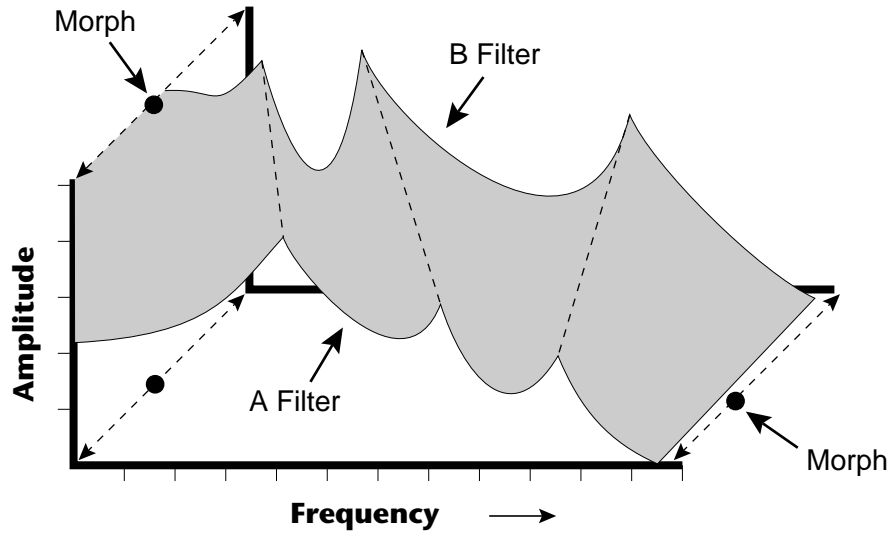

The Morph Offset sets the point along the morph axis where the filter starts with no modulation applied.

• **Filter Frequency Tracking**

If the filter frequency remains constant as the pitch of a sound is varied, the timbre of the sound will change with pitch. A way to correct this is to have the filter's frequency track the pitch of the note. **This function sets the initial frequency of the filter's pitch tracking.** In general, you can think of frequency tracking as a tone control. In order to have keyboard tracking, you must also patch the "Keyboard to Filter Frequency Tracking" in the Note-On modulation screen.

FILT FREQ TRACK
pri:000 sec:000

••• In many of the filters, the Filter Frequency Tracking works like a tone control which brightens or darkens the sound.

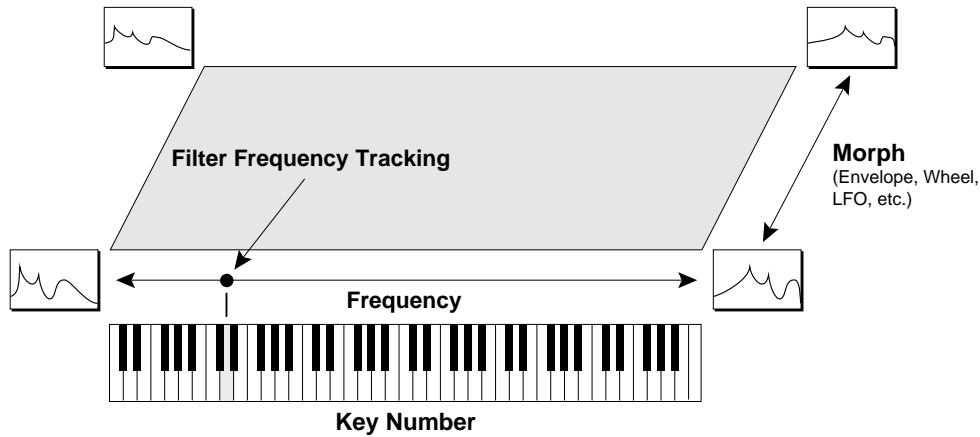

Filter Frequency Tracking allows the timbre of the sound to remain constant up and down the keyboard (if Key Number is routed to this parameter).

• **Filter Transform 2**

Suppose we added yet another dimension to the filter model. We have the realtime *Morph* parameter, the *Frequency Tracking* parameter (set at note-on time) and one more parameter, perhaps controlling the amount of the filter peaks with key velocity. A way to visualize a three-dimensional filter model is shown in the diagram below.

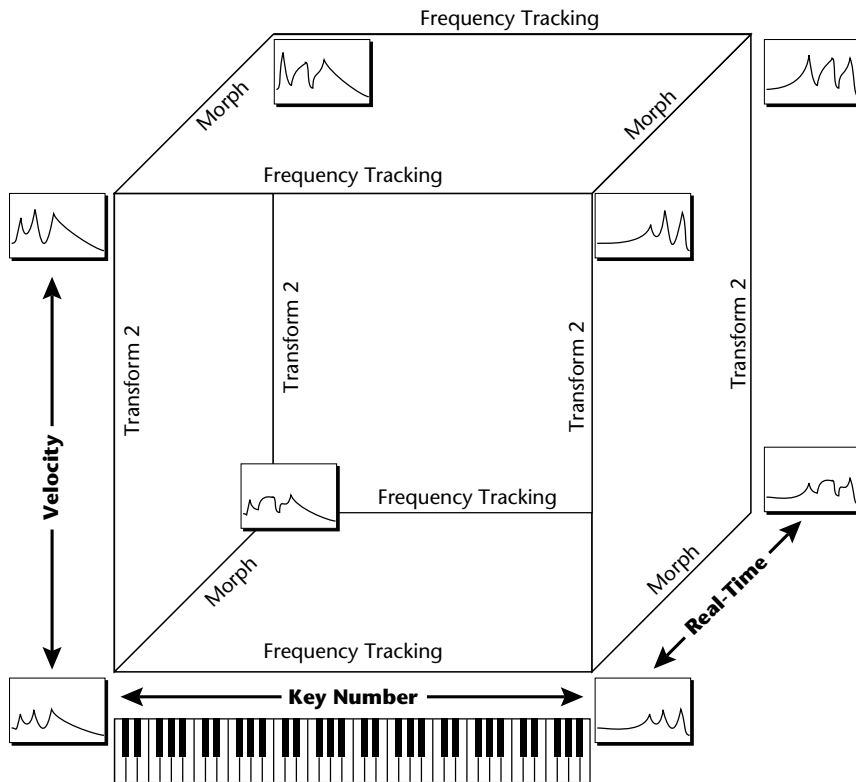

Each Morpheus filter is actually constructed of up to eight different complex filters.

••• The filters labeled with ".4" in their name do not use the Transform 2 parameter.

Each axis of the three-dimensional cube changes the filter in a different way. In the example above, key number is being applied to the Frequency Tracking parameter in order to make the filter frequency track or follow the notes played on the keyboard.

In the 3-D filter model, there is another note-on (*defined at the time the note is pressed*) parameter, Transform 2. Unlike the frequency tracking parameter, the effect of Transform 2 varies from filter to filter. In the example above, Transform 2 is being used to vary the size of the peaks and notches in the filter. The frequency plots in the upper plane of the cube have sharper peaks. In the example above, key velocity is being used to control Transform 2 and the sharpness of the filter peaks.

Filter Transform 2 sets the **Initial Point** along the Transform 2 axis. Subsequent modulation (from note-on modulation) adds to this initial setting for the primary and secondary filters.

```
FILT TRANSFORM 2
pri:000  sec:127
```

• Filter Reverse

This function allows you to reverse the direction of all of the filter controls. Key Tracking, Transform 2 and the Morph parameters will all operate in reverse. The Offset points are reversed, as well as the direction of filter modulation.

```
FILTER REVERSE
pri:0ff  sec:0ff
```

• Auxiliary Envelope

This is a supplementary, utility envelope that can be routed to any realtime control destination including the Morph filter. The auxiliary envelope parameters are: Envelope Amount, Delay, Attack Time, Hold Time, Decay Time, Sustain Level, and Release Time. The delay time is variable from 0 to 13 seconds (000-127). The envelope amount is variable from -128 to +127. Negative values will produce inverted envelopes.

••• For more information on the Envelopes, see the Preset Programming section of this manual.

```
AUX ENV  AMT DLY
          +127 000
```

```
A:  A  H  D  S  R
    00 00 00 99 20
```

• **LFO 1 - Shape & Amount**

This screen controls the waveshape and amount of Low Frequency Oscillator 1. The LFO can be used to produce vibrato (when routed to pitch), or tremolo (when routed to volume). The LFO can be routed to control any of the Realtime Modulation destinations (page 123). The five LFO waveshapes are: Triangle, Sine, Square, Sawtooth, and Random. The amount can be varied from -128 to +127. Negative values will produce inverted waveshapes.



••• For more information on the LFOs, see the Preset Programming section of this manual.

• **LFO 1 - Rate, Delay & Variation**

This screen controls the rate, delay and variation of LFO 1.

LFO Rate

Varies the LFO speed from 0.052 Hz to 25 Hz (000-127).

LFO Delay

Sets the amount of time between hitting a key and the onset of modulation. This can be used to simulate an effect often used by acoustic instrument players, where the vibrato is brought in only after the initial note pitch has been established. The delay range is variable from 0 to 13 seconds (000-127).

LFO Variation

Sets the amount of random variation of an LFO each time a key is pressed. This function is useful for ensemble effects, where each note played has a slightly different modulation rate. The higher the number, the greater the note to note variation in LFO rate. LFO variation is variable from 000-127.

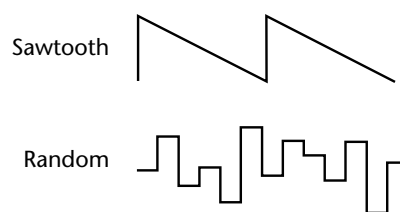
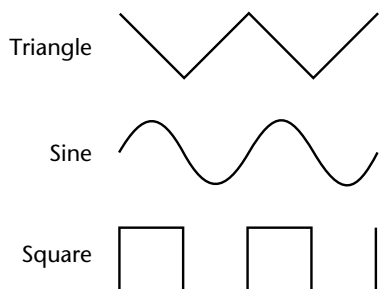
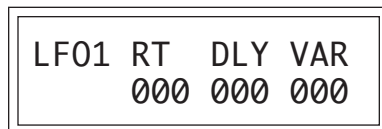

• **LFO 2 - Shape & Amount**

LFO 2 is functionally identical to LFO 1.

• **LFO 2 - Rate, Delay & Variation**

LFO 2 is functionally identical to LFO 1.

• **Function Generators 1 and 2**

The Function Generators are eight segment modulation sources with conditional jumping capabilities and selectable segment shapes. Level and Time parameters are provided for each stage. In addition, the shape of each stage can be individually selected from a palette of 63 shapes. The function generator can be used when you want complex and precise control over a parameter. Through the creative use of its conditional jumps and curves, the function generator can serve as a complex LFO, a complex envelope generator, a mini-sequencer, a random source or all at once if you desire.

••• For more information on Function Generators, see the Preset Programming section of this manual.

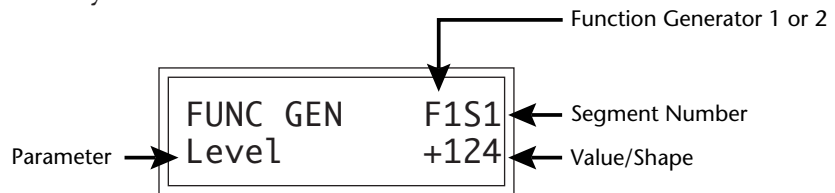

Function Generator Parameters

Level	+127
Time	0750ms
Shape	Linear
CondJump	Never
CondValue	+000
CondDestSeg	2

••• Routing the Function Generator to control Pitch makes it easy to hear what you are doing.

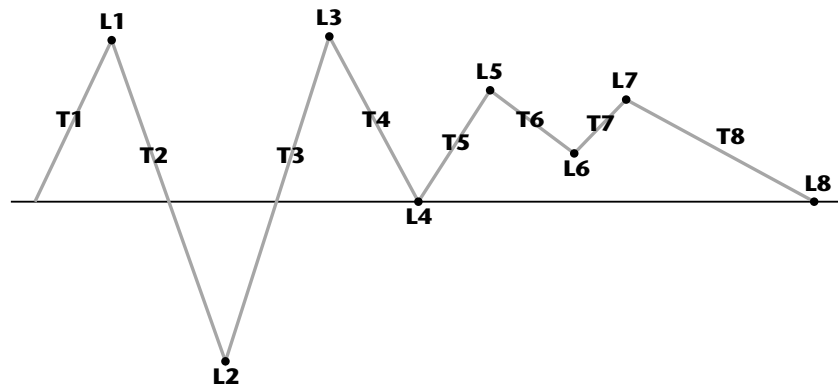

The Function Generator contains eight segments, each with a level and time parameter.

The function generator can have up to eight segments, each with a *Level* and a *Time* parameter. The level parameter can be either positive or negative. Each segment of the function generator can have a different *Shape*. There are 63 different shapes consisting of various curves, straight and crooked line segments, random, chaos and delays.

FUNC GEN	F1S1
Level	+124

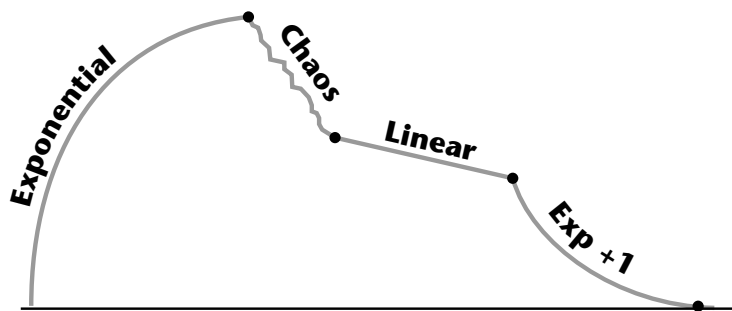

Four of the 63 curves are shown below. By combining the various curve shapes, extremely complex functions can be created. See the Reference Section of this manual for the complete set of function generator curve diagrams.

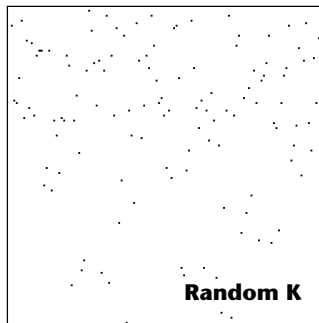
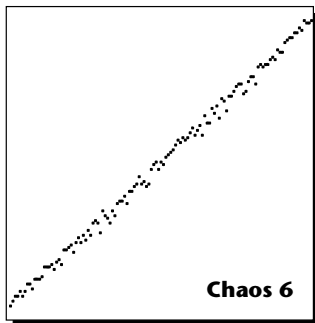
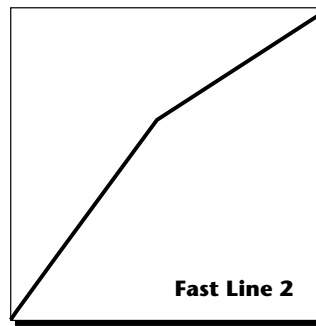
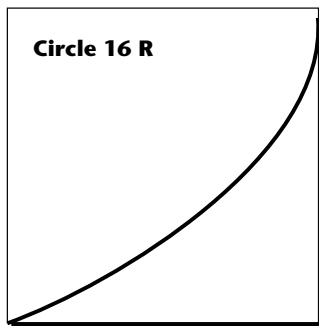

Function Generator Curves

- Linear
- Exponential +1
- Exponential +2
- Exponential +3
- Exponential +4
- Exponential +5
- Exponential +6
- Exponential +7
- Circle 1.4
- Circle 1.6
- Circle 1.8
- Circle 1.16
- Squeeze
- Fast Line 1
- Fast Line 2
- Fast Line 3
- Medium Line 1
- Medium Line 2
- Slow Ramp 1
- Slow Ramp 2
- Bloom
- Bloom 2
- Circle 1.16 Reverse
- Circle 1.8 Reverse
- Circle 1.6 Reverse
- Circle 1.4 Reverse
- Slow Curve 1
- Slow Curve 2
- Delay DC
- DC Delay
- Curve 2x
- Curve 2x B
- Curve 2x C
- Ziz Zag 1
- Ziz Zag 2
- Ziz Zag 3
- Chaos 03, 06, 12, 16, 25, 33, 37, 50, 66, 75, 95, 99
- Linear Shuffle 1
- Linear Shuffle 2
- Random A-L
- Random Z

The function generator can be programmed to jump between segments based on certain conditions. Because the decision to jump is based on conditions, these jumps are called *Conditional Jumps*. For example, the function generator could be programmed to loop only if the key is still being held. In the diagram below, the function generator has been programmed to jump back to segment 3 if the key is held but jump to segment 4 whenever the key is released.

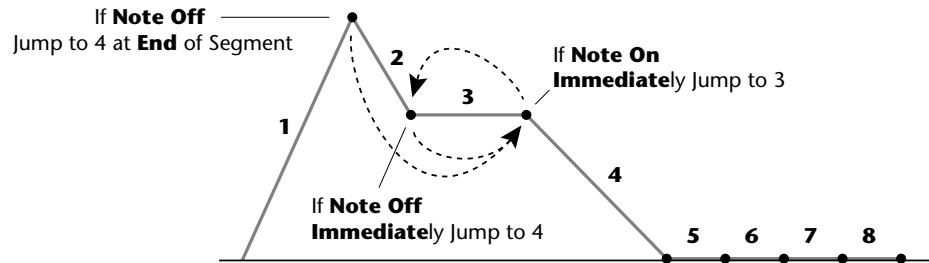

••• A *Conditional Jump* always goes to the *Beginning* of the destination segment.

Conditional jumps can be programmed to jump to the destination segment immediately or they can wait until the end of the segment before jumping. The conditional jumps are:

Never Never jumps. Always goes on to next segment.

Always End Always jumps at the end of the current segment.

Note On End Jumps at the end of the segment if the note is still on.

Note On Immed. Jumps immediately if the note is still on.

Note Off End Jumps at the end of the segment if the note is off.

Note Off Immed. Jumps immediately if the note is off.

LFO 1 or 2 End Jumps at the end of the segment if the value of the selected LFO is equal or greater than the conditional value.

Footsw. 1-3 End Jumps at the end of the segment if the selected footswitch is pressed.

Footsw. 1-3 Immed. Jumps immediately if the selected footswitch is pressed.

Velocity End Jumps at the end of the segment if the velocity value is greater than a positive conditional value or less than a negative conditional value. See the following page.

Key End Jumps at the end of the segment if the note value is greater than a positive conditional value or less than a negative conditional value. See the following page.

▼ Remember to turn up the LFO amount when using LFOs as conditionals.

For Velocity End & Key End

FUNC GEN	F1S1
CondValue	+064

When the value is **Positive**, a jump occurs if the velocity or key number is **Greater** than value shown.

FUNC GEN	F1S1
CondValue	-064

When the value is **Negative**, a jump occurs if the velocity or key number is **Less** than value shown (ignoring the sign).

••• When one segment jumps to another at a different level, a smooth transition is made between the two. The time to the end of the destination segment remains as specified.

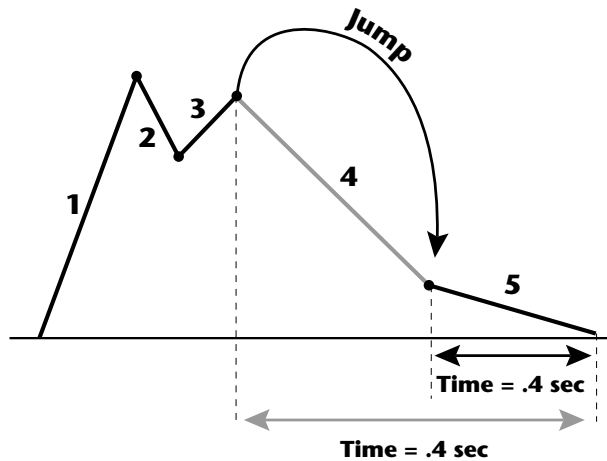

In the example above, segment 4 has been skipped, but the time to the end of segment 5 will remain the same (400 milliseconds). This will alter the slope of segment 5.

• **Function Generator Amount**

This control scales the output of the function generator before it is applied to a modulation destination (in the Realtime Control screen). The amount is like a water faucet. It controls “how much” of the function generator is output. If a negative value is selected, the function generator output will be inverted. Function generator 1 or 2 is selected on the top line of the display (F1 or F2).

FUNC GEN AMT	F1
+064	

••• Drawing your function generator ideas on paper first will simplify the programming process.

••• Remember that you must assign the function generator to a destination in the Realtime Control screen.

••• The Function Generator Amount can also be modulated by a Realtime Control source.

PRESET MENU

Note-On

Modulation Sources

Key Number, Key Velocity
 Initial Pitch Wheel Amount
 Initial Controller A Amount
 Initial Controller B Amount
 Initial Controller C Amount
 Initial Controller D Amount
 Initial Mono Pressure Amount
 Initial FR Function Gen.
 Amount

Destinations

Off
 Pitch, Primary Pitch
 Secondary Pitch
 Volume, Primary Volume
 Secondary Volume
 Attack, Primary Attack
 Secondary Attack
 Decay, Primary Decay
 Secondary Decay
 Release, Primary Release
 Secondary Release
 Crossfade
 LFO 1 Amount, LFO 1 Rate
 LFO 2 Amount, LFO 2 Rate
 Auxiliary Envelope Amount
 Auxiliary Envelope Attack
 Auxiliary Envelope Decay
 Auxiliary Envelope Release
 Function Gen 1 Amount
 Function Gen 2 Amount
 Portamento Rate
 Primary Portamento Rate
 Secondary Portamento Rate
 Filter Morph
 Primary Filter Morph
 Secondary Filter Morph
 Pan, Primary Pan
 Secondary Pan
 Sample Start
 Primary Sample Start
 Secondary Sample Start
 Tone, Primary Tone
 Secondary Tone
 Filter Level, Primary Filter Level
 Secondary Filter Level,
 Filter Freq. Tracking,
 Primary Filter Freq. Tracking
 Secondary Filter Freq. Tracking
 Filter Transform 2
 Primary Filter Transform 2
 Secondary Filter Transform 2

Note-On Modulation Control

These functions allow you to route Note-On information (information received at note-on time such as velocity or key number) to any of the modulation destinations. Up to 10 simultaneous paths or “patches” may be programmed. For each modulation patch, there is a source, a destination and a corresponding amount parameter which is variable from -128 to +127. Place the cursor under the appropriate parameter and change the patch number, modulation source, modulation destination, or the amount, using the data entry control. If a parameter is not labeled either primary or secondary, it affects both.

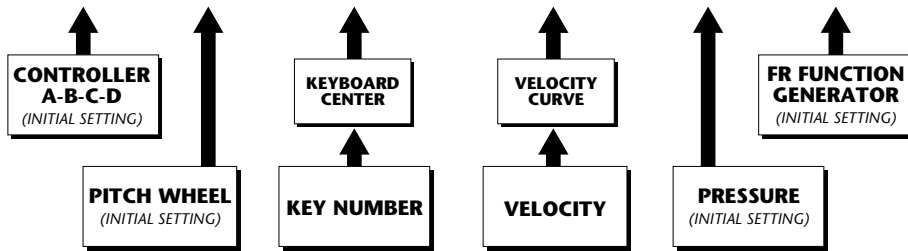
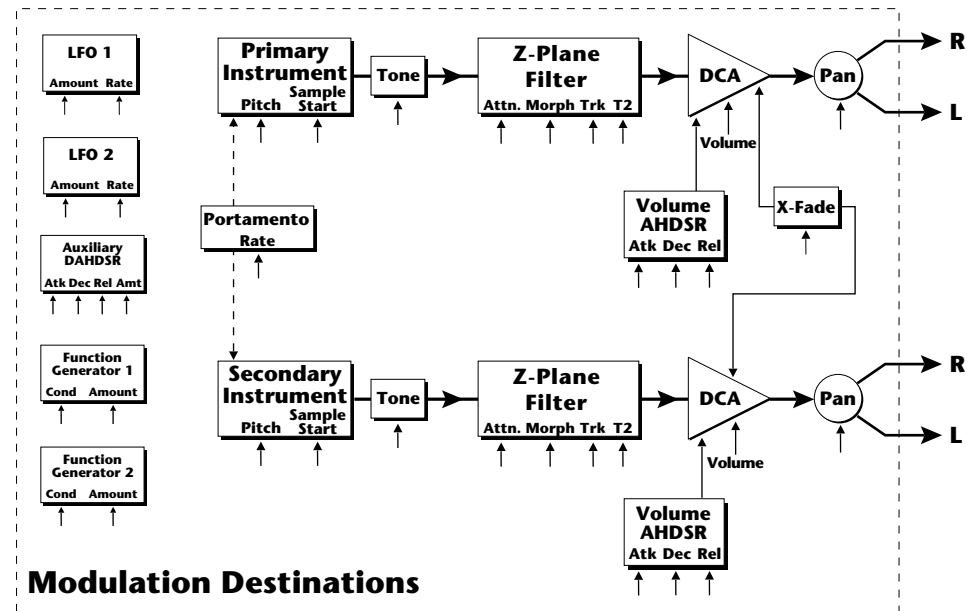
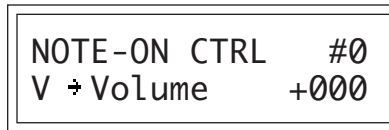

Note-On Modulation Sources

• **Realtime Modulation Control**

These functions allow you to route realtime controllers to any of the modulation destinations except Tone, Sample Start, Filter Frequency Tracking and Filter Transform 2. Up to 10 simultaneous patches may be programmed. For each modulation patch, there is a source and a destination parameter. Place the cursor under the appropriate parameter and change the patch number, modulation source, modulation destination, or the amount using the data entry control. If a parameter is not labeled either primary or secondary, it affects both.

REALTIME CTL #0
PWhl ÷ Off +127

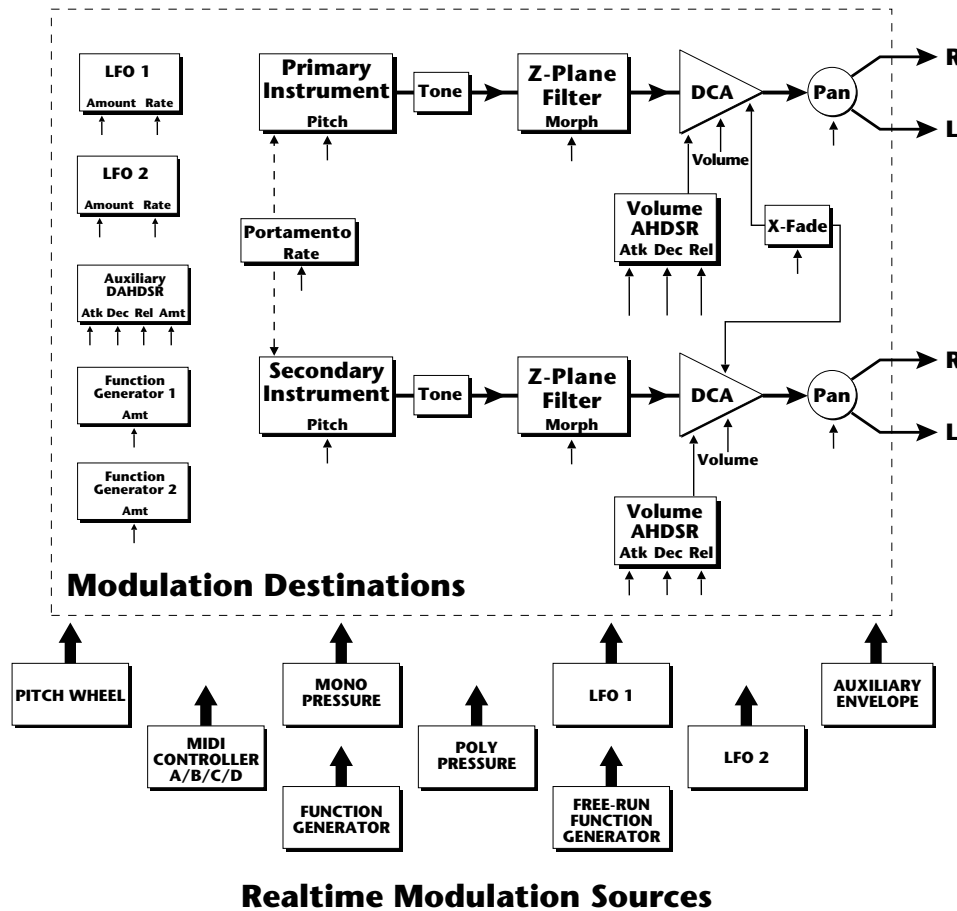

Realtime Modulation Sources

- Pitch Wheel
- MIDI Control A
- MIDI Control B
- MIDI Control C
- MIDI Control D
- Mono Pressure
- Polyphonic Pressure
- LFO 1, LFO 2
- Auxiliary Envelope
- Function Generator 1
- Function Generator 2
- Free-Run Function Generator

Destinations

- Off
- Pitch, Primary Pitch
- Secondary Pitch
- Volume, Primary Volume
- Secondary Volume
- Attack, Primary Attack
- Secondary Attack
- Decay, Primary Decay
- Secondary Decay
- Release, Primary Release
- Secondary Release
- Crossfade
- LFO 1 Amount, LFO 1 Rate
- LFO 2 Amount, LFO 2 Rate
- Auxiliary Envelope Amount
- Auxiliary Envelope Attack
- Auxiliary Envelope Decay
- Auxiliary Envelope Release
- Function Gen 1 Amount
- Function Gen 2 Amount
- Portamento Rate
- Primary Portamento Rate
- Secondary Portamento Rate
- Filter Morph
- Primary Filter Morph,
- Secondary Filter Morph
- Pan, Primary Pan
- Secondary Pan

When Modulating Envelope Attack, Decay or Release Times:

Positive amounts of modulation **increase** the time.
Negative amounts of modulation **decrease** the time.

• **Footswitch Control**

This function allows you to route the 3 footswitch controllers (1, 2 or 3) to any of the footswitch destinations. The footswitches can be routed to switch: Sustain (pri/sec/both), alternate volume envelope (pri/sec/both), alternate volume release (pri/sec/both), cross-switch between the primary and secondary instruments or switch portamento Off or On (pri/sec/both).

FOOTSWITCH CTRL
1 -> Sustain

• **Pitch Bend Range**

This function allows you to specify the pitch wheel range for the current preset if pitch bend is not being globally controlled in the Master menu. Pitch bend range is only used when the pitch wheel is used to control pitch.

PITCH BEND RANGE
+- 12 semitones

• **Pressure Amount**

This function allows you to specify an overall amount parameter for mono or poly keyboard pressure data (pre-patch cord). The pressure amount is variable from -128 to +127.

PRESSURE AMOUNT
+127

• **MIDI Controller Amount**

This function allows you to specify an overall amount parameter (pre-patch cord) which variable from -128 to +127 for each of the MIDI controllers.

CONTROLLER AMT
A:+127 B:+127

CONTROLLER AMT
C:+127 D:+127

▼ *Pressure Amount and Controller A-B-C-D Amount are **MASTER Controls** which affect the amount of modulation which can be programmed in the Realtime Modulation section.*

In order for the Realtime Modulation Control amounts for these functions to have a full range of control, the Pressure and Controller A-D amounts must be set to +127.

• **Velocity Curve**

Incoming velocity data can be modified by a velocity curve in order to provide different types of dynamics in response to your playing or better adapt to the MIDI controller. This function allows you to select one of the four velocity curves or leave the velocity data unaltered (Off). In addition, the velocity curve can be set to “Global”, which means that the global velocity curve (programmed in the Master menu) is used.

VELOCITY CURVE
Global

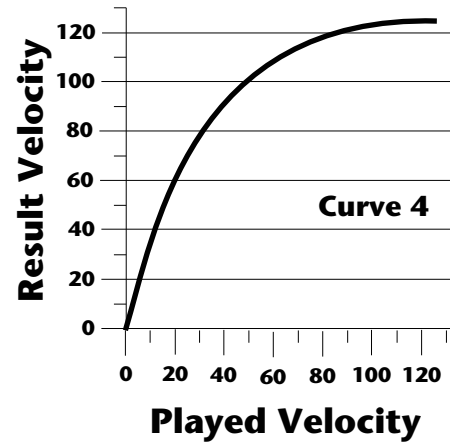
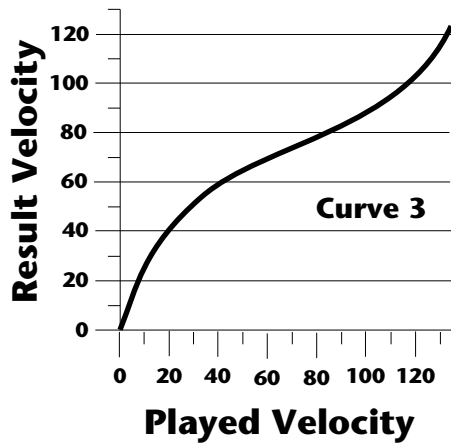
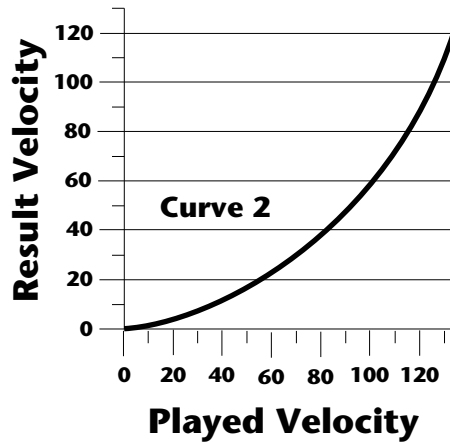
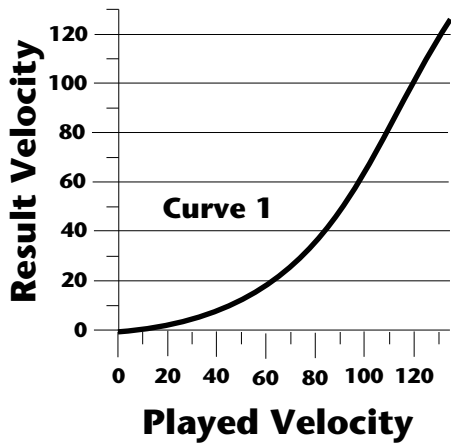

• **Keyboard Center**

The Keyboard Center parameter establishes a reference point for keyboard modulation. Keys above this point will have a positive value and keys below it will be negative. The keyboard center can be set to any key within the range C-2 to G8.

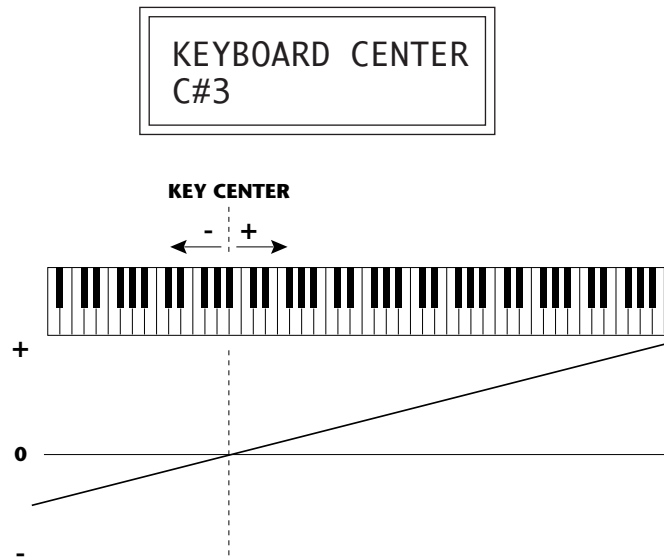

• **Keyboard Tuning**

In addition to the standard equally divided octave tuning, Morpheus contains four other types of scale tuning and one user-definable tuning. This function selects which tuning will be used in the current preset.

The choices of keyboard tunings are:

Equal tuning (12 tone equal temperament)

Standard Western tuning.

Just C tuning (just intonation)

Based on small interval ratios. Sweet and pure, non-beating intervals.

Vallotti tuning (Vallotti & Young non-equal temperament)

Similar to 12 tone equal temperament. For a given scale, each key has a different character.

19 Tone tuning (19 tone equal temperament)

19 notes per octave. Difficult to play, but works well with a sequencer.

Gamelan (Javanese) tuning (5 tone Slendro and 7 tone Pelog)

Pelog-white keys, Slendro-black keys. Exotic tunings of Gamelan flavor.

User tuning

Defined in the Master menu.

- **Mix Select**

This function allows you to direct a particular preset to one of the four destinations (Main, Sub 1, FXA, FXB). This routing is utilized if Mix Select for a particular MIDI channel is set to "Preset" in the current Midimap. Otherwise this setting is ignored. This function allows you to choose the effect bus in the preset rather than by MIDI channel.



MIX OUTPUT
Main

- **Save Preset**

Changes made to a preset in the Preset Edit menu are not made permanent until the preset is *Saved*. To save a preset, move the cursor to the bottom line and select the location for the new preset with the data entry control. The Enter LED will then flash. Pressing the Enter button will confirm the operation.

Any user preset (000-127, bank 0) or RAM card location (000-127, bank 3) may be selected using the data entry control. Writing to a user preset erases the existing preset in that location. Make sure that the destination preset does not contain information that you want to keep.



SAVE PRESET to
064° Preset Name

▼ *In order for the Preset Mix Select to be utilized, the Midimap Mix select must be set to "Preset".*

PRESET MENU



The Preset menu contains functions that can be modified by the user and then saved as preset information in one of the user presets. For example, the LFO speed or other parameter can be edited, then the preset can be saved to a user location (0-127, bank 0).

WARNING

Changes made in the Preset menu will be forever lost unless the preset is "saved" using the Save Preset function (page 127) before changing the preset.

To enable the Preset menu

Press the Preset button, lighting the LED. The current screen will be the one most recently selected since powering up the machine. The cursor will appear underneath the first character of the screen heading on line one.

To select a new screen

Press the Home/Enter button or press a cursor button repeatedly until the cursor is underneath the screen title heading. Rotate the data entry control to select another screen.

To modify a parameter

Press the cursor button repeatedly (or hold the right cursor button while turning the data entry control) until the cursor is underneath the parameter value. Rotate the data entry control to change the value.

To compare an edited preset with the original preset

Press the preset button, turning off the LED. The unedited preset is now active. *Changing the preset number will erase the edit.* To hear the edited preset again, press the Preset button, lighting the LED. The stored version of the preset will be heard whenever you are in the main screen.

To return to the main screen

Press the Preset button, turning off the LED.

●●● *While the Preset menu is activated, incoming MIDI preset changes are ignored. This is a quick and easy way to temporarily turn MIDI Program Change OFF.*

▼ *Compare Mode must be turned On in the Master Menu for the Compare feature to work.*

PRESET MENU FUNCTIONS

- **Preset Name**

Preset Name allows you to name each of the user presets with a name of up to 12 characters. Position the cursor under the character location and use the data entry control to change the character. The keyboard can also be used to select characters. The chart below shows the keyboard character assignment.

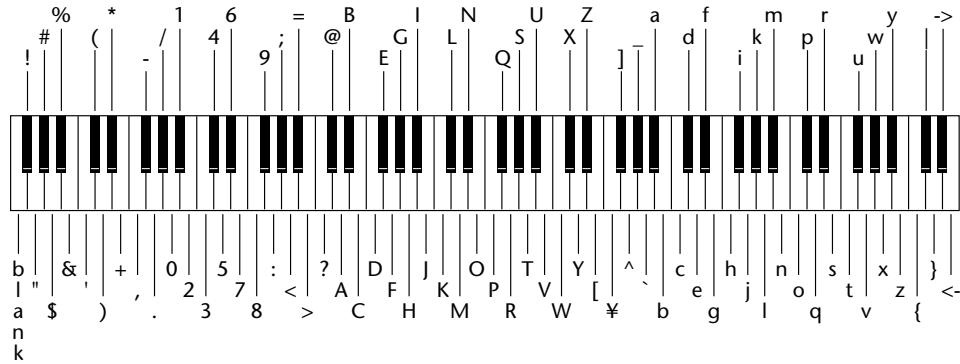
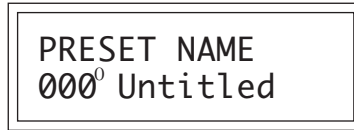

- **Primary Instrument**

This function allows you to select which of the available instrument sounds (or none) will be placed on the primary layer of the current user preset.



- **Secondary Instrument**

This function allows you to select which of the available instrument sounds (or none) will be placed on the secondary layer of the current user preset.



••• *Changing the instrument is a simple way to create a new sound while retaining all other parameters of the preset.*

- **Volume**

Volume sets the amplitude of the primary and secondary instruments. This function also allows you to compensate for the relative volume differences between instruments.

```
VOLUME
pri:127  sec:64
```

- **Pan**

Pan allows you to independently set the initial pan position of the primary and secondary instruments. A value of -7 pans the instrument hard left and a value of +7 pans the instrument hard right. This pan setting is only valid if "P", for preset pan, is selected in the main display (or the Midimap).

```
PAN
pri:-7  sec:+7
```

- **Key Range**

Key range sets the keyboard range of both primary and secondary instruments. This sets the keyboard range for the entire preset and will further limit the primary and secondary keyboard ranges. The key range can be set anywhere from C-2 to G8.

```
KEY RANGE
C-2 -> G8
```

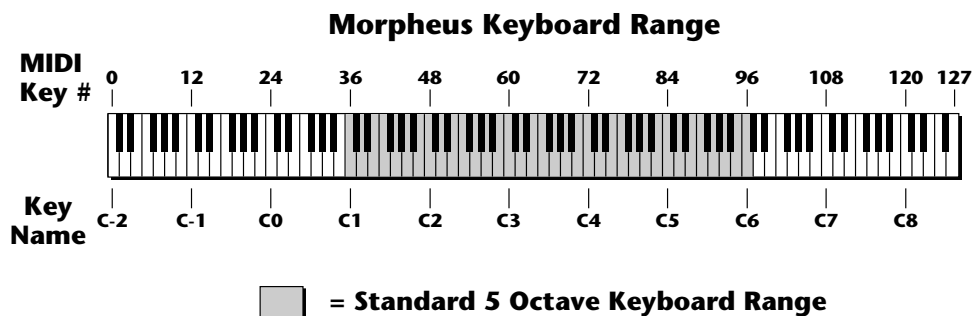

- **Primary Key Range**

Key range sets the keyboard range of the primary instrument. This is useful for creating positional crossfades and keyboard splits between the primary and secondary layers. The key range can be set anywhere from C-2 to G8.

```
KEY RANGE pri
C-2 -> G8
```

- **Secondary Key Range**

Key range sets the keyboard range of the secondary instrument. The key range can be set anywhere from C-2 to G8.

```
KEY RANGE sec
G#4 -> G8
```

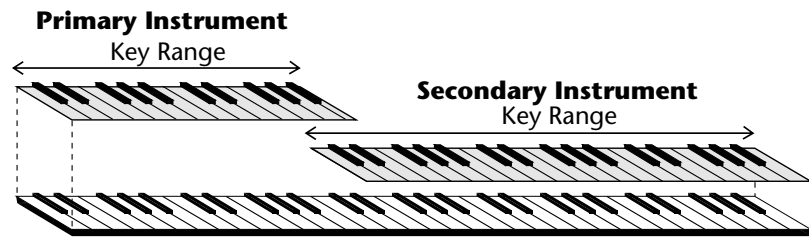

SPLIT KEYBOARD

This diagram shows how a “split” keyboard can be programmed using the primary and secondary instruments.

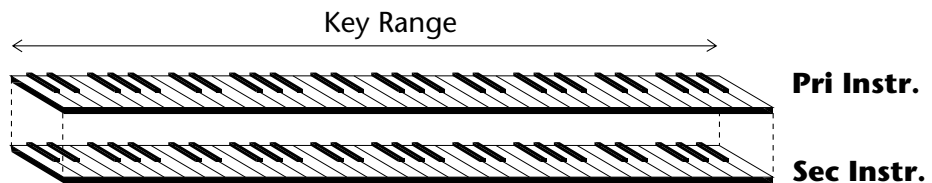

LAYERING TWO INSTRUMENTS

This diagram shows how instruments can be layered or “stacked” using the primary and secondary instruments.

••• Entire presets can also be combined to form split or layered keyboards. See the chapter on Hyperpresets in this manual.

- **Transpose**

This function allows you to transpose the key of the primary and secondary instruments in semitone intervals by shifting the keyboard position relative to middle C. The transpose range is -36 to +36 semitones.

```
TRANPOSE
pri:+00  sec:+00
```

- **Coarse Pitch Tuning**

This function allows you to change the tuning of the primary and secondary instruments in semitone intervals. The coarse tuning range is -36 to +36 semitones.

```
PITCH TUNE crse
pri:+00  sec:+00
```

- **Fine Pitch Tuning**

This function allows you to change the tuning of the primary and secondary instruments in 1/64 semitone intervals (approx. 1.56 cents). The fine tuning range is ± 1 semitone.

```
PITCH TUNE fine
pri:+00  sec:+00
```

- **Alternate Volume Envelope On/Off**

Each instrument has its own factory preset AHDSR volume envelope which is used if this parameter is set to Off. Turn Alternate Volume Envelope On to use the user-programmable alternate envelope.

```
ALT VOL ENVELOPE
pri:Off  sec:0n
```

••• Use Transpose when you want the instrument's timbre to remain constant.

Use Coarse Tuning when you want to change the timbre of the instrument.

••• Use the Coarse Tuning control to change the tuning of multiple drum instruments.

••• See pages 73-74 for an explanation of the envelope parameters.

••• Shortening the attack and release times of the Alternate Envelope can alleviate channel "ripoff" problems. Morpheus examines the Alternate Envelope to determine if a channel can be reused.

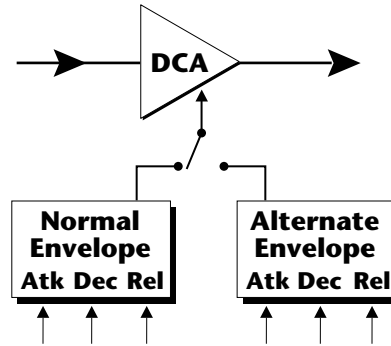

• Primary Alternate Envelope Parameters

This function allows you to adjust the alternate volume envelope parameters for the primary instrument. The parameters are Attack time, Hold time, Decay time, Sustain level, Release time and are adjustable from 00 to 99.

P:	A	H	D	S	R
	00	00	00	99	16

• Secondary Alternate Envelope Parameters

This function allows you to adjust the alternate volume envelope parameters for the secondary instrument. The parameters are Attack time, Hold time, Decay time, Sustain level, Release time and are adjustable from 00 to 99.

S:	A	H	D	S	R
	00	00	00	99	16

• Double + Detune

Double + Detune "thickens" the sound by doubling the sound and then detuning it. The amount is variable over a range of 1 to 15. When Double + Detune is on, a particular instrument will use twice as many channels. If Double + Detune is used for both the primary and secondary instruments, the preset will use four channels per key.

DOUBLE + DETUNE	
pri:Off	sec:07

- **Sound Delay**

Sound Delay varies the time between the arrival of a MIDI Note-On message and the onset of a note. The delay time is adjustable from 0 to 14 seconds (000-127).

```
SOUND DELAY
pri:000  sec:000
```

- **Sound Start**

This function allows you to set where a sample begins playing when you hit a key. A setting of 000 plays a sound from the beginning, higher values move the sample start point toward the end of the sound.

```
SOUND START
pri:000  sec:000
```

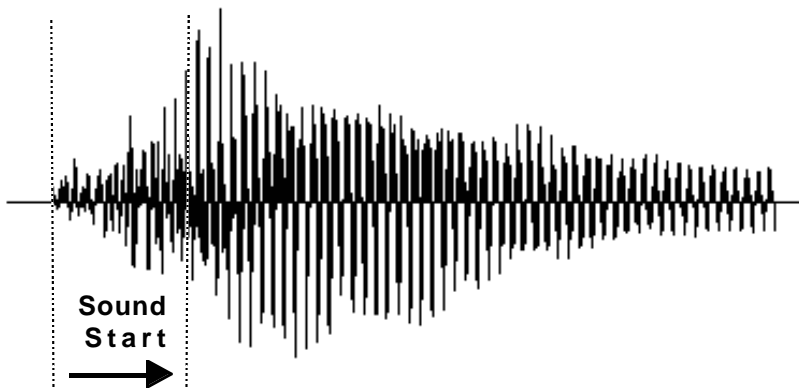

The Sound Start parameter allows you to cut off the beginning of the sound. Higher values move the start point toward the end of the sound.

- **Sound Reverse**

When sound reverse is turned On, the instrument will be played backwards. Since instruments tend to sound very different when reversed, this function extends the number of possible sounds in Morpheus.

```
SOUND REVERSE
pri:0ff  sec:0n
```

••• See the Step-By-Step section of this manual for an application using Sound Start.

••• The Sound Start parameter can be useful to remove the gradual attack of a reversed sound. The Loop Offset parameters can also be put to good use with reversed sounds.

• **Nontranspose**

This function turns keyboard transposition On or Off for the primary and secondary instruments. With Nontranspose On, the keyboard will not control the pitch of the instrument. This is a useful function for drones or “chiffs”, which you may not want to track the keyboard.

```
NONTRANSPOSE
pri:0ff  sec:0n
```

• **Loop Enable**

This function allows you to turn the loop in a sound On or Off. Looping is a way that sounds can be sustained indefinitely. If you want an instrument to play once, then stop, turn Off the Loop Enable function.

```
LOOP ENABLE
pri:0ff  sec:0n
```

• **Loop Offset**

All the Morpheus instruments have been factory looped for your convenience. The Loop Offset function allows you to modify the Loop Start Point and the Loop Size so you can create your own loops.

By looping the sound on the attack portion of an instrument, you can create new waveforms. The Loop Start and Loop Size parameters can cross sample boundaries so that more than one instrument will play. Sample boundary crossing may be useful to create a special effect or background ambience. A Start and Size Offset of 000,000 returns you to the factory loop setting.

LOOP OFFSET IDEAS

••• Loop offset can be used to create interesting new timbres by looping on the attack transient of an instrument.

••• By traversing several instruments you may find interesting polyrhythms.

••• Extremely LONG loop sizes can create incredible background ambience. Use pitch-shifting and multiple keys.

Primary

```
LOOP OFFSET
StartP +000,000
```

```
LOOP OFFSET
SizeP +000,000
```

Secondary

```
LOOP OFFSET
StartS +000,000
```

```
LOOP OFFSET
SizeS +000,000
```

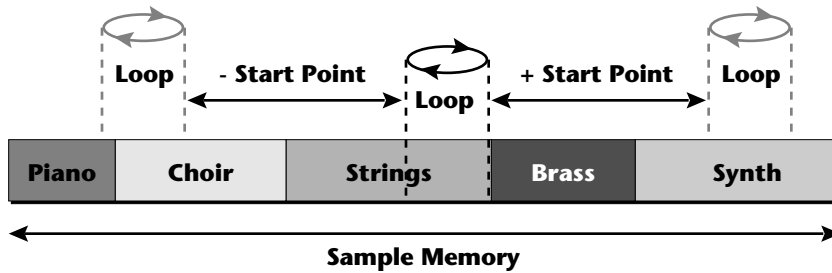

Changing the Loop Offset Start point moves the loop forward or backward (+ or-) through the sample memory, keeping the loops size constant. Large changes will move the loop completely out of the original sample.

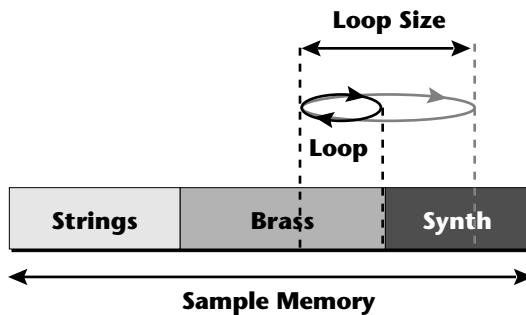

Changing the Loop Offset Size alters the size of the loop, leaving the loop start point stationary. Large positive offsets will enlarge the loop to encompass multiple samples.

• **Solo Mode**

Solo mode provides the playing action of a monophonic instrument. It can make wind and string instruments sound more realistic by preventing more than one note from sounding at once. Two types of solo mode are provided: *Wind Controller* mode and *Synth* mode. In either solo mode, if a new note is played while another is being held, the envelope generators do not retrigger and the sample remains in the loop. This allows a legato playing technique to be used.

Wind Mode

The envelope generator attack always begins at the start of the attack phase when playing staccato. When playing legato, the envelope generator stays in the sustain phase.

Synth Mode

The envelope generator attack begins at whatever point in the release phase is in when a new key is pressed. When playing legato, the envelope generator stays in the sustain phase.

```
SOLO MODE
p:Off    s:Wind
```

••• Sounds are looped so that they will continue to sound as long as the key is held.

••• When using a negative loop start point, the sound may jump back to a point **before** the start of the sample during the loop cycle.

••• Solo Mode allows you to simulate certain playing techniques such as "Tongueing" on a saxophone, where the attack is only heard on certain notes.

▼ There is a four note limit for remembering notes in the First and Last Note Priority modes.

• Solo Mode Priority

When multiple notes are played and held in solo mode, the last note played is always heard. As notes are released, the solo mode priority determines which note will take over from the last note played.

- **High Note Priority** - If multiple notes are being held in solo mode, the highest key being held will play when the last-played key is released.
- **Low Note Priority** - If multiple notes are being held in solo mode, the lowest key being held will play when the last-played key is released.
- **First Note Priority** - If multiple notes are being held in solo mode, and the last note is released, the note will jump back to the first note.
- **Last Note Priority** - If multiple notes are being held in solo mode, only the note last pressed will play. If the note is released it jumps back to the last note before that.
- **Drum** - If multiple notes are being held in solo mode, only the note last pressed will play. If the note is released, no jumping occurs.

```
SOLO PRIORITY
p:Low    s:Hi
```

• Portamento Rate

Portamento is a smooth gliding between notes instead of the normal instantaneous change in pitch when a new key is pressed. The portamento rate is the time it takes to glide to the new pitch. The larger the value, the slower the glide rate. The rate is adjustable from 1-127 or it can be turned Off. Portamento glides at a linear rate between notes and can be set separately for the primary and secondary layers. Portamento works both in and out of Solo Mode.

```
PORTAMENTO RATE
pri:127  sec:Off
```

• Portamento Shape

The portamento is variable from convex exponential (8) to linear, for both the primary and secondary instruments. Using the exponential shapes, the portamento rate will slow as the note nears its destination.

```
PORTAMENTO SHAPE
pri:Ex4   sec:Lin
```

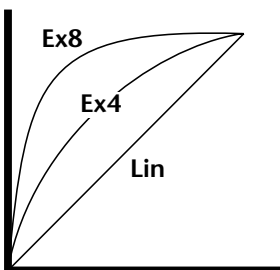

The portamento shape can be varied from linear to convex exponential.

• **Portamento Mode**

This function sets the number of notes that will be affected by portamento. For example, if the Portamento Mode is set to two keys and a three-note chord is played, only two of the notes will glide. Notes will glide from the previous note or notes played. By setting the number of keys to match the number of notes in your chords, smooth glides between those chords can be accomplished without having notes glide in from random starting points. The number of keys can be set from mono to 5 note polyphonic.



• **Crossfade Mode**

This function determines which of the following crossfade modes will be selected: Off, Crossfade, or Cross-Switch.

Off

When “Off” is selected, crossfade is disabled.

Crossfade

When “X-Fade” is selected, a control input is used to fade between the primary and secondary instruments. Any modulation source may be used as an input (velocity, wheel, etc.).

Cross-Switch

When “X-Switch” is selected, the secondary layer is selected if the input crosses a certain threshold or if a footswitch controlling cross-switch is activated. The switch occurs only at the start of the note; no further switching takes place while the key is held down. If key position or velocity is routed to cross-switch, the threshold is the *switch point*. Realtime controllers do not have any effect when routed to cross-switch.

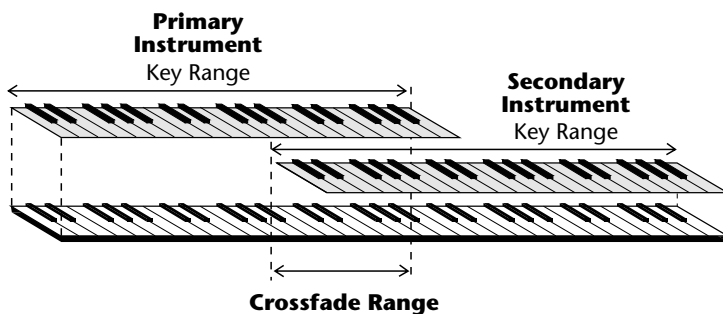
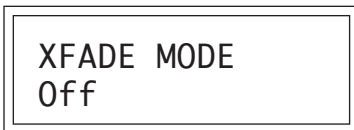

By overlapping the primary and secondary instruments, you can crossfade or cross-switch between the layers.

▼ To enable the crossfade or cross-switch functions, you must assign **Crossfade** to a modulation source in the *Realtime* or *Note-On Modulation* screen.

••• See also, *Cross-Switch Point* on page 113.

••• To use the keyboard for crossfade, set the *Crossfade Balance* to 64 and the *Key Center* to the split point.

• **Crossfade Direction**

This function determines the polarity of the crossfade or cross-switch. The direction is either primary → secondary, or secondary → primary.



• **Crossfade Balance and Amount**

The crossfade balance parameter determines the initial balance between the primary and secondary layers. Higher values shift the balance to the secondary instrument. When the Crossfade Direction is Pri->Sec, Modulation subtracts from the primary volume and adds to the secondary volume. When crossfade modulation and balance equal 64, the two instruments are at equal volume.

The crossfade amount parameter determines the range over which crossfading will occur. Crossfade amount is variable from 000 to 255. The larger the value, the more modulation will be required to effect a complete crossfade.

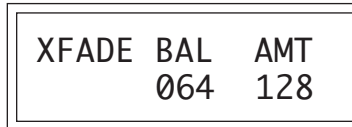

••• A Crossfade Balance setting of 000 would be appropriate with a source such as a modulation wheel or footpedal, either of which can only change the value in a positive direction.

▼ In order to use the Crossfade or Cross-Switch functions, you must assign Crossfade to a modulation source in the Realtime or Note-On modulation screens.

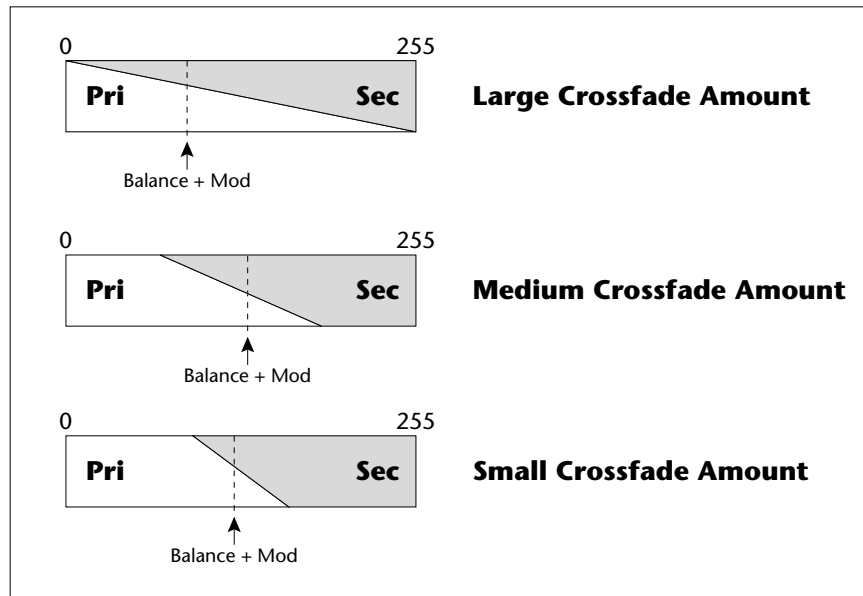

Modulation and Crossfade balance are **added** together to determine the mixture of primary and secondary instruments. Higher values increase the secondary volume.

• **Cross-Switch Point**

The cross-switch point determines the point at which cross-switching will occur when key position or velocity is controlling cross-switch.

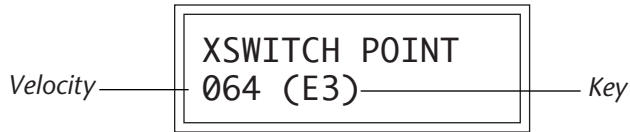

• **Primary Filter Type**

This screen allows you to select one of 197 Z-Plane filter types available in ROM. These filters include: traditional low-pass filters, flanger simulators, vowel formants, distortion filters, acoustic instrument models and many, many more. See the reference section for a complete listing and descriptions of the filters.

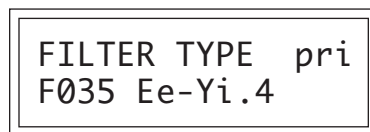

• **Secondary Filter Type**

This screen allows you to set the filter type for the secondary layer. See Primary Filter Type.



• **Filter Level**

This function sets the amount of signal into the filter. This control can be used to balance the levels between instruments or to control the distortion characteristics of the filter. Depending on the type of instrument and the filter, this control can have a dramatic effect on the sound. This control differs from the Volume parameter which adjusts the volume *after* the filter. The default setting is 255 (full level).



▼ To enable the Cross-switch function, you must assign **Crossfade** to a modulation source in the Note-on or Realtime Cords screens.

▼ Under certain unusual circumstances the filters may overload, producing a loud objectionable noise. Turn down the Filter Level value to alleviate the problem.

• **Morph Offset**

This function allows you to set the initial point in the filter morph with no modulation applied. Subsequent modulation will be added or subtracted to this value.

MORPH OFFSET
pri:096 sec:000

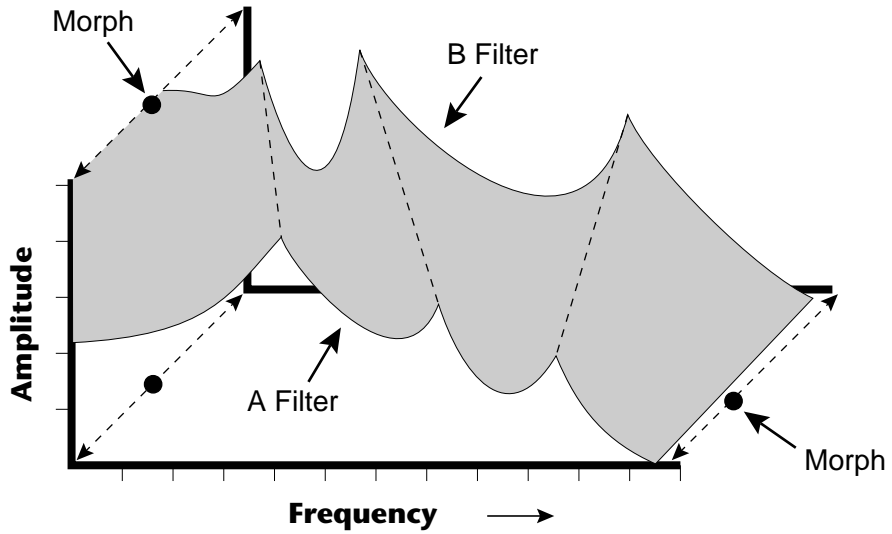

The Morph Offset sets the point along the morph axis where the filter starts with no modulation applied.

• **Filter Frequency Tracking**

If the filter frequency remains constant as the pitch of a sound is varied, the timbre of the sound will change with pitch. A way to correct this is to have the filter's frequency track the pitch of the note. **This function sets the initial frequency of the filter's pitch tracking.** In general, you can think of frequency tracking as a tone control. In order to have keyboard tracking, you must also patch the "Keyboard to Filter Frequency Tracking" in the Note-On modulation screen.

FILT FREQ TRACK
pri:000 sec:000

••• In many of the filters, the Filter Frequency Tracking works like a tone control which brightens or darkens the sound.

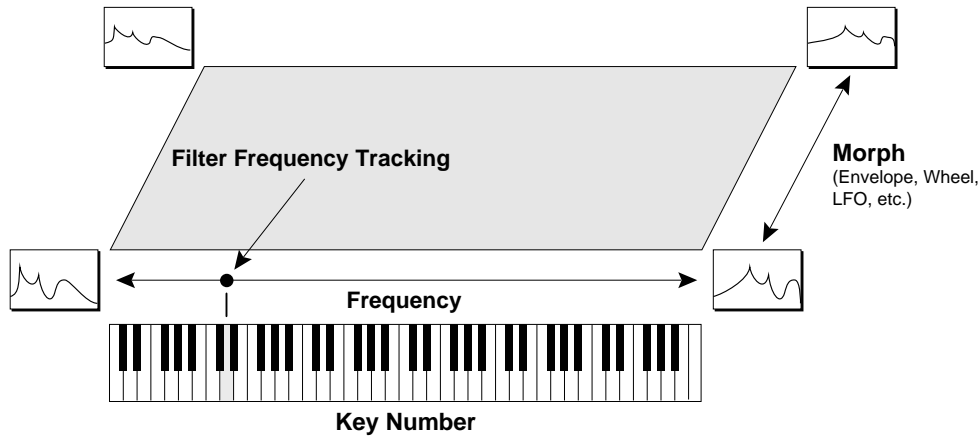

Filter Frequency Tracking allows the timbre of the sound to remain constant up and down the keyboard (if Key Number is routed to this parameter).

• **Filter Transform 2**

Suppose we added yet another dimension to the filter model. We have the realtime *Morph* parameter, the *Frequency Tracking* parameter (set at note-on time) and one more parameter, perhaps controlling the amount of the filter peaks with key velocity. A way to visualize a three-dimensional filter model is shown in the diagram below.

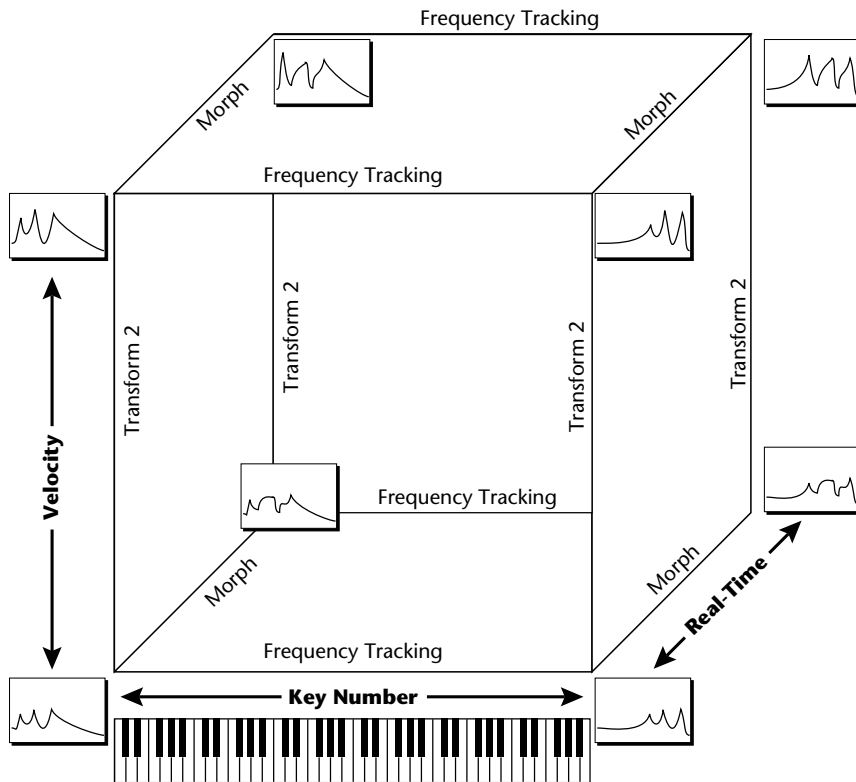

Each Morpheus filter is actually constructed of up to eight different complex filters.

••• The filters labeled with ".4" in their name do not use the Transform 2 parameter.

Each axis of the three-dimensional cube changes the filter in a different way. In the example above, key number is being applied to the Frequency Tracking parameter in order to make the filter frequency track or follow the notes played on the keyboard.

In the 3-D filter model, there is another note-on (*defined at the time the note is pressed*) parameter, Transform 2. Unlike the frequency tracking parameter, the effect of Transform 2 varies from filter to filter. In the example above, Transform 2 is being used to vary the size of the peaks and notches in the filter. The frequency plots in the upper plane of the cube have sharper peaks. In the example above, key velocity is being used to control Transform 2 and the sharpness of the filter peaks.

Filter Transform 2 sets the **Initial Point** along the Transform 2 axis. Subsequent modulation (from note-on modulation) adds to this initial setting for the primary and secondary filters.

```
FILT TRANSFORM 2
pri:000  sec:127
```

• Filter Reverse

This function allows you to reverse the direction of all of the filter controls. Key Tracking, Transform 2 and the Morph parameters will all operate in reverse. The Offset points are reversed, as well as the direction of filter modulation.

```
FILTER REVERSE
pri:0ff  sec:0ff
```

• Auxiliary Envelope

This is a supplementary, utility envelope that can be routed to any realtime control destination including the Morph filter. The auxiliary envelope parameters are: Envelope Amount, Delay, Attack Time, Hold Time, Decay Time, Sustain Level, and Release Time. The delay time is variable from 0 to 13 seconds (000-127). The envelope amount is variable from -128 to +127. Negative values will produce inverted envelopes.

••• For more information on the Envelopes, see the Preset Programming section of this manual.

```
AUX ENV  AMT DLY
          +127 000
```

```
A:  A  H  D  S  R
    00 00 00 99 20
```

• **LFO 1 - Shape & Amount**

This screen controls the waveshape and amount of Low Frequency Oscillator 1. The LFO can be used to produce vibrato (when routed to pitch), or tremolo (when routed to volume). The LFO can be routed to control any of the Realtime Modulation destinations (page 123). The five LFO waveshapes are: Triangle, Sine, Square, Sawtooth, and Random. The amount can be varied from -128 to +127. Negative values will produce inverted waveshapes.



••• For more information on the LFOs, see the Preset Programming section of this manual.

• **LFO 1 - Rate, Delay & Variation**

This screen controls the rate, delay and variation of LFO 1.

LFO Rate

Varies the LFO speed from 0.052 Hz to 25 Hz (000-127).

LFO Delay

Sets the amount of time between hitting a key and the onset of modulation. This can be used to simulate an effect often used by acoustic instrument players, where the vibrato is brought in only after the initial note pitch has been established. The delay range is variable from 0 to 13 seconds (000-127).

LFO Variation

Sets the amount of random variation of an LFO each time a key is pressed. This function is useful for ensemble effects, where each note played has a slightly different modulation rate. The higher the number, the greater the note to note variation in LFO rate. LFO variation is variable from 000-127.

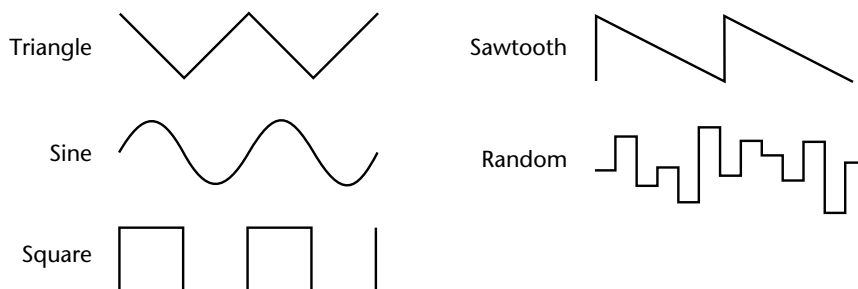
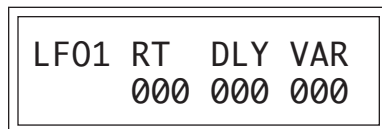

• **LFO 2 - Shape & Amount**

LFO 2 is functionally identical to LFO 1.

• **LFO 2 - Rate, Delay & Variation**

LFO 2 is functionally identical to LFO 1.

• **Function Generators 1 and 2**

The Function Generators are eight segment modulation sources with conditional jumping capabilities and selectable segment shapes. Level and Time parameters are provided for each stage. In addition, the shape of each stage can be individually selected from a palette of 63 shapes. The function generator can be used when you want complex and precise control over a parameter. Through the creative use of its conditional jumps and curves, the function generator can serve as a complex LFO, a complex envelope generator, a mini-sequencer, a random source or all at once if you desire.

••• For more information on Function Generators, see the Preset Programming section of this manual.

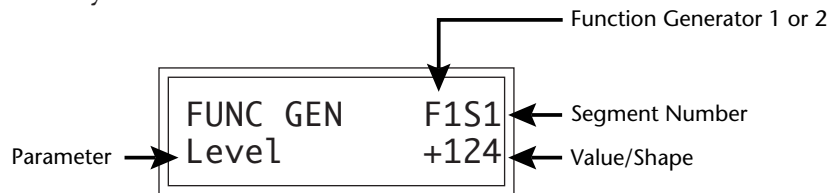

Function Generator Parameters

Level	+127
Time	0750ms
Shape	Linear
CondJump	Never
CondValue	+000
CondDestSeg	2

••• Routing the Function Generator to control Pitch makes it easy to hear what you are doing.

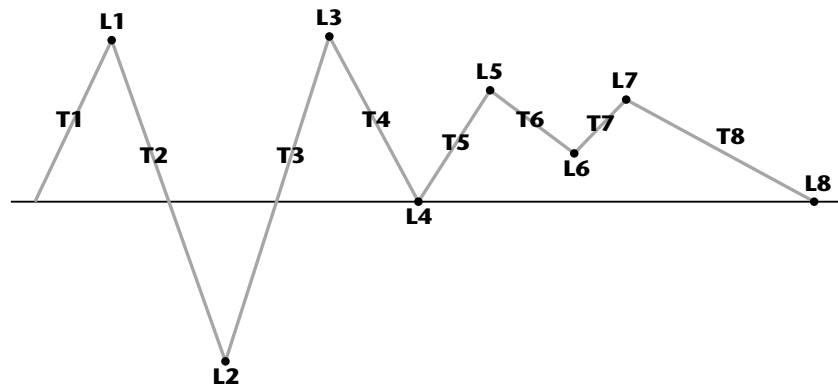

The Function Generator contains eight segments, each with a level and time parameter.

The function generator can have up to eight segments, each with a *Level* and a *Time* parameter. The level parameter can be either positive or negative. Each segment of the function generator can have a different *Shape*. There are 63 different shapes consisting of various curves, straight and crooked line segments, random, chaos and delays.

FUNC GEN	F1S1
Level	+124

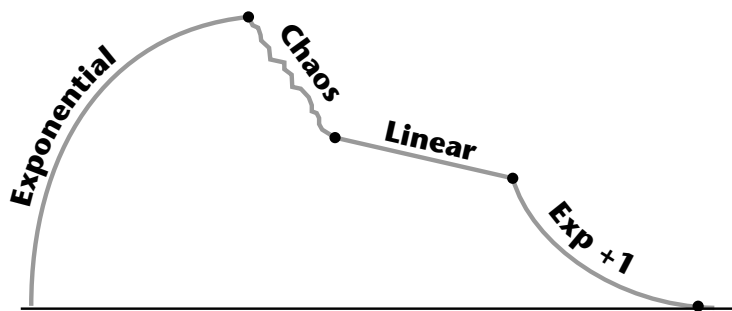

Four of the 63 curves are shown below. By combining the various curve shapes, extremely complex functions can be created. See the Reference Section of this manual for the complete set of function generator curve diagrams.

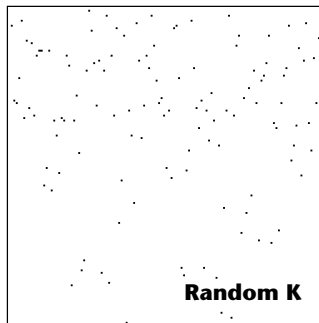
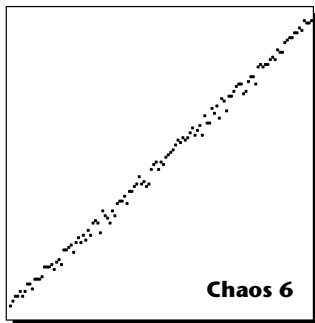
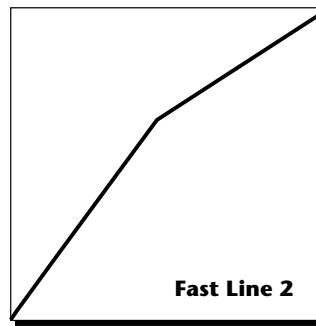
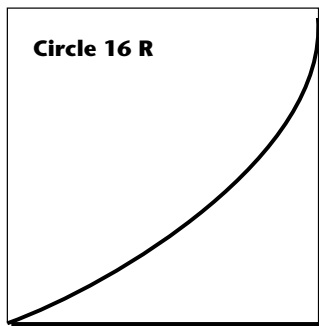

Function Generator Curves

- Linear
- Exponential +1
- Exponential +2
- Exponential +3
- Exponential +4
- Exponential +5
- Exponential +6
- Exponential +7
- Circle 1.4
- Circle 1.6
- Circle 1.8
- Circle 1.16
- Squeeze
- Fast Line 1
- Fast Line 2
- Fast Line 3
- Medium Line 1
- Medium Line 2
- Slow Ramp 1
- Slow Ramp 2
- Bloom
- Bloom 2
- Circle 1.16 Reverse
- Circle 1.8 Reverse
- Circle 1.6 Reverse
- Circle 1.4 Reverse
- Slow Curve 1
- Slow Curve 2
- Delay DC
- DC Delay
- Curve 2x
- Curve 2x B
- Curve 2x C
- Ziz Zag 1
- Ziz Zag 2
- Ziz Zag 3
- Chaos 03, 06, 12, 16, 25, 33, 37, 50, 66, 75, 95, 99
- Linear Shuffle 1
- Linear Shuffle 2
- Random A-L
- Random Z

The function generator can be programmed to jump between segments based on certain conditions. Because the decision to jump is based on conditions, these jumps are called *Conditional Jumps*. For example, the function generator could be programmed to loop only if the key is still being held. In the diagram below, the function generator has been programmed to jump back to segment 3 if the key is held but jump to segment 4 whenever the key is released.

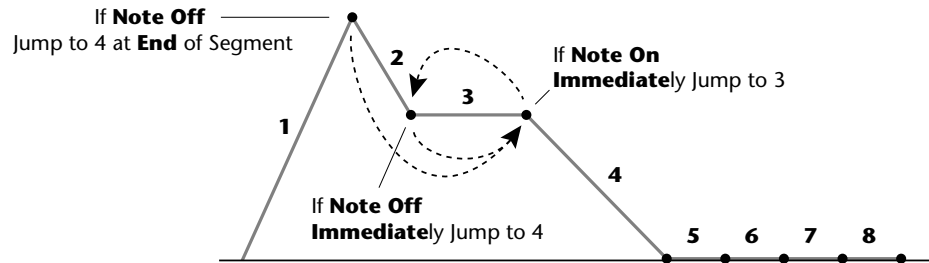

••• A Conditional Jump always goes to the *Beginning* of the destination segment.

Conditional jumps can be programmed to jump to the destination segment immediately or they can wait until the end of the segment before jumping. The conditional jumps are:

- Never** Never jumps. Always goes on to next segment.
- Always End** Always jumps at the end of the current segment.
- Note On End** Jumps at the end of the segment if the note is still on.
- Note On Immed.** Jumps immediately if the note is still on.
- Note Off End** Jumps at the end of the segment if the note is off.
- Note Off Immed.** Jumps immediately if the note is off.
- LFO 1 or 2 End** Jumps at the end of the segment if the value of the selected LFO is equal or greater than the conditional value.
- Footsw. 1-3 End** Jumps at the end of the segment if the selected footswitch is pressed.
- Footsw. 1-3 Immed.** Jumps immediately if the selected footswitch is pressed.
- Velocity End** Jumps at the end of the segment if the velocity value is greater than a positive conditional value or less than a negative conditional value. See the following page.
- Key End** Jumps at the end of the segment if the note value is greater than a positive conditional value or less than a negative conditional value. See the following page.

▼ Remember to turn up the LFO amount when using LFOs as conditionals.

For Velocity End & Key End

FUNC GEN	F1S1
CondValue	+064

When the value is **Positive**, a jump occurs if the velocity or key number is **Greater** than value shown.

FUNC GEN	F1S1
CondValue	-064

When the value is **Negative**, a jump occurs if the velocity or key number is **Less** than value shown (ignoring the sign).

••• When one segment jumps to another at a different level, a smooth transition is made between the two. The time to the end of the destination segment remains as specified.

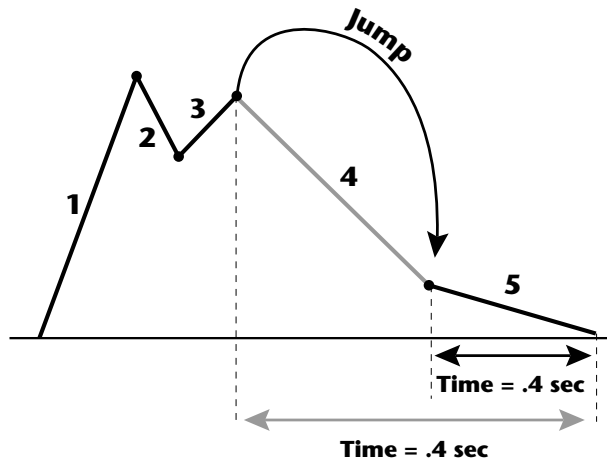

In the example above, segment 4 has been skipped, but the time to the end of segment 5 will remain the same (400 milliseconds). This will alter the slope of segment 5.

• **Function Generator Amount**

This control scales the output of the function generator before it is applied to a modulation destination (in the Realtime Control screen). The amount is like a water faucet. It controls “how much” of the function generator is output. If a negative value is selected, the function generator output will be inverted. Function generator 1 or 2 is selected on the top line of the display (F1 or F2).

FUNC GEN AMT	F1
+064	

••• Drawing your function generator ideas on paper first will simplify the programming process.

••• Remember that you must assign the function generator to a destination in the Realtime Control screen.

••• The Function Generator Amount can also be modulated by a Realtime Control source.

PRESET MENU

Note-On

Modulation Sources

Key Number, Key Velocity
 Initial Pitch Wheel Amount
 Initial Controller A Amount
 Initial Controller B Amount
 Initial Controller C Amount
 Initial Controller D Amount
 Initial Mono Pressure Amount
 Initial FR Function Gen.
 Amount

Destinations

Off
 Pitch, Primary Pitch
 Secondary Pitch
 Volume, Primary Volume
 Secondary Volume
 Attack, Primary Attack
 Secondary Attack
 Decay, Primary Decay
 Secondary Decay
 Release, Primary Release
 Secondary Release
 Crossfade
 LFO 1 Amount, LFO 1 Rate
 LFO 2 Amount, LFO 2 Rate
 Auxiliary Envelope Amount
 Auxiliary Envelope Attack
 Auxiliary Envelope Decay
 Auxiliary Envelope Release
 Function Gen 1 Amount
 Function Gen 2 Amount
 Portamento Rate
 Primary Portamento Rate
 Secondary Portamento Rate
 Filter Morph
 Primary Filter Morph
 Secondary Filter Morph
 Pan, Primary Pan
 Secondary Pan
 Sample Start
 Primary Sample Start
 Secondary Sample Start
 Tone, Primary Tone
 Secondary Tone
 Filter Level, Primary Filter Level
 Secondary Filter Level,
 Filter Freq. Tracking,
 Primary Filter Freq. Tracking
 Secondary Filter Freq. Tracking
 Filter Transform 2
 Primary Filter Transform 2
 Secondary Filter Transform 2

Note-On Modulation Control

These functions allow you to route Note-On information (information received at note-on time such as velocity or key number) to any of the modulation destinations. Up to 10 simultaneous paths or “patches” may be programmed. For each modulation patch, there is a source, a destination and a corresponding amount parameter which is variable from -128 to +127. Place the cursor under the appropriate parameter and change the patch number, modulation source, modulation destination, or the amount, using the data entry control. If a parameter is not labeled either primary or secondary, it affects both.

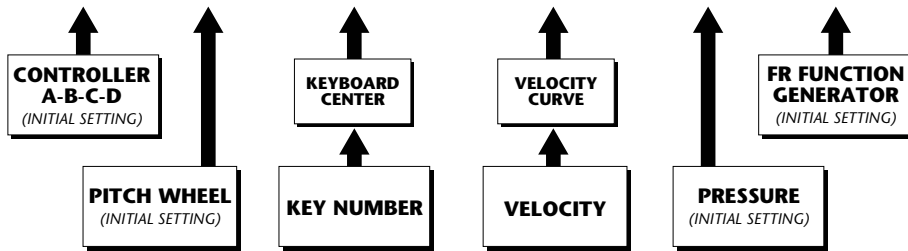
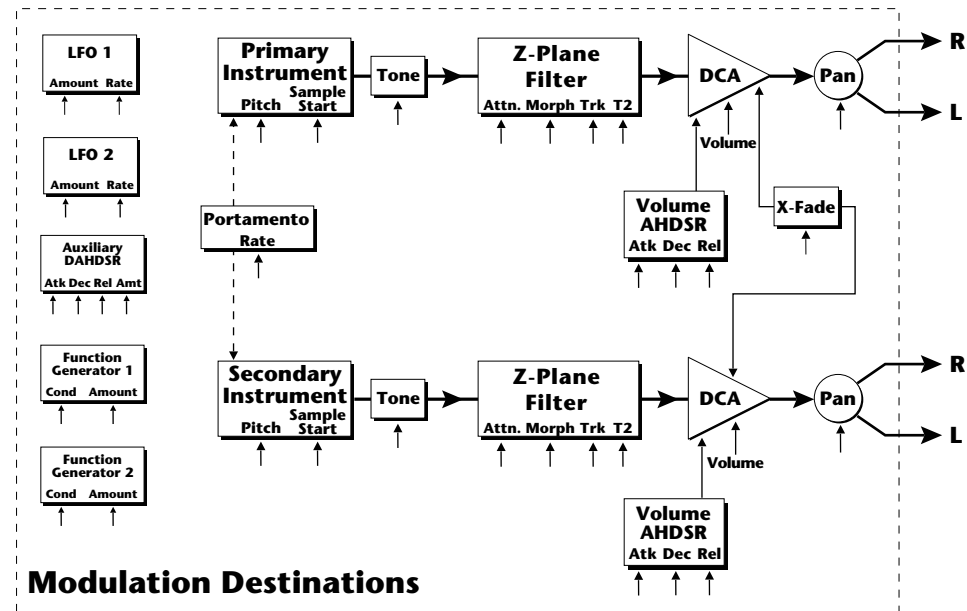

Note-On Modulation Sources

• **Realtime Modulation Control**

These functions allow you to route realtime controllers to any of the modulation destinations except Tone, Sample Start, Filter Frequency Tracking and Filter Transform 2. Up to 10 simultaneous patches may be programmed. For each modulation patch, there is a source and a destination parameter. Place the cursor under the appropriate parameter and change the patch number, modulation source, modulation destination, or the amount using the data entry control. If a parameter is not labeled either primary or secondary, it affects both.

REALTIME CTL #0
PWhl ÷ Off +127

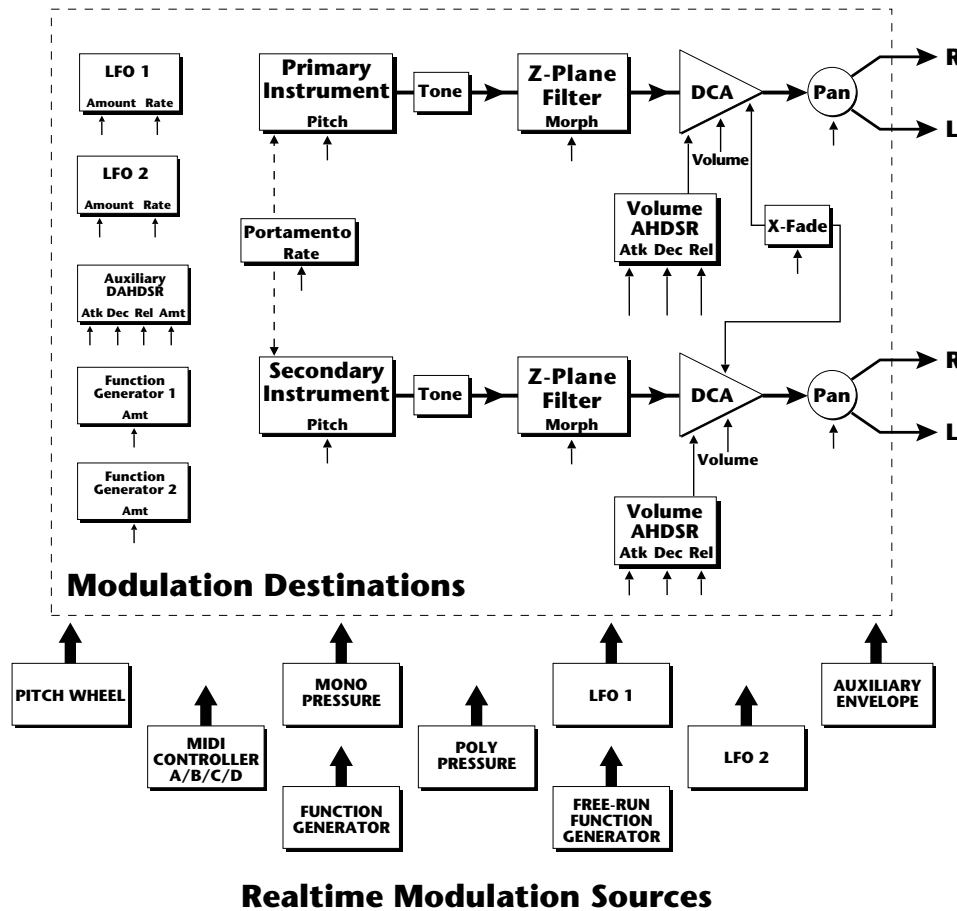

Realtime Modulation Sources

- Pitch Wheel
- MIDI Control A
- MIDI Control B
- MIDI Control C
- MIDI Control D
- Mono Pressure
- Polyphonic Pressure
- LFO 1, LFO 2
- Auxiliary Envelope
- Function Generator 1
- Function Generator 2
- Free-Run Function Generator

Destinations

- Off
- Pitch, Primary Pitch
- Secondary Pitch
- Volume, Primary Volume
- Secondary Volume
- Attack, Primary Attack
- Secondary Attack
- Decay, Primary Decay
- Secondary Decay
- Release, Primary Release
- Secondary Release
- Crossfade
- LFO 1 Amount, LFO 1 Rate
- LFO 2 Amount, LFO 2 Rate
- Auxiliary Envelope Amount
- Auxiliary Envelope Attack
- Auxiliary Envelope Decay
- Auxiliary Envelope Release
- Function Gen 1 Amount
- Function Gen 2 Amount
- Portamento Rate
- Primary Portamento Rate
- Secondary Portamento Rate
- Filter Morph
- Primary Filter Morph,
- Secondary Filter Morph
- Pan, Primary Pan
- Secondary Pan

When Modulating Envelope Attack, Decay or Release Times:

Positive amounts of modulation **increase** the time.
Negative amounts of modulation **decrease** the time.

• **Footswitch Control**

This function allows you to route the 3 footswitch controllers (1, 2 or 3) to any of the footswitch destinations. The footswitches can be routed to switch: Sustain (pri/sec/both), alternate volume envelope (pri/sec/both), alternate volume release (pri/sec/both), cross-switch between the primary and secondary instruments or switch portamento Off or On (pri/sec/both).

FOOTSWITCH CTRL
1 -> Sustain

• **Pitch Bend Range**

This function allows you to specify the pitch wheel range for the current preset if pitch bend is not being globally controlled in the Master menu. Pitch bend range is only used when the pitch wheel is used to control pitch.

PITCH BEND RANGE
+- 12 semitones

• **Pressure Amount**

This function allows you to specify an overall amount parameter for mono or poly keyboard pressure data (pre-patch cord). The pressure amount is variable from -128 to +127.

PRESSURE AMOUNT
+127

• **MIDI Controller Amount**

This function allows you to specify an overall amount parameter (pre-patch cord) which variable from -128 to +127 for each of the MIDI controllers.

CONTROLLER AMT
A:+127 B:+127

CONTROLLER AMT
C:+127 D:+127

▼ *Pressure Amount and Controller A-B-C-D Amount are **MASTER Controls** which affect the amount of modulation which can be programmed in the Realtime Modulation section.*

In order for the Realtime Modulation Control amounts for these functions to have a full range of control, the Pressure and Controller A-D amounts must be set to +127.

• **Velocity Curve**

Incoming velocity data can be modified by a velocity curve in order to provide different types of dynamics in response to your playing or better adapt to the MIDI controller. This function allows you to select one of the four velocity curves or leave the velocity data unaltered (Off). In addition, the velocity curve can be set to “Global”, which means that the global velocity curve (programmed in the Master menu) is used.

VELOCITY CURVE
Global

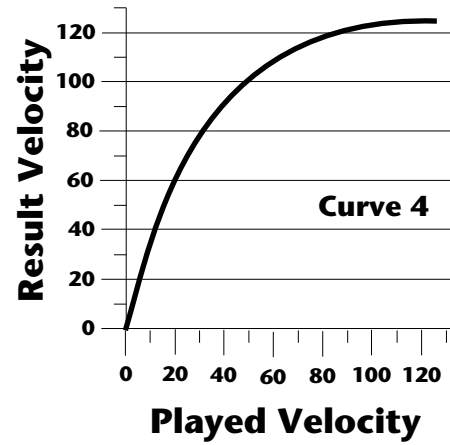
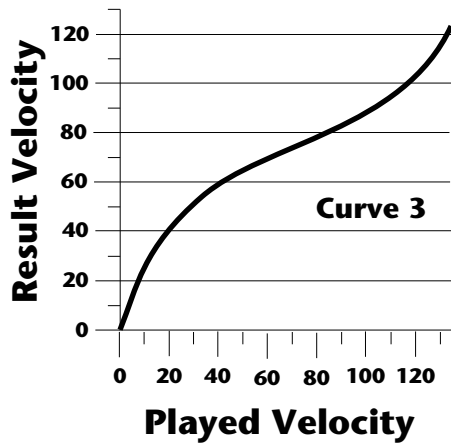
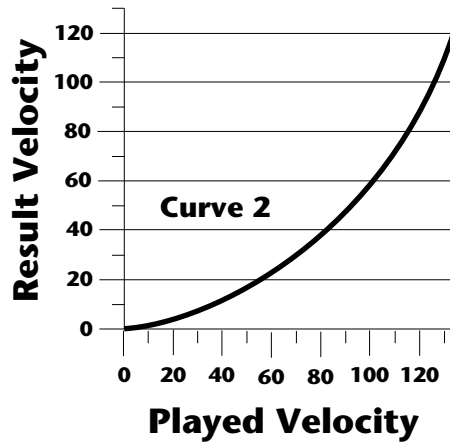
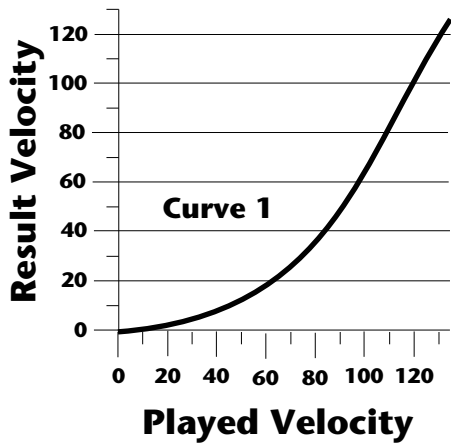

• **Keyboard Center**

The Keyboard Center parameter establishes a reference point for keyboard modulation. Keys above this point will have a positive value and keys below it will be negative. The keyboard center can be set to any key within the range C-2 to G8.

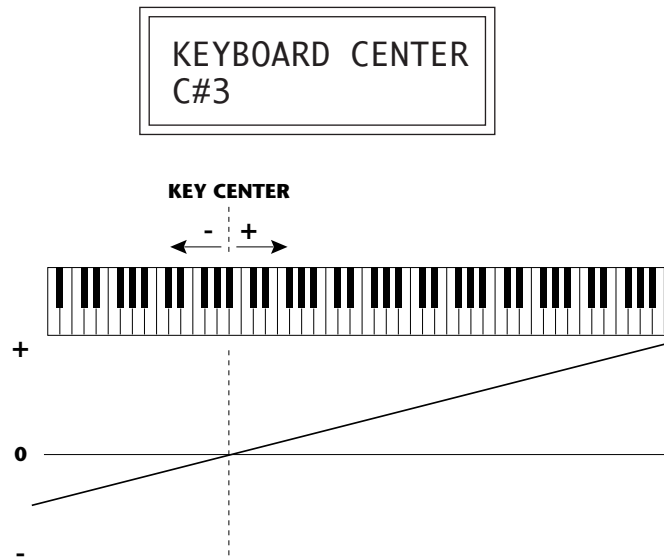

• **Keyboard Tuning**

In addition to the standard equally divided octave tuning, Morpheus contains four other types of scale tuning and one user-definable tuning. This function selects which tuning will be used in the current preset.

The choices of keyboard tunings are:

Equal tuning (12 tone equal temperament)

Standard Western tuning.

Just C tuning (just intonation)

Based on small interval ratios. Sweet and pure, non-beating intervals.

Vallotti tuning (Vallotti & Young non-equal temperament)

Similar to 12 tone equal temperament. For a given scale, each key has a different character.

19 Tone tuning (19 tone equal temperament)

19 notes per octave. Difficult to play, but works well with a sequencer.

Gamelan (Javanese) tuning (5 tone Slendro and 7 tone Pelog)

Pelog-white keys, Slendro-black keys. Exotic tunings of Gamelan flavor.

User tuning

Defined in the Master menu.

- **Mix Select**

This function allows you to direct a particular preset to one of the four destinations (Main, Sub 1, FXA, FXB). This routing is utilized if Mix Select for a particular MIDI channel is set to "Preset" in the current Midimap. Otherwise this setting is ignored. This function allows you to choose the effect bus in the preset rather than by MIDI channel.



MIX OUTPUT
Main

- **Save Preset**

Changes made to a preset in the Preset Edit menu are not made permanent until the preset is *Saved*. To save a preset, move the cursor to the bottom line and select the location for the new preset with the data entry control. The Enter LED will then flash. Pressing the Enter button will confirm the operation.

Any user preset (000-127, bank 0) or RAM card location (000-127, bank 3) may be selected using the data entry control. Writing to a user preset erases the existing preset in that location. Make sure that the destination preset does not contain information that you want to keep.



SAVE PRESET to
064° Preset Name

▼ *In order for the Preset Mix Select to be utilized, the Midimap Mix select must be set to "Preset".*

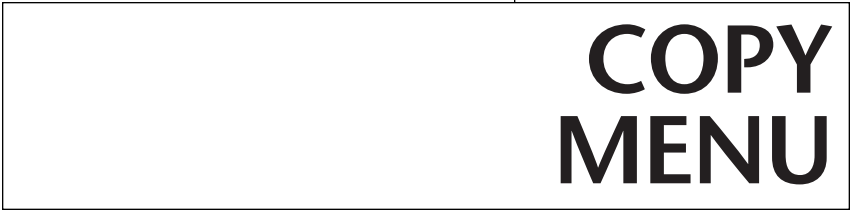



The Copy menu functions allow you to copy data between Presets, Hyperpresets or Midimaps. Selected groups of parameters, such as Function Generator or Effects settings, can be simply copied, making it easy to build new Presets, Hyperpresets or Midimaps.

- When using the Copy functions, you always copy **INTO the Current “Scratch” Preset, Hyperpreset or Midimap**. The copy menus allow you to copy data from anywhere in the machine.

To enable the Copy menu

Press the Copy key, lighting the LED. The current screen will be the one most recently selected since powering up the machine. The cursor will appear underneath the first character of the screen heading on line one.

To select a new screen

Press the Home/Enter key or press the cursor keys repeatedly until the cursor is underneath the screen title heading. Rotate the data entry control to select another screen.

To modify a parameter

Press the cursor key repeatedly (or hold the right cursor key while turning the data entry control) until the cursor is underneath the parameter value. Rotate the data entry control to change the value.

To return to the module

Press the Copy key, turning off the LED. You will be returned to the main screen.

COPY MENU FUNCTIONS

• **Copy Preset**

This function allows you to copy a preset from any location in Morpheus into the current preset location. The current preset is the preset showing in the main screen.

COPY PRESET
000⁰ Preset Name

▼ Remember to SAVE your edited Preset, Hyper preset or Midimap if you want to keep it.

••• Data copied from the same preset will come from the saved version of the preset, NOT the edited version. This could be used as a "Revert" feature if you make a mistake while editing.

• **Copy Layer**

This function allows you to copy everything in the primary or secondary layer (or both) from another preset into the current preset. A primary layer may be copied into the secondary layer and vice-versa. Only parameters which are designated "primary" or "secondary" will be copied. Parameters such as the LFOs or modulation routings will NOT be copied.

There are five options available: Pri to Pri, Pri to Sec, Sec to Sec, Sec to Pri, Pri & Sec (Both)



• **Copy Filter**

This function allows you to copy the filter settings for the primary or secondary layer (or both) from another preset into the current preset.

Copy Filter copies the following parameters only: Filter Type, Filter Level, Morph Offset, Filter Frequency Track (initial setting), Filter Transform 2 (initial setting) and Filter Reverse.

There are five options available: Pri to Pri, Pri to Sec, Sec to Sec, Sec to Pri, Pri & Sec (Both)



• **Copy LFO**

This function allows you to copy the LFO settings for LFO1, LFO2 or both from another preset into the current preset.

There are five options available: 1 to 1, 1 to 2, 2 to 2, 2 to 1, 1 & 2 (Both).



- ***Copy Function Generator***

This function allows you to copy the function generator parameters for either FG1, FG2 or both from another preset into the current preset.

There are five options available: 1 to 1, 1 to 2, 2 to 2, 2 to 1, 1 & 2 (Both).

```
COPY FUNCGEN 1→1
000° Preset Name
```

- ***Copy Auxiliary Envelope***

This function allows you to copy just the auxiliary envelope parameters from another preset into the current preset. There is only a single option.

```
COPY AUX ENV
000° PresetName
```

- ***Copy Note-On Control***

This function allows you to copy the Note-On modulation routings from another preset into the current preset. There is only a single option.

```
COPY NOTE-ON CTL
000° Preset Name
```

- ***Copy Realtime Control***

This function allows you to copy the Realtime modulation routings from another preset into the current preset. There is only a single option.

```
COPY RLTIME CTL
000° Preset Name
```

•••The current hyperpreset is the last one selected or modified.

- **Copy Hyperpreset**

This function allows you to copy a hyperpreset from any hyperpreset into the current hyperpreset location.

```
COPY HYPERPRESET  
0002 HyperName
```

- **Copy Zone**

This function allows you to copy a single hyperpreset zone from any hyperpreset into the current hyperpreset location. Zones may be placed into any other zone number in the current hyperpreset.

```
COPY ZONE 01+ 03  
0002 HyperName
```

- **Copy Free-Run Function Generator**

This function allows you to copy all the Free-Run Function Generator parameters from any hyperpreset into the current hyperpreset location.

```
COPY FREE-RUN FG  
0002 HyperName
```

- **Copy Midimap**

This function allows you to copy an entire midimap into the current midimap location.

```
COPY MIDIMAP  
M00 MidiName
```

- **Copy Channel**

This function allows you to copy all the information from a single MIDI channel from any midimap into the current midimap location. Channels may be placed into any other channel number in the current midimap. The parameters that will be copied are: Preset/Hyper, Volume, Pan, Mix, MIDI Enables, and Bank Select.

```
COPY CHAN  01⇨ 03
M00 MidiName
```

- **Copy Effects**

This function allows you to copy effects from any midimap into the current midimap location. There are three options available: A to A, B to B, A & B (Both). *(Because of the differences between the A and B effects, it is not possible to copy between A and B.)*

Copying a single A or B effect includes all effects parameters and the A or B amount (but not the A->B amount). When both effects are copied, the A->B amount is included.

```
COPY EFFECT  A⇨A
M00 MidiName
```

- **Copy Program Change Map**

This function allows you to copy a single Program Change Map into any other Program Change Map number. Program Change Maps are located in the Master menu.

```
COPY PRG CHG MAP
#1 ⇨ #3
```

- **Copy Bank**

This function allows you to copy an entire bank of 128 programs or a set of 16 Midimaps between ROM, RAM and Card locations. "All" allows you to copy all RAM presets, Hyperpresets and Midimaps to the card or vice-versa.

WARNING

Be careful when using the Copy Bank function. It is very easy to accidentally overwrite an entire bank of data!

There are ten options available:

Presets - RAM to Card, Card to RAM, ROM to RAM, ROM to Card,

Hypers - RAM to Card, Card to RAM,

MIDImap - RAM to Card, Card to RAM,

All - Card to RAM, RAM to Card

COPY BANK
Presets RAM→Card



STEP-BY-STEP



This chapter walks you through Morpheus in a step-by-step manner. Although it is not possible to cover every detail of programming a synthesizer of this complexity, these first steps will hopefully get you started in the right direction. Before starting this chapter, please read the Programming Basics chapter of this manual. It contains important background information, which will help you get the most of this chapter.

- If you are new to synthesizers and electronic music, you may need more background information than this manual provides. There are many books dedicated to synthesizer basics and MIDI available through your local music dealer. Magazines such as Keyboard and Electronic Musician, which are available at most newsstands, contain current information on the subject, as well as valuable programming tips.

Morpheus (or any synthesizer for that matter) is not really one instrument but a collection of modules which can be connected together to create many different instruments. In programming a synthesizer, you become an instrument builder. The more knowledge you have about music, acoustics, and electronics, the more success you will have in constructing the sounds of your dreams.

Learning about sound synthesis will be much easier if you learn to really LISTEN to the sounds all around you, then try to recreate them. Listen to how the pitch rises on that bird's chirp, or how the volume changes on that organ. Soon you'll be hearing sounds in a whole new way. Of course, imitating natural sounds is only a part of sound synthesis. The real fun happens when you create a wonderful new sound that no one has ever heard before. Experimentation + Knowledge = MAGIC!

Programming Morpheus is like exploring new territory. No one before you has EVER had access to this powerful technology. You have to explore to find what's out there!

EDITING PRESETS

A good way to get acquainted with Morpheus is by examining and editing existing presets. If you hear an effect or a control you like, take the time to discover how it was achieved.

Start with a preset you like and try changing it around. If you don't like the result, simply change the preset momentarily and you'll be back to the original sound. Changes are not made permanent until you SAVE a preset. Therefore you can experiment all you want without worrying about losing a sound.

STARTING FROM SCRATCH

When starting from scratch, first select the Default Preset (-defPreset-) which is located in the factory location 127 (bank 1). A default is basically a blank preset which is ready to program. After selecting the default preset, press the Preset button.

- **The Instrument**

The instrument is the basis of your sound. The instruments in Morpheus are digital recordings of various sounds from the simple (sine wave) to the complex (Bosendorfer Piano). The second screen in the Preset menu selects the primary instrument.



Move the cursor down to the bottom line and change the primary instrument using the data entry control. You should be hearing the instrument change as you scroll through the instruments. A patch diagram (shown below) is useful to visualize the connection you have just made. Press Enter when you find an instrument you like.

Turn the data knob one click to the right to the secondary instrument

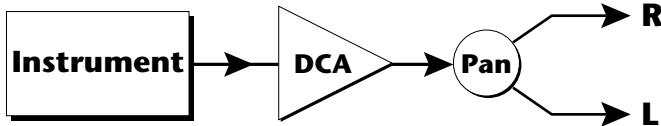

select screen. The secondary instruments are identical to the primary instruments. Change the secondary instrument and listen to the various combinations of the two. What you are doing is actually a simple form of additive synthesis. You are adding two sounds together to form a new sound.

✓ Blending two instruments together can create an ensemble effect if the instruments are different, or a thicker sound if both instruments are the same. Two instruments can “fuse” into one new sound if their harmonic content is similar or if harmonic changes such as vibrato (pitch variation) occur in both instruments simultaneously.

For the next experiment, set the primary instrument to “010 Acoustic Guitar” and the secondary instrument to “034 Piano Bright”. Press Enter.

- **Volume**

Turn the data knob one click to the right to the Volume screen. This screen adjusts the volumes of the two instruments. Refer to the block diagram on the previous page as you adjust the volume of the DCA.

```
VOLUME
pri:110  sec:100
```

As you adjust the volume of the two instruments relative to each other, notice how the quality of the sound changes. Whichever instrument is loudest is perceived as the sound of both. But there is a range where the two instruments seem to “fuse” into one unique entity, somewhat like a harpsichord. Careful mixing can result in many beautiful timbres.

- **Pan**

The next screen, Pan adjusts the balance between the left and right outputs. Panning one instrument hard right (+7) and the other hard left (-7) is a good way to keep the identities of the instruments separate. Try it and notice how the guitar and piano instruments are distinct and separate. When you are finished, return the pan settings to “0” and press Enter.

```
PAN
pri:+0  sec:+0
```

- **Transpose**

Move the data knob ahead four clicks until you find the transpose screen. This function transposes the key of the primary or secondary instrument. Each number represents a semitone interval up or down (+ or -). To transpose an instrument up an octave, move the cursor to the bottom line and set the number to +12. A setting of +7 would result in a perfect fifth. Try transposing the piano and guitar sounds. When you are finished, return the settings to “0” and press Enter.

```
TRANSPOSE
pri:+12  sec:+00
```

✓ Transposing an instrument out of its normal range will completely change the character of the sound. Sine waves transposed down can add a killer bottom end to an otherwise harmless bass sound.

••• Use the coarse tuning control to change the tuning of multiple drum instruments.

••• To hear how *Transpose* and *Coarse Tuning* differ, try them on the multi-percussion instruments.

••• Use *Coarse Tuning* to tune multi-instrument percussion instruments.

• *Coarse Tuning*

This function is related to transpose and in fact, the two work well together in the creation of new timbres. A little background: Transpose works by shifting the keyboard assignment of the samples (as if you were sliding the keyboard up and down). Coarse Tuning keeps the keyboard sample placement constant and actually tunes the samples up. With multisampled instruments such as a piano, the timbre can change dramatically using coarse tuning. (A *multisampled sound* is one that contains multiple samples placed at various points on the keyboard.)

To hear this effect, first **Coarse Tune** the guitar up one octave (+12), then **Transpose** it *down* one octave (-12). The pitch remains the same, but what a difference in the tone! (You may want to turn the Piano instrument Off to make it easier to hear the guitar.)

```
PITCH TUNE crse
pri:+12  sec:+00
```

• *Fine Tuning*

The Fine Tune control is related to the coarse tuning, but has a range of one semitone. When both primary and secondary instruments are the same, detuning one of the instruments slightly will create a “fat” sound useful for strings or ensemble effects.

```
PITCH TUNE fine
pri:+00  sec:+00
```

In preparation for the next experiment, let's clean the slate. Since we haven't SAVED the preset yet, any changes you made will be lost as soon as you change the preset. Do that now. Simply press the Preset Edit button extinguishing the LED, dial momentarily to another preset and then go back to the '-defPreset-'. Now everything is erased. Set the primary instrument to I005 Spectrum Pad, press Home/Enter, then slowly turn the data entry knob until you find the screen shown below.

```
ALT VOL ENVELOPE
pri:0ff  sec:0ff
```

• Alternate Volume Envelope

Turn the Alternate Volume Envelope On for the primary instrument. This enables the next screen, the primary volume envelope.

P:	A	H	D	S	R
	00	00	50	99	15

Going back to the block diagram model, the preset now looks like this:

Every sound you hear, be it a piano note, a drum, a bell or whatever, has

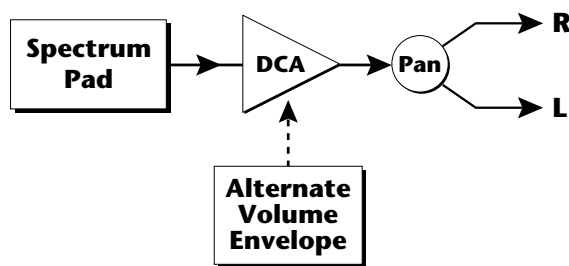

a characteristic volume curve or *Envelope* which grows louder and softer in various ways during the course of the sound. The volume envelope of a sound is one of the clues that our brain uses to determine what type of sound is being produced.

Every instrument in Morpheus has its own volume envelope which is used when the Alternate Envelope parameter is turned Off. By turning the Alternate Volume Envelope On, we can re-shape the instrument's natural volume envelope any way we want. By re-shaping the volume envelope, you can dramatically change the way the sound is perceived. For example, by adjusting the envelope parameters you can make “bowed” pianos or backwards gongs. The diagrams at right show the volume envelopes of a few common sounds.

Set all the numbers to 00 and listen to the sound. You should only hear a little blip. Now move the cursor under the Attack Time (A) and slowly increase the value while playing the keyboard. The attack controls the amount of time it takes for the sound to reach full volume when a key is pressed and held.

Set the attack to “00” and slowly increase the Decay (D) instead. Notice how percussion-like the sound becomes. You have just created the percussion envelope shown at the right.

Set the Sustain (S) to 99 and slowly increase the Release time. Note the effect as you release the note. The release time R controls the time it takes for the sound to die away when a note is released.

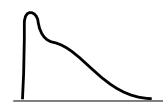

Piano

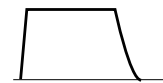

Organ



Strings

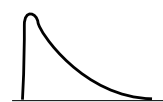

Percussion

••• The generalized envelope shapes of a few types of sounds are shown above.

Practice making different volume envelopes. As you hear everyday sounds, try to imagine what the volume envelope of these sounds might look like.

• **Anatomy of an Envelope**

When a key is pressed, the envelope generator level starts to increase at the **Attack** rate. When it reaches full level, it **Hold**s at that level for the specified **Hold** time. After the hold time has elapsed, the envelope begins to **Decay** back down at the **Decay** rate until it reaches the **Sustain** Level. (Note that all the other parameters are *Rates*, but the Sustain is a *Level*.) The envelope will stay at the Sustain level for as long as the key is held. When the key is Released, the envelope falls back down to zero at the **Release** rate.

The secondary alternate volume envelope parameters perform the same functions on the secondary layer.

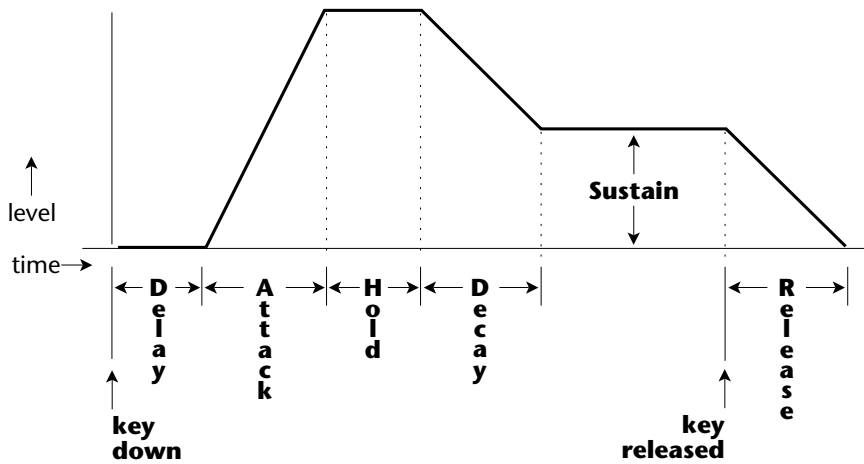

••• For more information about Envelopes, see the Programming Basics chapter in this manual.

••• The Delay parameter is only available in the Auxiliary Envelope.

• **Double + Detune**

The next screen, Double + Detune, doubles the instrument and detunes it slightly by an adjustable amount. This acts like a chorus effect and serves to “fatten” the sound. Try it and notice how much fuller the sound becomes. Because this function works by using two instruments per layer, it halves the number of available notes that can be played. Therefore you should only use this feature when necessary to achieve the desired effect.

```
DOUBLE + DETUNE
pri:06  sec:0ff
```

- **Sound Delay**

This function delays the onset of the note after a key is pressed and is mainly used when a secondary instrument is also present. Go ahead and select a secondary instrument now, then come back to this screen to experiment with the delay. A very small amount of delay can serve to give each layer its own sonic “identity”.

SOUND DELAY
pri:000 sec:000

- **Applications include:**

Echo Effect - Bring in a slightly softer version of the same instrument or even a different instrument. Who says you have to have normal echoes?

Delayed Chorus - Set primary and secondary to the same instrument. Use Double + Delay, Fine Tuning and Sound Delay on the secondary layer.

Sound Splicing - Splice the attack of one sound with the body of another using Sound Delay and Sound Start (the next subject of our investigations). Read on.

- **Sound Start**

Sound Start removes the beginning (attack) of the sound as the value is increased. It's probably time to clean the slate again. Change the preset momentarily then return to the default preset (-defPreset-). Set the primary instrument to: I033 Bright Electric Piano. Now flip back to the Sound Start screen.

SOUND START
pri:000 sec:000

As you slowly increase the Sound Start, notice how the percussive attack of the piano disappears. The sound becomes muted.

• **Application - Sound Splicing**

Sound Splicing is an operation that uses most of the features we've gone over. As mentioned above, Sound Splicing merges the attack of one sound with the body of another to form a new sound. The process is illustrated below.

The alternate volume envelopes are used to fade one instrument out while another fades in. Morpheus also contains many digitally generated waveforms that may be combined with sampled instruments to change the character of the sound, perhaps to add a digital "edge" or add bass. The Sound Delay, Sound Start, Volume and the Transpose parameters allow you to refine the splice point between the primary and secondary instruments.

As an example, let's splice a Piano and an Acoustic Guitar to create a sort of "Piatar". Start with the default preset again, and change only the parameters listed below. The piano instrument is shaped by the Alternate Volume Envelope so that only the percussive attack is heard (a short delay and decay with the sustain set to zero).

Primary	Secondary
Instrument: 033 BrightElPno	Instrument: 012 AcousticGtr3
Volume: 082	Volume: 127
Transpose: +00	Transpose: +12
Alt Envelope: On	Alt Envelope: On
A H D S R 00 04 12 00 00	A H D S R 04 00 55 00 24
Sound Delay: 000	Sound Delay: 001
Sound Start: 000	Sound Start: 033

The Acoustic Guitar 3 instrument serves as the body of the sound. The Sound Delay parameter is used to delay the onset of the guitar until the piano attack has finished, The guitar attack is removed using the Sound Start parameter. The Attack parameter of the Secondary Alternate Envelope is set to 04 so the guitar will smoothly fade in as the piano fades out. The guitar has also been transposed up an octave so that the pitches of the two instruments match. Finally, the volumes of the two instruments are balanced with the volume control.

Splicing is only of the many things you can do with Morpheus. Think of Morpheus as an audio construction set, which allows you to mold the sound as you would a piece of clay. The instruments are like your raw material and the other parameters are the sculpting tools.

• **Time to Save?**

If you wanted to keep this sound, you would have to *SAVE* it using the Save Preset function (the very last screen in the Preset menu). To save a preset, simply move the cursor to the bottom line of the display, select the preset location where you want to store it, then press Enter. That's it!

Warning: Saving a preset erases whatever preset was already stored in that location.

If you want to re-name your preset, do so using the first screen (Preset Name), then save the preset again to the same location.

• **LFO Modulation**

Let's investigate how modulation routings can affect the sound. For these experiments, you use the default preset. If you just wrote over it, there is another one stored in permanent ROM (127, bank 1). Select any primary instrument, but leave the secondary instrument turned Off.

The LFOs (Low Frequency Oscillators) generate repeating waves which are commonly used to animate the sound or create vibrato (a cyclic pitch change). To create vibrato we can use an LFO to modulate the pitch. As you learned in the Programming Basics section, Modulation requires a modulation *Source* and a *Destination*. The LFO is the source and Pitch is the destination. The block diagram below illustrates this connection.

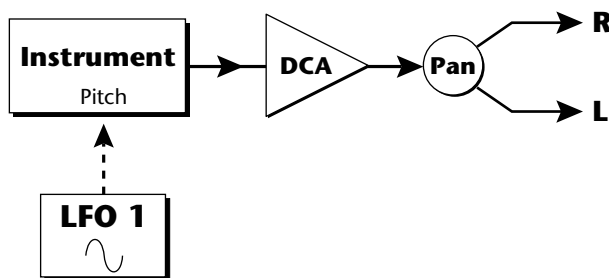

To make the connection between the LFO and the Instrument Pitch, move through the Preset parameters until you find the screen shown below.

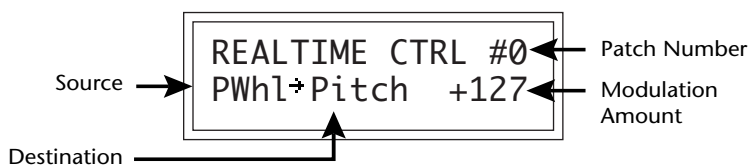

The setting shown indicates that the Pitch Wheel is connected to the Pitch, with an amount of +127 (full). Press the right cursor button (>) twice to place the cursor under the modulation source. As you slowly

••• You can think of each modulation patch as a "Cord". You must connect BOTH ends of a cord for it to work.

turn the data knob, each possible modulation source is displayed. Select LFO 1 as the Source and press Home/Enter.

Turn the data entry knob counter-clockwise until you find the LFO 1 parameter screens shown below.

```

LFO1  SHAPE  AMT
      Tri    +000
    
```

```

LFO1  RT DLY VAR
      060 000 000
    
```

Place the cursor under the Amount (AMT) parameter and set the value to +127 (you have to re-key, to hear any changes). You should be hearing lots of vibrato. Adjust the other parameters such as Rate and Shape. Controlling pitch is an easy way to hear the different LFO waveshapes. Delay (DLY) sets a time before the LFO starts. Variation (VAR) makes the rate of each LFO a little different for ensemble effects.

Now set the LFO Rate to about 20 and set the shape to "Saw". Listen

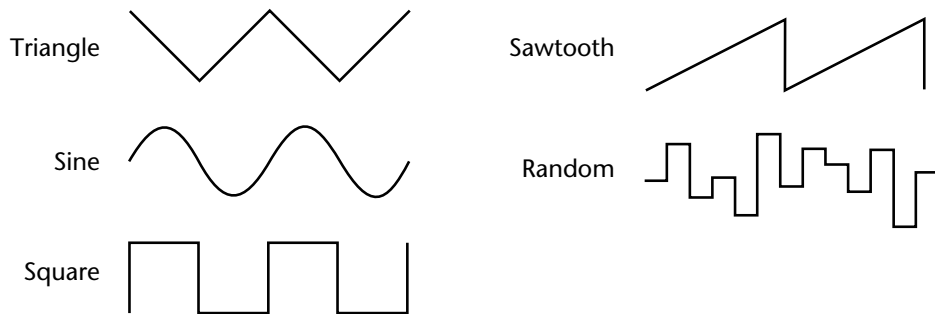

••• LFO 2 is identical to LFO 1.

how the sawtooth wave smoothly ramps up then comes abruptly down. Change the amount to -128 and notice that it now ramps down and comes abruptly back up. Anytime you use a negative amount (*in any part of Morpheus*), you *Invert* the modulation.

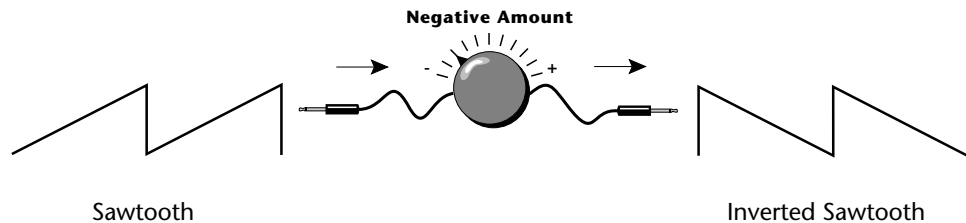

In preparation for the next experiment, set the LFO waveform to "Sine" and the rate to about "050". Leave the amount set to "-128". Press Enter.

Go back to the Realtime Modulation screen and set it as shown below.

REALTIME CTRL #0 Lfo1→Pan +127

Notice how the LFO now moves the sound from side to side. The diagram below illustrates the connection you just made.

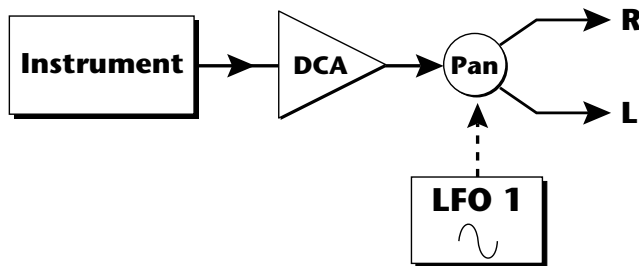

The Realtime Control screen connects ANY realtime modulation source to ANY realtime control destination! The amount parameter controls “how much” modulation is applied. Change the destination to *Volume* and listen. The block diagram for this connection is shown below.

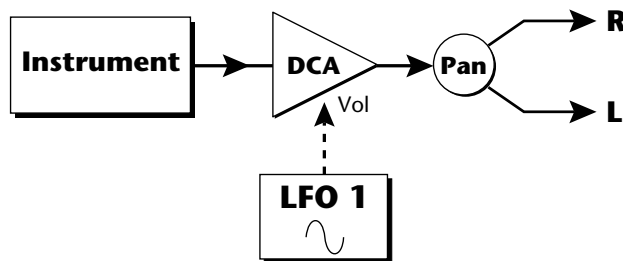

Place the cursor under the “#0” on the top line of the display. Turn the data entry knob and notice that the lower line changes with the patch number. There are TEN (count 'em) realtime modulation patches available per preset! This is what sound synthesis is all about. By simultaneously controlling many parameters, the sound is shaped in complex ways into the desired form.

✓ Now that you understand how to connect modulation sources to destinations, try using the Auxiliary Envelope Generator to control pitch. You've already used the Alternate Volume Envelope generators. The Auxiliary Envelope works exactly the same, except that it has an initial Delay stage and it can be routed to any realtime control destination.

••• An LFO modulating volume is called “Tremolo”. Tremolo is useful for organ, voice, surf guitars, etc.

••• You can think of each modulation patch as a “Cord”. You must connect BOTH ends of a cord for it to work.

• **Modulating Modulators**

Go back again to the LFO 1 screen and turn the amount to “+000”. Next turn to the Note-On Control screen and set up the screen to look like the one below.



The connection you just made is shown below.

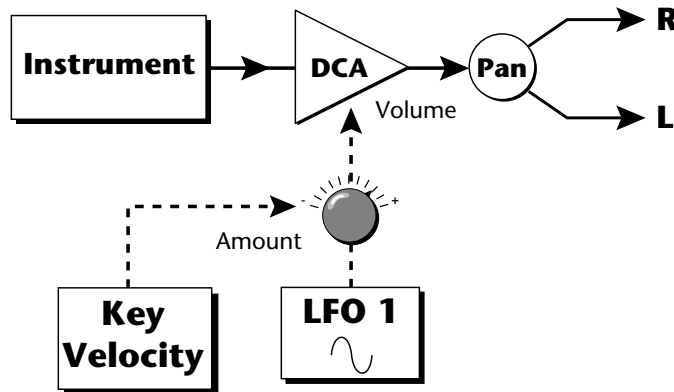

Play the keyboard hard and then softly. The key velocity is controlling the amount of LFO applied to the volume. The harder you play, the more LFO modulation is applied. The modulation wheel (Realtime Control screen) can also be routed to control the LFO 1 amount, or the LFO rate or the Pan position, or all of the above. There can be ten Note-On modulations and ten Realtime modulations in each preset.

You can probably see why patch diagrams are important (even if they only exist in your mind). They allow you to visualize how the connections are being made inside Morpheus.

• The Morpheus Filter

This is what a lot of you have been waiting for. This incredible filter is what puts the Morph in Morpheus. *If you have not read the section on the Z-Plane Filter in the Preset Programming section, please do so before proceeding, since it contains important background information.* Now we can add the Z-Plane filter to our block diagram.

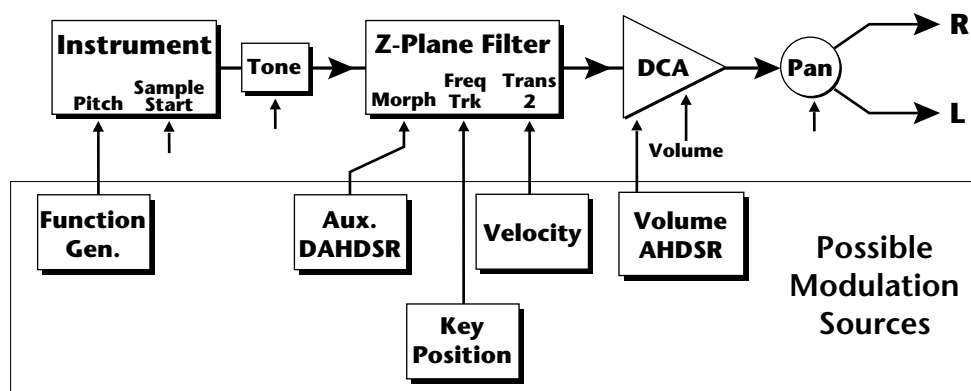

Let's examine the filter controls more closely. The vertical arrows in the diagram below, indicate controls that can be modulated. The Morph Offset is the only filter control that can be modulated continuously by a Realtime Control source.

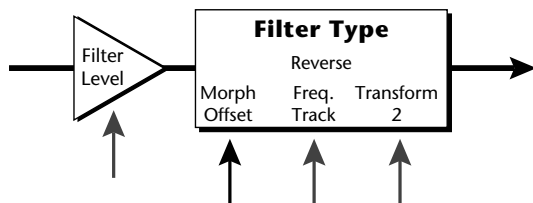

The filter has an input level control called the *Filter Level* which controls how much signal is presented to the filter. This control (like most of the controls in Morpheus) has an initial amount and can also be controlled from a Note-on modulation source. Certain Morpheus filters are designed to distort the signal as a musical effect. The Filter Level allows you to control the amount of distortion produced by these special filter types.

The action of the *Morph Offset* varies from filter to filter. Because it can be continuously varied, it can be thought of as the main filter control. See the section on Morpheus Filters in the Reference Section of this manual for specific information on each filter.

The *Frequency Tracking* control changes the frequency of the filter on many of the filter types. This would correspond to F_c or the cutoff frequency of a traditional lowpass filter. You can connect the keyboard to this control (in the Note-on Control screen) with an amount setting of "64" if you want the filter frequency to track the keyboard.

••• *Frequency Tracking does not always control frequency as the name would imply. See the Z-Plane Filter Descriptions in the Reference Section for details on each filter type.*

••• Note: Filter Frequency Tracking is Transform 1.

▼ Many of the Z-plane filters do not use Transform 2.

••• Information on connecting MIDI controllers can be found at the end of the Programming Basics section.

Key tracking is used to keep the timbre of the sound constant as you play up and down the keyboard. Of course, you can route any Note-On controller to control Frequency Tracking.

Like the Morph control, the effect of *Transform 2* varies from filter to filter and in many cases it is not used at all. On a simple lowpass filter, Transform 2 might be used as a Q (or resonance) control. On a flanger, it might control the depth of the notches. The Z-plane filter descriptions in the Reference Section give specific information on the function of Transform 2 in each filter.

Just Do It!

OK. Let's start experimenting with the filters. First, we should connect the modulation wheel to control Morph so that it will be easy to hear the effect of this important parameter. Start with a clean slate by selecting the default preset again. Enter the Preset menu and select an instrument rich in harmonics such as "I004 PunchyBrass".

The mod wheel is usually transmitted on MIDI controller 01. Morpheus Controller A is set to controller 01 by default. So if you have not changed this parameter in the Master menu, Controller A is the mod wheel. We want to route Controller A (the mod wheel) to Morph. Go to the Realtime Modulation Control screen and set it as shown below.



```
REALTIME CTRL #1
Ct1A ↗ Morph +127
```

Note: A good way to verify that the mod wheel is connected is to set the destination (in the screen above) to "Pitch" instead of "Morph". Move the wheel to verify that the pitch varies with the wheel. If so, change the destination back to "Morph".

Move to the "Primary Filter Type" screen and scroll through the various filters as you play the keyboard. Move the modulation wheel and verify that the wheel is controlling the morph parameter. For this experiment, set the filter type to "F029 Vocal Cube". This is an interesting filter and since it is a "cube", it has three parameters to adjust.



```
FILTER TYPE pri
F029 Vocal Cube
```

Move to the “Filter Frequency Tracking” screen and adjust the primary offset while playing the keyboard. (You must re-key the keyboard to hear the results of changing this value.) As specified, this parameter changes the frequency of the filter, making it brighter as the value is increased. Feel free to adjust the morph parameter as you adjust frequency tracking.

```
FILT_FREQ_TRACK
pri:127  sec:000
```

Next we'll adjust “Filter Transform 2”. On this filter, Transform 2 increases the size of the peaks in the vocal formant. The effect of increasing the peaks is a pronounced “nasal” quality which is quite dramatic.

```
FILT_TRANSFORM_2
pri:127  sec:000
```

Now that you've explored the three main filter parameters, let's go back and connect the keyboard to “Filter Frequency Tracking”. The keyboard is a Note-On control. A setting of “064” is the proper setting for accurate key tracking where the timbre will remain more or less constant up and down the keyboard.

```
NOTE-ON_CTRL #0
Key ↗ FrqTrk +064
```

As long as we're programming Note-On Controls, go ahead and connect Velocity to Transform 2. The screen is shown below.

```
NOTE-ON_CTRL #1
Vel ↗ Trans2 +127
```

The timbre of the sound should now change as the keyboard is played hard and soft. Transform 2, Frequency Tracking, and the Morph are all highly interactive, so a fair amount of adjustment may be required to get the sound just right.

••• *Feel free to change the instrument at any time during these experiments. They are just that, Experiments!*

• **Filter Philosophy**

The Instrument and the Filter work together to determine the harmonic content of the final sound. You can think of the instrument like clay which is being squeezed through a die, the filter. The filter tries to impress its structure on the harmonics of the instrument.

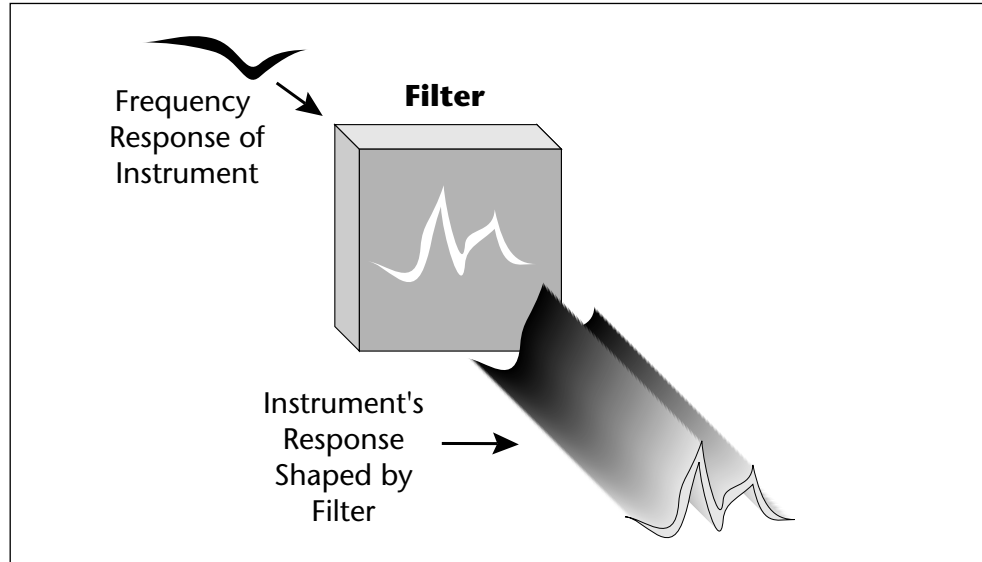

Of course, the filter cannot amplify or attenuate frequencies which do not exist in the original instrument. The Filter Frequency Tracking control can be used to “tune in” the filter to match the instrument.

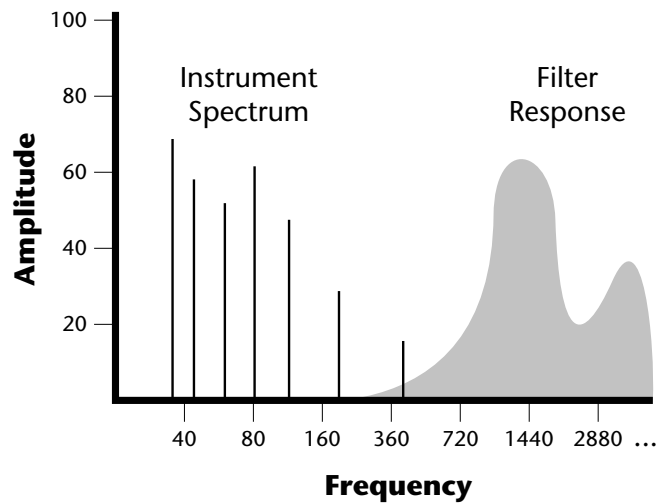

The Filter can only act on frequencies that are present in the Instrument. Use the Filter Frequency Tracking control to “fine tune” the filter to the instrument. No sound would be output from the example above because the filter’s frequency response and the harmonic spectrum of the instrument do not coincide.

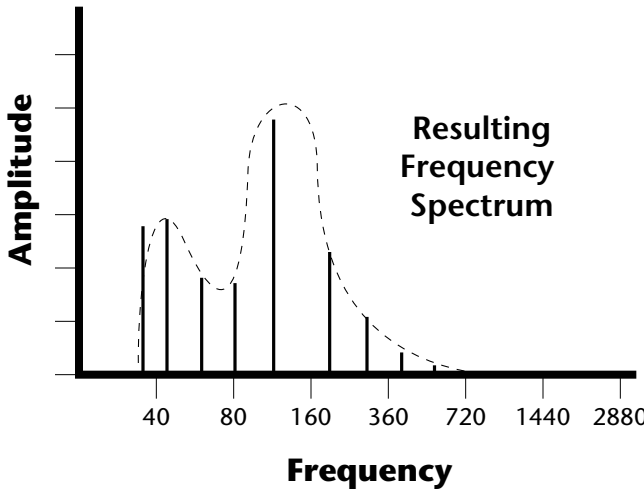
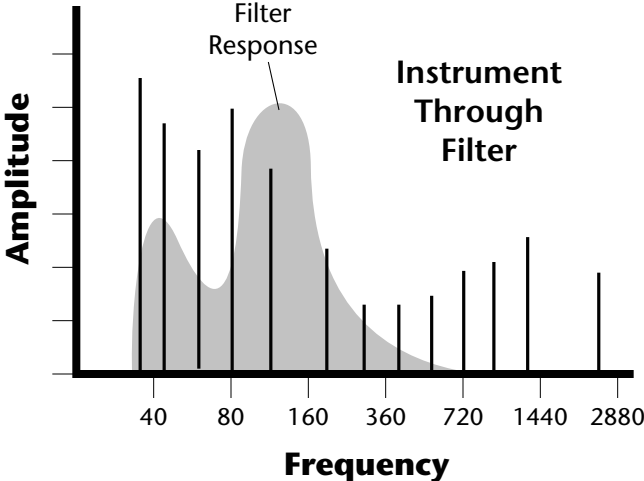
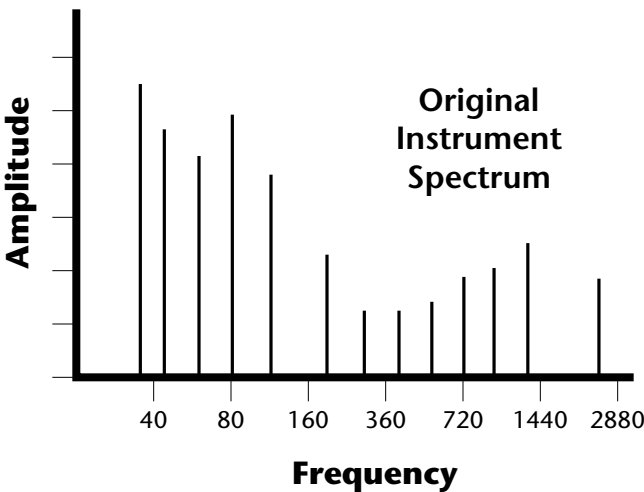

The Filter imposes its response on the harmonic spectrum of the Instrument.

To illustrate the point, let's create a complete sound from scratch as an example of how the various parameters combined with the Z-plane filter can radically alter an instrument. In this case we'll try running a saxophone through a clarinet and oboe filter using only the primary layer. As in previous experiments, start with the default preset and change only the parameters listed.

Sax-Obonet (pri only)	
Instrument: 014 Tenor Sax 1	Note-On Ctrl
Alt Envelope: On	0 Key -> Freq. Trk +064
A H D S R	1 Vel -> Trans2 +080
00 00 00 99 03	2 Vel -> ToneP -100
Double + Detune: 4	3 Vel -> VolumeP +049
Filter Type: 085 Clr>Oboe	Realtime Ctrl
Morph Offset: 000	1 Ctl A -> Morph +127

The Tenor Saxophone is an instrument rich in harmonics, making it ideal for filtering. Double + Detune has been turned on to make the sax sound a little “fatter”, and the Alternate Volume Envelope has been adjusted slightly for a fast attack and release. The filter type is 085 Clarinet->Oboe, which models the resonance characteristics of a clarinet and morphs into the resonance of an oboe. On this particular filter, Transform 2 controls a lowpass filter and increases the volume slightly (more T2 equals brighter and louder). The Morph Offset is turned down to 000 so that it can be turned back up using Controller A (which defaults to the Mod Wheel of your keyboard.). Control A has been routed to control the filter Morph in the Realtime Modulation Control.

Now to the Note-On modulation. The Key Number has been routed to Key Tracking with the standard setting of +064. This keeps the tone constant as you play up and down the keyboard. Velocity has been routed to Transform 2, which will make the sound brighter and louder as you play harder. Velocity controls the Tone using negative modulation to slightly mute the sound with soft playing and controls volume to increase the volume with hard playing.

This is just a simple example to get you started. To learn more about how great presets are constructed, examine the factory presets in detail and discover their secrets. Interesting and expressive sounds have many different controls occurring simultaneously. In creating a preset, you are actually designing a new musical instrument. Take the time to fine tune and polish your creation!

• *Morphology*

The best and ultimately the only way to choose filters is to try them out. Morpheus is no mere mortal synthesizer with a single filter. Morpheus has 197 filter types to choose from. Think of the filters as you do instruments: entities which have a particular sound. As you learn what the instrument and the filters sound like, you can mix and match them to suit your needs.

- A flanger filter (which is a parametric EQ with closely-spaced notches) sounds like a traditional flanger when swept. If the frequency of the flanger is controlled by key velocity and not swept, the flanger can simulate different plucks on a string or strikes on a surface such as a cymbal.
- The need for Keyboard Tracking is reduced when using a parametric EQ since the high frequencies are preserved (unlike a lowpass filter).
- Time-variant filter sweeps are good for traditional synthesizer effects such as resonant sweeps, flanges, phasing, stereo panning, vowels, etc. Time-invariant filters are useful for distortion, simulating instrument resonances, plucked strings, cymbals strikes, etc.
- Correlate the DCA envelope to emphasize or minimize parallel filter attack and release characteristics.
- Try using vibrato (LFO to pitch) with vocal filters for more realistic vocal simulations.
- Velocity and Key Number generally alter the timbre in expressive presets. Also, Harder (faster) usually equals Brighter.
- Natural sounds tend to use low Q filters.
- **Fixed Formant Filters:**
 - Can reduce the unwanted effect of pitch shifting the samples (munchkinization).
 - Simulate instrument body resonances
 - Simulate cymbal strikes, with variation in the stick position
 - Simulate woodwind instrument resonance
 - Simulate guitar and string plucks with variation in pick position
- **Swept Filters:**
 - Flanger
 - Traditional Synthesizer Lowpass Filter Effects

USING MORPHEUS WITH A SEQUENCER

We thought you'd never ask. Morpheus was designed from its conception with multi-timbral sequencing in mind. Just take a look at the main screen.

C01 VOL127 PAN=P
000 Program Name

The preset for each MIDI channel is selected from the main screen or from the Midimap menu which stores sixteen (32 with a RAM card installed) complete 16-channel MIDI setups. The Main Screen settings are the same settings in the currently selected Midimap and any changes you make will be reflected in either screen. Press the cursor button to move the cursor up so that it is underneath the channel number.

C01 VOL127 PAN=P
000 Program Name

Turn the data entry control and you will see that every MIDI channel has a preset assigned to it. Just select a preset or hyperpreset for each of the MIDI channels. It's simple! If you want to store the sixteen channel MIDI setup, press the Midimap button and turn the data entry control to the last screen, "Save Midimap to". Then select a location and press Enter.

In order to respond to multiple MIDI channels, Morpheus must be in Multi-Mode. Multi-Mode is selected in the Master menu. Press the Master menu button and use the data entry control to scroll through the screens until you find MIDI MODE.

MIDI MODE	ID
Multi	00

Move the cursor down to the second line and change the mode to **Multi** as shown. Morpheus will now respond to multiple MIDI channels.

MORE ADVANCED SEQUENCING

• *Pre-Sequence Setup*

Suppose that you want to have your sequencer set up everything for you before the start of the song. Good idea. This will make the Morpheus setup procedure automatic and prevent the wrong presets from playing.

The basic idea of a pre-sequence setup is to send out a Midimap Select command just before the start of the song. Your pre-programmed Midimap will select all the proper presets, adjust the mix and effects settings as well as the pan positions of each preset.

Most computer-based MIDI sequencers have the ability to send MIDI SysEx data. The ONLY way to select a Midimap remotely is to use a SysEx message. Consult your sequencer operation manual for information on sending SysEx messages.

Note: Morpheus setup information should be transmitted from the sequencer *before* the song actually starts, perhaps during a lead-in measure or countdown. DO NOT send setup information just before the first beat of the song or MIDI timing errors could result.

• *Initial Setup*

- 1) Program a Midimap exactly the way you want it, with Channels to Preset/Hyper, MIDI Enables and Effect Settings. Be sure to name your Midimap so you can recognize it later.
- 2) SAVE the Midimap in one of the sixteen internal locations or one of the sixteen RAM card locations.
- 3) Make sure the Device ID (MIDI Mode in the Master menu) is set to 00. Otherwise Morpheus will simply ignore the SysEx messages.

• *Before the Sequence Starts*

Send the following MIDI SysEx messages exactly as listed.

- 1) Turn On Multi-Mode - **Send: F0 18 0C 00 03 08 02 02 00 F7**
- 2) Select the Midimap - **Send: F0 18 0C 00 03 40 02 02 00 F7**

Use the chart at right to find the proper "Hex" number (in **Bold**) to insert into the MIDI string. For example, to select Midimap 10, you would insert the hexadecimal number "0A" in the position shown above.

Now your song will play perfectly every time according to the parameters in the Midimap. In addition, programs, volumes and pan positions (or anything else for that matter) can be adjusted in realtime during the song using standard MIDI controllers. Note: If the wrong programs are being selected, check the MIDI Program Change Map.

••• To Change Program Banks via MIDI SysEx, send:

Bn 00 00 20 ll Cn pp

n = MIDI chan. number (0-F)

ll = Bank number (00-04)

pp = Preset in the new bank (00-7F)

••• Note: Device ID 00 is only necessary for the example shown below. Device IDs are used to differentiate multiple Morpheus units on the MIDI cable.

Midimap Number

Map	Hx	10 =	0A	21 =	15
00 =	00	11 =	0B	22 =	16
01 =	01	12 =	0C	23 =	17
02 =	02	13 =	0D	24 =	18
03 =	03	14 =	0E	25 =	19
04 =	04	15 =	0F	26 =	1A
05 =	05	16 =	10	27 =	1B
06 =	06	17 =	11	28 =	1C
07 =	07	18 =	12	29 =	1D
08 =	08	19 =	13	30 =	1E
09 =	09	20 =	14	31 =	1F

• **Using the 32 Channels**

As stated earlier, Morpheus has 32 independent audio channels which are utilized dynamically. With 32 channels and hundreds of sounds, you have a universe of sonic textures at your disposal. You may have noticed that many of the very “big” sounding hyperpresets in Morpheus are constructed using layered presets or they may use Double+Detune. While this is fine when the hyper is played solo, you may begin to run out of channels when Morpheus is played multi-timbrally. Layered hyperpresets and the Double+Detune function cause extra output channels to be used. Learn to “budget” your output channels for maximum efficiency.

• **Channel Ripoff**

When Morpheus uses up all its 32 channels and needs more, it steals a channel from the key that has been held the longest. This is commonly known as “channel rip-off”. You will most commonly encounter this “rip-off” when using Morpheus in multi-timbral mode or when using massive hyperpresets. Long Alternate Envelope attack and release rates can also cause this problem. Since Morpheus dynamically allocates channels as needed, you must either, play fewer notes, shorten the release rates, use simpler sounds, or turn off Double+Detune to eliminate channel rip-off.

• **Using External Processing**

Don't be afraid to use external processing on specific sounds if you feel the urge. The submix sends and returns on Morpheus are there for a reason. In certain instances, a little external signal processing will be just the thing an instrument needs to give it a distinct identity. Incidentally, a real guitar or bass amp can work wonders on the guitar and bass sounds. If you think about it, playing these sounds through an instrument amp is much closer to the way they are normally processed. Because the submix outputs are programmable, only selected presets or MIDI channels will be routed to the guitar amp.

••• Use the effects section to “fatten” your sound instead of the chorus feature in the preset. This will help conserve precious voice channels.

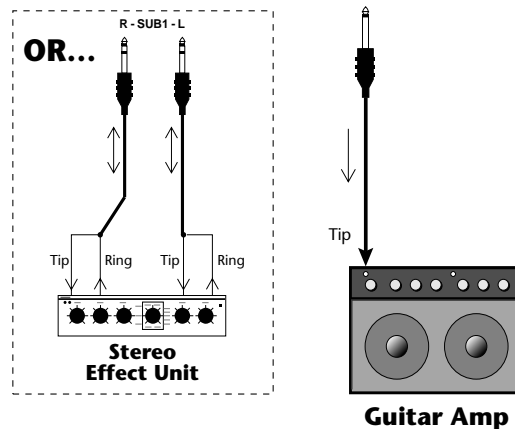
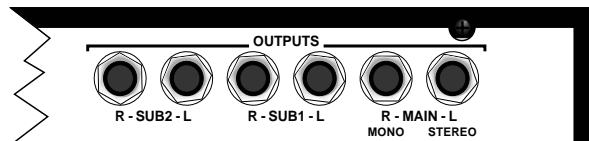

Using the programmable outputs and returns, specific presets can be routed through outboard processors without using up precious mixer channels.

**REFERENCE
SECTION**

FACTORY RAM PRESETS - BANK 0

MORPH

- 0. Z-Synth
- 10. Klav Klipper
- 11. Flute Too
- 12. Air String
- 13. Voices
- 14. Whisper
- 15. Rhythm Of Life
- 16. Metal Mlt
- 17. Phazbraz
- 18. Rezz Slither
- 19. SteinChoral

PAD

- 3. Strings
- 40. Synth River
- 41. BrassKin
- 42. Huge String
- 43. Synth Morph
- 44. Strang Thang
- 45. Mechanik
- 46. Leslike
- 47. Weird B3
- 48. Flange String
- 49. Eden Drone

LEAD

- 6. Grunge
- 70. Sync Lead
- 71. Cheap Trick
- 72. Pulse Lead
- 73. Sinnleed
- 74. Metal Growl
- 75. Synthle
- 76. Stoked Up
- 77. Hooh Zayr
- 78. Nyles Song
- 79. Mallet

DRUM

- 9. Sweep
- 100. House
- 101. Skritch
- 102. Reversa
- 103. Scratch
- 104. My Kick
- 105. Kicks
- 106. Snares
- 107. CymNoiz
- 108. Congas
- 109. Alien

REAL

- 1. Piano Vibe
- 20. Piano
- 21. E. Piano
- 22. Steinway Bass
- 23. Flute
- 24. Mute Me
- 25. Misty Vibe
- 26. Expr Acou. Guitar
- 27. String<Chorus
- 28. Brass String
- 29. Stein Tine

BASS

- 4. UpRight
- 50. Bozo250
- 51. Fat Sawz
- 52. Selazap
- 53. Bassa
- 54. Grindge
- 55. Q Fall
- 56. Some
- 57. Headcase
- 58. Form
- 59. Acous & Elect

ATMOSPHERE

- 7. Rave Gruv
- 80. Astralix
- 81. Nova Arp
- 82. Mosaic
- 83. Lunar Arp
- 84. Heavens Gate
- 85. Ferrous
- 86. Koto Breath
- 87. Vulkan Vowel
- 88. Movie
- 89. Flute Duo

SOUND FX

- 110. Sonik Synth
- 111. Noise Band
- 112. Velimba
- 113. S/H
- 114. Hemlock
- 115. Wormhole
- 116. Manic Jig
- 117. Da Radio
- 118. Drumble
- 119. Dipped Metal

COMP

- 2. Electric Piano
- 30. Chik Willy
- 31. 2 Pianos
- 32. Ring Fire
- 33. Tine Organ
- 34. Syntaks
- 35. Puck Muff
- 36. Organic
- 37. Vell Bell
- 38. Cookin'
- 39. Ear Candy

GUITAR

- 5. Trippy
- 60. Santa Cruz
- 61. New Dist.
- 62. String Ring
- 63. Expressive
- 64. Wheel
- 65. Guitarzan
- 66. Thunder Tar
- 67. Harntoo
- 68. Flang Strat
- 69. Pick It

VOCAL

- 8. Why?
- 90. Flange Vox
- 91. Angel Heart
- 92. Cirrus
- 93. Uman String
- 94. Erica's
- 95. Oz Boiz
- 96. Vox Sweep
- 97. Amazon
- 98. Wow Man
- 99. Window Pane

TEKNO

- 120. Omatika
- 121. Oral Oscillate
- 122. Java Tea
- 123. Razor Slice
- 124. Ravia Maj
- 125. Bell Epic
- 126. Krazy Rom
- 127. -defPreset-

MORPH

- 0. Morpheus
- 10. Phat Sky
- 11. Swell Pad
- 12. Windy Pip
- 13. Organ/Bass
- 14. Harpog
- 15. Sethy Sax
- 16. Sax Change
- 17. Shoop Dee
- 18. Picknal
- 19. SynBrass

PAD

- 3. Ball Heavies
- 40. Swirly
- 41. Centered
- 42. Oasis
- 43. Epic Moment
- 44. Weird Beard
- 45. Hough Finger
- 46. Beauty
- 47. Krone Wave
- 48. String Swell
- 49. FunkShun

LEAD

- 6. Flute Morph
- 70. Jupiter Synth
- 71. Big Hooter
- 72. Barri Q
- 73. Jazz Synth
- 74. Talk Flute
- 75. JX Touch
- 76. Crunchy
- 77. Whofs
- 78. Reasonable
- 79. Brute Emu

DRUM

- 9. Dance
- 100. New Jacq
- 101. Snare
- 102. Lo<Drum
- 103. Hi<Drum
- 104. Morphie
- 105. Notch
- 106. Sweep
- 107. Reverse
- 108. Deep Power
- 109. China

REAL

- 1. PianoVibe
- 20. Ambient Piano
- 21. Z Piano
- 22. UpRight
- 23. Pick Eldora
- 24. Mute Me
- 25. String/Brass
- 26. Pop Brass
- 27. Vibes
- 28. Double Bari
- 29. Flute

BASS

- 4. Sweep
- 50. Noir
- 51. Deep
- 52. The Q
- 53. Expanse
- 54. Breath
- 55. Thick
- 56. Friend
- 57. My Pulse
- 58. SawBass
- 59. Emu Mod

ATMOSPHERE

- 7. Atmorphs
- 80. Twit Pink
- 81. Ethereal Air
- 82. Ethereal Keys
- 83. Synth
- 84. Phobia
- 85. Air Flange
- 86. WaveMerge
- 87. Fools Water
- 88. Noise E!
- 89. AirWaves

SOUND FX

- 110. Computer String
- 111. Bean Machine
- 112. Bass Drum
- 113. Snare Drum
- 114. Shaker
- 115. WhatYeah
- 116. Jaw Mama
- 117. Space Gum
- 118. DidgDink
- 119. Gruf Rumble

COMP

- 2. Electric Piano
- 30. Yeaowaho
- 31. Vox Organ
- 32. PianoStik
- 33. No Quarter
- 34. Elekt Piano
- 35. Hot Jazz
- 36. Schnap
- 37. Pad/Clav
- 38. Snowfall
- 39. Muf Horton

GUITAR

- 5. Trippy
- 60. Riphust
- 61. Electric
- 62. Mouth
- 63. Acoustic
- 64. Santa Cruz
- 65. Harmonix
- 66. Expressive Ac.
- 67. Slip Pick
- 68. Distort
- 69. Fuzz Tone

VOCAL

- 8. Vocal Wheel
- 90. Big Will
- 91. Noise Vowl
- 92. Yah Synth
- 93. Yuppies
- 94. Hissing
- 95. Chorus Vowel
- 96. Breathy Vowel
- 97. Pulse
- 98. Morfy Yes
- 99. Vox Pad

TEKNO

- 120. LeadMeOn
- 121. Woofer
- 122. Blaster
- 123. FX
- 124. Poundage
- 125. Shame
- 126. Rave
- 127. -defPreset-

SAMPLED SOUNDS

- 1. Dance Drums 1 | See the **Percussion Instrument Location Diagrams** on page 168.
- 2. Dance Drums 2
- 3. Dancer Synth
- 4. Punchy Brass
- 5. Spectrum Pad
- 6. Vox Choir
- 7. Jupiter String
- 8. Orchestral String 1
- 9. Orchestral String 2
- 10. Acoustic Guitar
- 11. Acoustic Guitar 2
- 12. Acoustic Guitar 3
- 13. Silver Flute
- 14. Tenor Sax 1
- 15. Tenor Sax 2
- 16. Bari Sax
- 17. Soprano Sax
- 18. Alto Sax
- 19. Metal String
- 20. Gutt Bass
- 21. Upright Bass
- 22. Upright Bass 2
- 23. Fretless
- 24. Quick Bass
- 25. Cool Vibe
- 26. Bright Vibes
- 27. Vibe Stik
- 28. Crotales
- 29. Peking
- 30. Java Malet
- 31. Kenong
- 32. Icy Pad
- 33. Bright Electric Piano
- 34. Piano Bright
- 35. Piano Medium 1
- 36. Piano Medium 2
- 37. Piano Dark
- 38. Rock Organ
- 39. Clean Strat
- 40. Harmonics
- 41. Bass Harmonic
- 42. Electric Bass 1
- 43. Electric Bass 2
- 44. Electric Bass 3
- 45. Electric Bass 4
- 46. Electric Bass 5
- 47. Electric Bass 6
- 48. Electric Bass 7

STANDARD SYNTHESIZER WAVEFORMS

- 49. Sawtooth
- 50. Square
- 51. Pulse 50%
- 52. Pulse 75%
- 53. Pulse 90%
- 54. Pulse 94%
- 55. Pulse 96%
- 56. Pulse 98%
- 57. Pulse 99%
- 58. Noise
- 59. Oct 3rd White Noise
- 60. Triangle

HARMONIC WAVEFORMS

- 61. Oct 1 (Sine)
- 62. Oct 2 All
- 63. Oct 3 All
- 64. Oct 4 All
- 65. Oct 5 All
- 66. Oct 6 All
- 67. Oct 7 All
- 68. Oct 2 Odd
- 69. Oct 3 Odd
- 70. Oct 4 Odd
- 71. Oct 5 Odd
- 72. Oct 6 Odd
- 73. Oct 7 Odd
- 74. Oct 2 Even
- 75. Oct 3 Even
- 76. Oct 4 Even
- 77. Oct 5 Even
- 78. Oct 6 Even
- 79. Oct 7 Even
- 80. Low Odds
- 81. Low Evens
- 82. Four Octaves

Starting from the first octave (fundamental), the harmonic waveforms contain the harmonics (odd, even, or all) present in each octave. In each successive octave, the number of harmonics doubles. By combining (pri/sec or link) the harmonic waveforms in various amounts (volume), and transposing them (course/fine tuning), a wide range of timbres may be produced.

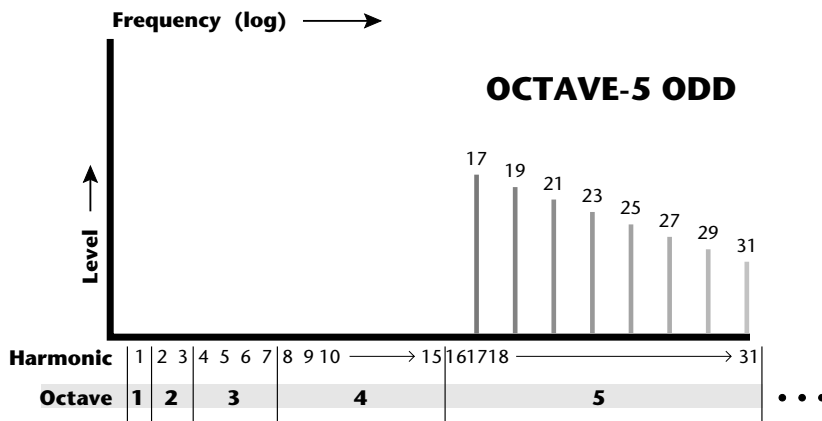

As an example, this chart shows the harmonics present in the **Octave 5 Odd** waveform.

SYNTHESIZER & ORGAN WAVEFORMS

Single cycle waveforms are sampled waves from various synthesizers and organs. Waveforms highlighted in **Bold** lettering are multicycle samples. The others are single cycle waveforms. B3 waves are various harmonic drawbar settings designed to be used alone or layered.

- | | |
|------------------------|-----------------------------|
| 83. B3 Wave 1 | 113. Organ Cycle 2 |
| 84. B3 Wave 2 | 114. Violin Essence |
| 85. B3 Wave 4 | 115. Buzzoon |
| 86. B3 Wave 5 | 116. Brassy Wave |
| 87. B3 Wave 6 | 117. Woofer Pulse |
| 88. Organ Wave 1 | 118. Trumpet Waves 1 |
| 89. Organ Wave 2 | 119. Trumpet Waves 2 |
| 90. Barber Pole | 120. Trumpet Waves 3 |
| 91. Synth Cycle 1 | 121. Reedy Buzz |
| 92. Synth Cycle 2 | 122. Growl Wave |
| 93. Synth Cycle 3 | 123. HarpsiWave |
| 94. Synth Cycle 4 | 124. Fuzzy Gruzz |
| 95. Fundamental Gone 1 | 125. Power 5ths |
| 96. Fundamental Gone 2 | 126. Reson TG |
| 97. Bite Cycle | 127. Hollow Whisp |
| 98. Buzzy Cycle | 128. Metal Whisp |
| 99. Metalphone 1 | 129. Formant Axe |
| 100. Metalphone 2 | 130. Crunchy Lead |
| 101. Metalphone 3 | 131. Sync Lead |
| 102. Metalphone 4 | 132. Pulse Sweep |
| 103. Tine Wave | 133. Pulse Wave |
| 104. Duck Cycle 1 | 134. Emu Modular 1 |
| 105. Duck Cycle 2 | 135. Emu Modular 2 |
| 106. Duck Cycle 3 | 136. Mini MOOG |
| 107. Theremin Saw | 137. Saint Moog |
| 108. Wind Cycle 1 | 138. Analog Bass |
| 109. Wind Cycle 2 | 139. Liquid Moog |
| 110. Wind Cycle 3 | 140. Quake Bass |
| 111. Wind Cycle 4 | 141. Q Bass |
| 112. Organ Cycle 1 | 142. Luxury Bass |

- 143. Reson Bass 2**
- 144. Deep Bass**
- 145. Eight 0 Eight**
- 146. MOOG Wave 1**
- 147. MOOG Wave 2**
- 148. MOOG Wave 3**
- 149. EMU RECTIFIER 1**
- 150. MOOG RECTANGLE 1
- 151. MOOG RECTANGLE 2
- 152. MOOG RECTANGLE 3
- 153. MOOG RECTANGLE 4
- 154. MOOG RECTANGLE 5
- 155. Ring Mod Wave**
- 156. Ice Bell
- 157. Bronze Age
- 158. Iron Plate
- 159. Aluminum
- 160. Lead Beam
- 161. Steel Xtract
- 162. Winter Glass
- 163. Ice Wash**
- 164. Hollow Wash**
- 165. Cluster**
- 166. Swirly**
- 167. Nyles Noise**
- 168. Mellow Pad**
- 169. Syn String 1**
- 170. Syn String 2**
- 171. Syn String 3**
- 172. Thick String Wave**
- 173. Silk Veil**
- 174. Mecha Vox**
- 175. Techno Vox**

PERCUSSION INSTRUMENTS

- 176. Rack Bell
- 177. Solder Sucker
- 178. Rasp Shaker
- 179. Iron Rattle
- 180. Burst Hats
- 181. Vise Grips
- 182. Record Scratch 1
- 183. Record Scratch 2
- 184. Record Scratch 3
- 185. Record Scratch 4
- 186. Record Scratch 5
- 187. Record Scratch 6
- 188. Record Scratch 7
- 189. Modular Scratch
- 190. Distorto Kick
- 191. Beef Kick Rap
- 192. Bass 909 #2
- 193. High Snare
- 194. Snap Snare
- 195. Snare 3
- 196. Crushed Snare
- 197. Noise Hat
- 198. Bass Drum
- 199. Kick 909
- 200. Kick 909 #2
- 201. Dry Bass Drum
- 202. Liquid Drum
- 203. Power Kick
- 204. Cowbell
- 205. Tamb707Noiz
- 206. Shaker 808
- 207. Shaker 2
- 208. NoizTambHit
- 209. Open Hat
- 210. Foot Hat
- 211. Tip Hat
- 212. Hi Hat 808
- 213. Open Hi Hat
- 214. Closed Hat
- 215. Hip Hat
- 216. Hip Hat 2
- 217. Rim Shot
- 218. Snare Drum 1
- 219. Snare Drum 2
- 220. Snare 808
- 221. Rim 808 Shot
- 222. Electric Snare 4
- 223. ROB 808 Claps
- 224. Dry 909 Clap
- 225. Open Hat 909
- 226. Closed Hat 909
- 227. Shaman Snare 1
- 228. Shaman Snare 2
- 229. Shaman Snare 3
- 230. Ware Snare
- 231. Snare 5
- 232. Snare 909 1
- 233. Snare 909 2
- 234. Film Click
- 235. All Kicks
- 236. All Snares
- 237. Hats & Noise
- 238. Rap Scratch A
- 239. Rap Scratch B
- 240. Conga Hits
- 241. Clave Log Drum
- 242. Combined Hit

See the **Percussion Instrument Location Diagrams** on the following pages.

DRAWBAR DIAGRAMS

Each drawbar controls the volume of its associated harmonic or overtone. The 8' drawbar is the fundamental pitch of the sound.

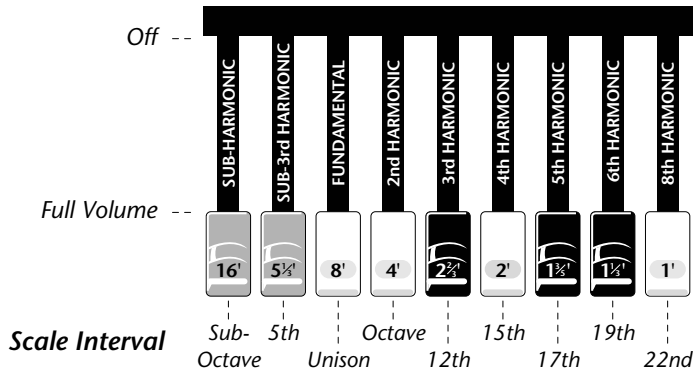

B3 Wave 1

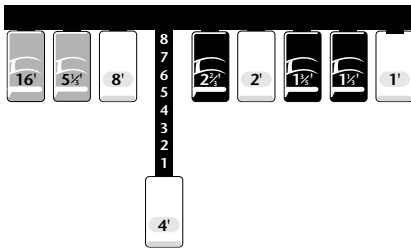

B3 Wave 2

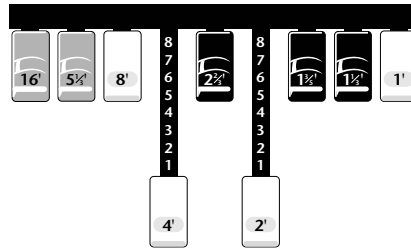

B3 Wave 4

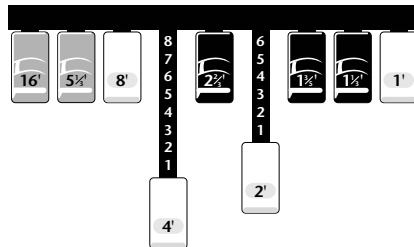

B3 Wave 5

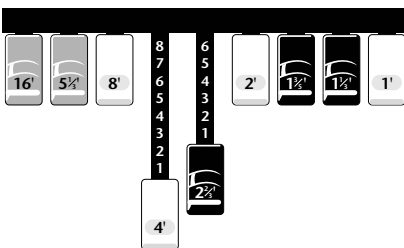

B3 Wave 6

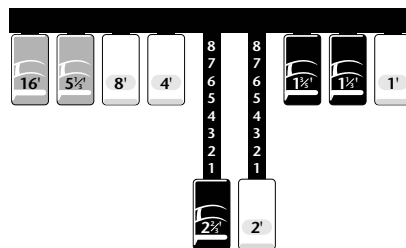

••• You can add animation to the single cycle waves by modulating their pitch or volume with the LFO.

PERCUSSION INSTRUMENT LOCATIONS

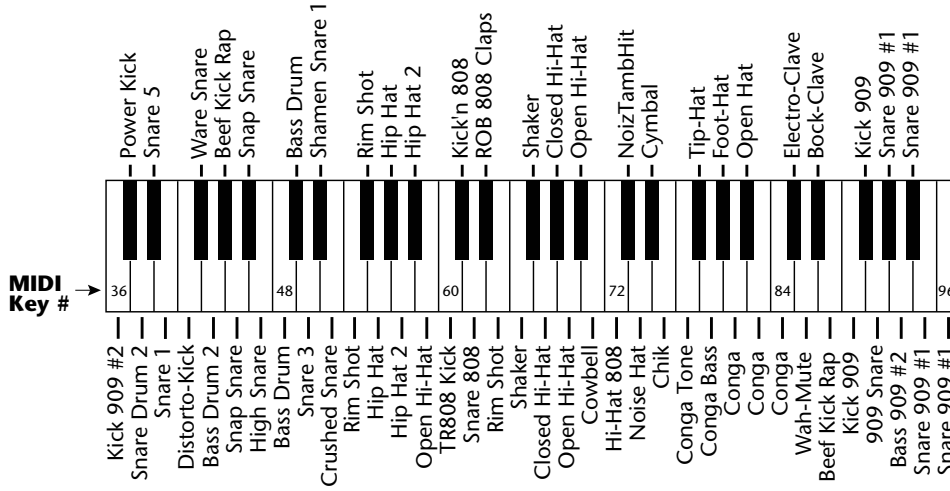

Dance Drums 1
Instrument 001

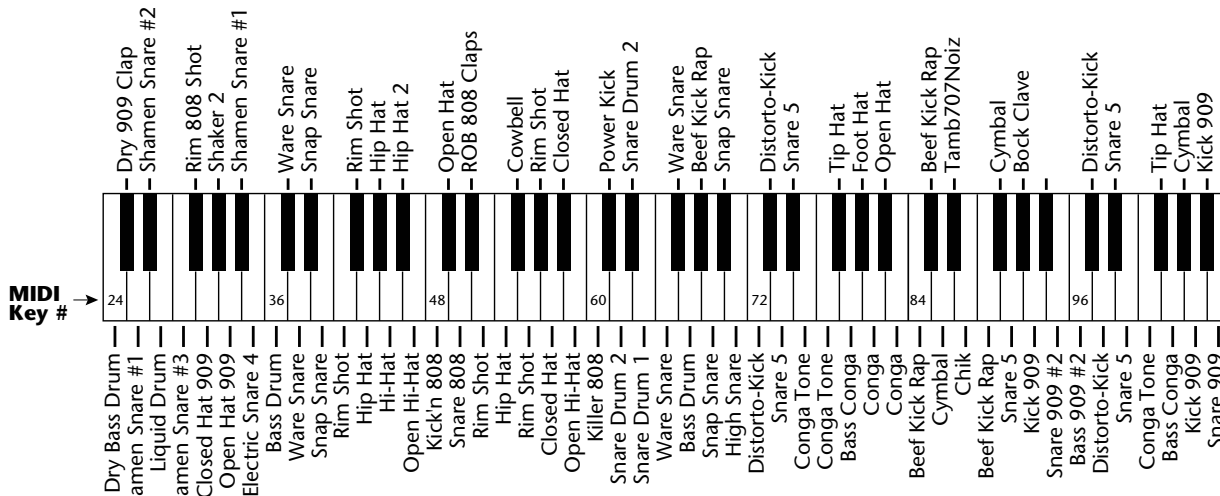

Dance Drums 2
Instrument 002

PERCUSSION INSTRUMENT LOCATIONS

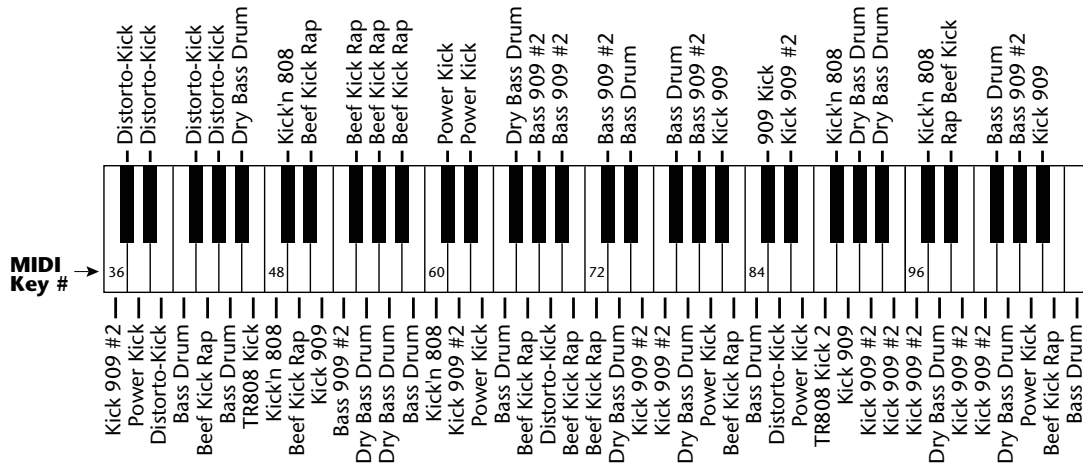

All Kicks Instrument 235

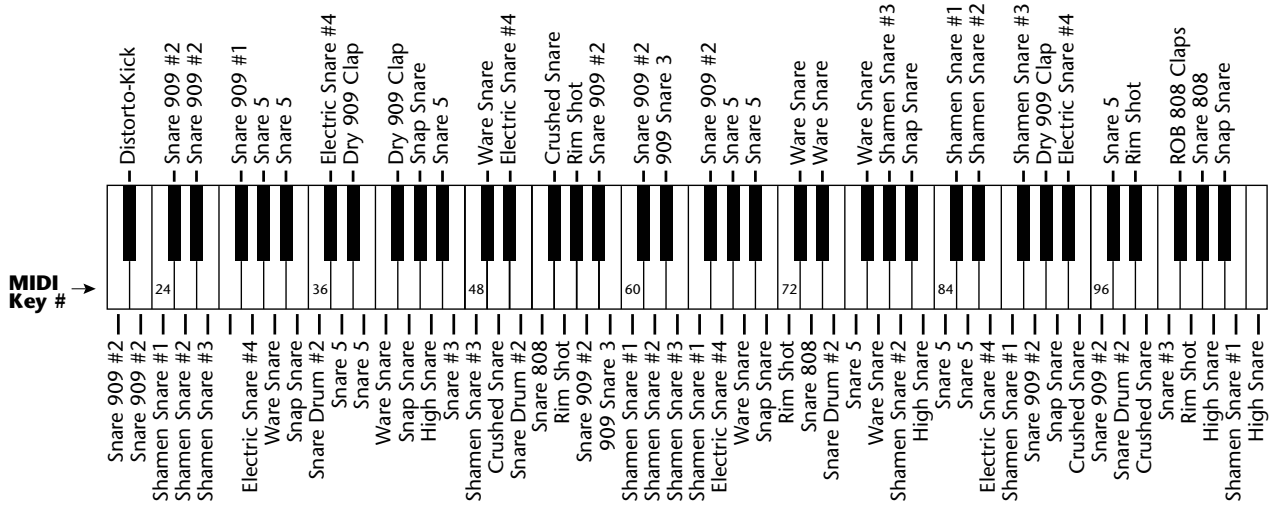

All Snares Instrument 236

PERCUSSION INSTRUMENT LOCATIONS

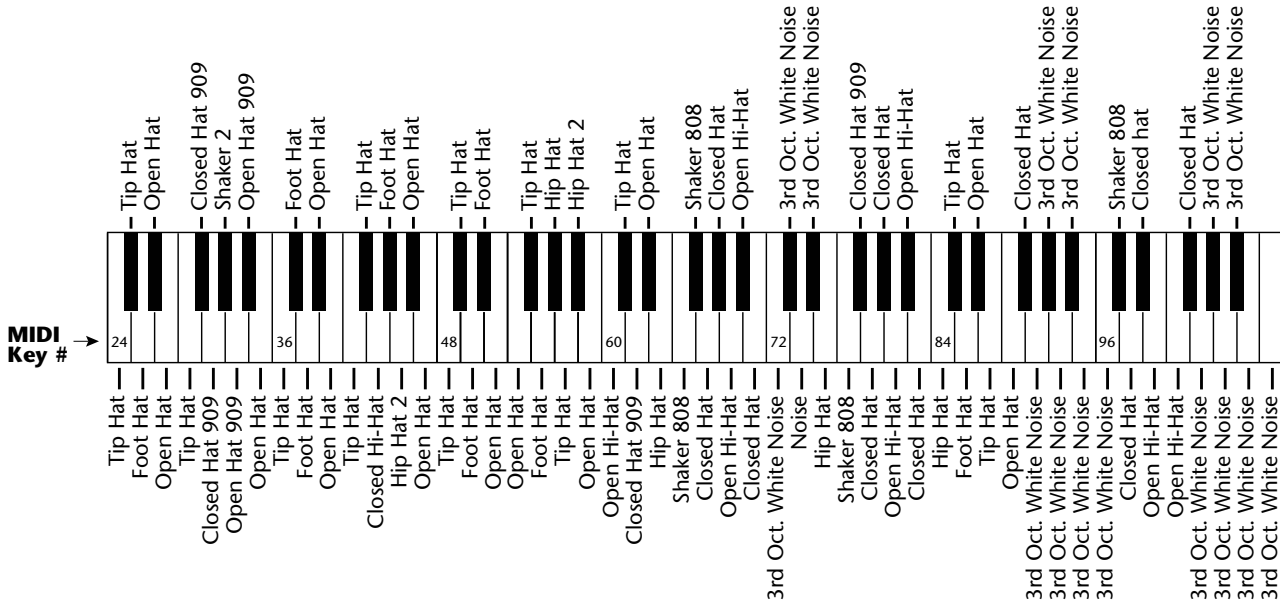

Hats & Noise
Instrument 237

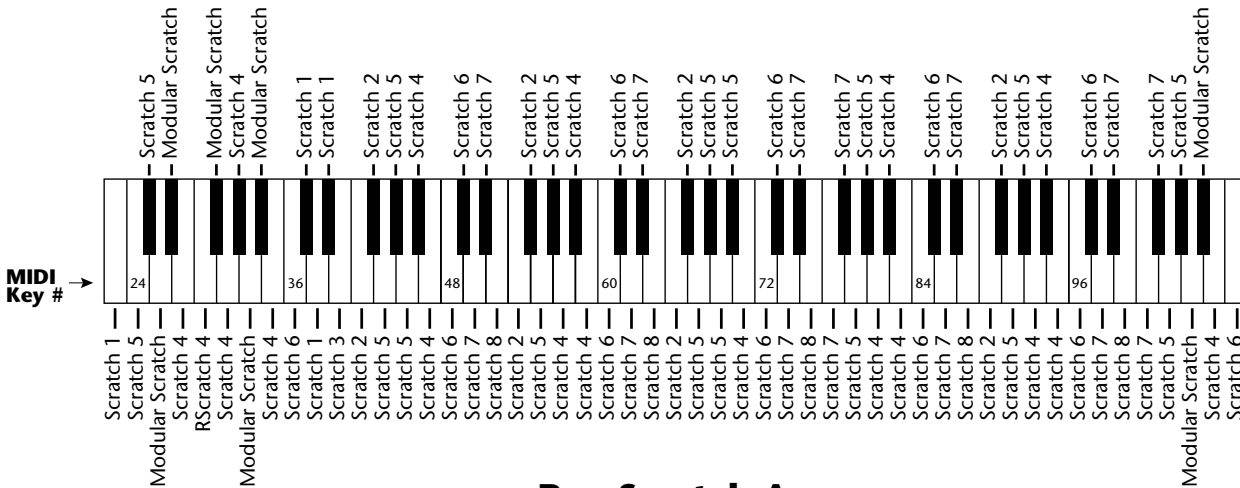

Rap Scratch A
Instrument 238

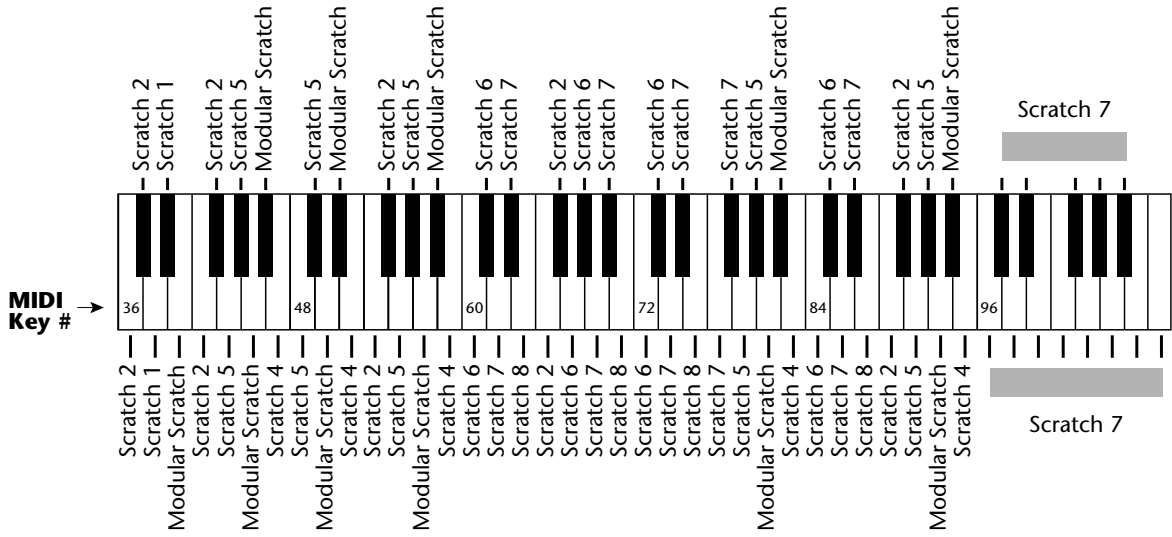

Rap Scratch B
Instrument 239

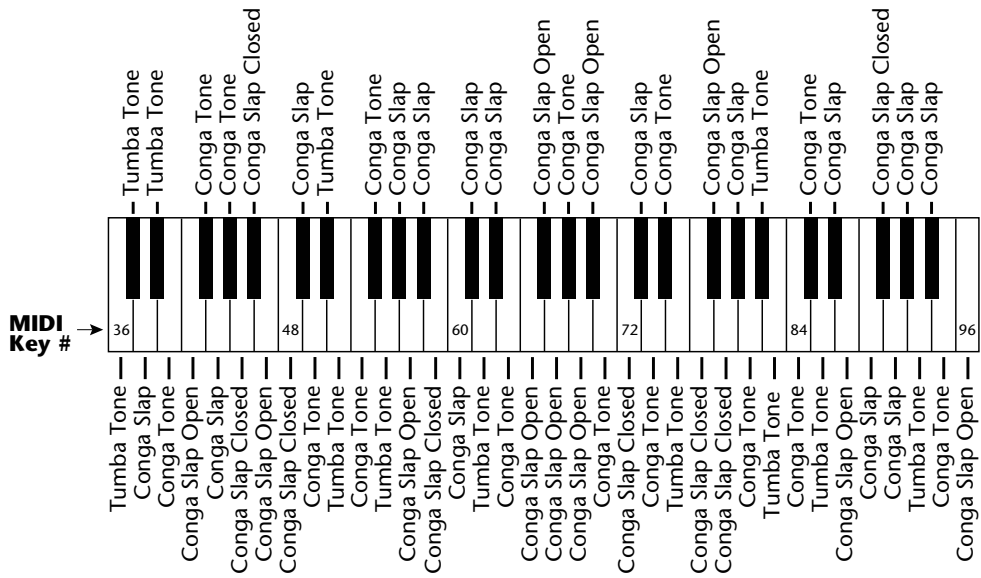

Conga Hits
Instrument 240

The Z-Plane filters are categorized into groups of: Flangers, Vowel Filters, Traditional Filters, Parametric Filters, Instrument Models, etc. A suffix of “4” or “.4” indicates filter is square, not cube and does not contain a Transform 2 axis.

FLANGERS

Members of this filter family contain a series of notches with various depths, widths and frequencies. The traditional flange effect is created by sweeping different frequency notches with a real time controller. Another application for flangers is enhanced dynamic expression at note-on by using velocity to modulate the frequencies of the notches and overall cut-off. These filters can simulate different pick positions on guitar strings and various locations of drum, mallet and cymbal strikes, etc.

F000 Null Filter

F001 Low Pass Flange .4

Morph: Starts with high end roll-off and deep, narrow notches at 500Hz, 100Hz, 200Hz, 400Hz and 800Hz and transforms into less deep, wider notches at 11799Hz, 13813Hz, 16169Hz, 17495Hz and 18928Hz with no roll-off.

Freq. Tracking: Moves the notches in the first frame of the Morph axis up two octaves. The second frame is completely flat. Tracks filter to keyboard frequencies with Note-on key assignment. Controls brightness.

Transform 2: Not used.

F002 Low Pass Flange Bk .4

A series of deep notches spaced at octave intervals morphing to less severe, more closely clustered high frequency notches. An additional lowpass filter is at the start of the Morph, opening as the maximum offset is reached.

Morph: Modulate this to create multi-flanging effects.

Freq. Tracking: Tracks flangers across the keyboard. Velocity controls brightness.

Transform 2: Not used.

F003 Flange 2 .4

This flanger has a series of 6 notches placed at octaves, not linearly. Frame 1 starts with notches at 50, 100, 200, 400, 800, and 1600Hz.

Morph: Moves all of the notches up in frequency to above 10kHz, with decreasing depth. This means that the deepest flanging effect is obtained in the first 1/3 to 1/2 of the morph parameter range. Note that deep notches can cut out the fundamental of a sound which might decrease the volume of the note.

Freq. Tracking: Moves the notches to 400, 800, 1600, 3200, 6400, 12800Hz, which allows key tracking to keep the “sweet spot” of the flanger centered over the harmonics of the note.

Transform 2: Not used.

F004 CubeFlanger

A flanging filter featuring deep notches tuned in octaves and a steep roll-off of high frequencies when all axes have no offset. High settings for Transform 2 can produce some rather metallic-sounding overtones. Apart from flanging effects, this filter can be used in much the same way as a standard resonant synth filter.

Morph: Tunes the filter notches.

Freq. Tracking: Controls lowpass filter cutoff point.

Transform 2: Increases resonance and introduces some peaks.

F005 Flange3.4

Notches are spaced at a ratio of 1.61 between notch frequencies, starting at 40Hz. This spacing means that notches will not fall on top of all of the harmonics of a sound at once. Instead, they should hit harmonics one at a time as they are swept in frequency. Traditional flangers have notches spaced linearly, not log spaced.

Morph: Moves all of the notches up above 10kHz, with the relative frequency spacing decreasing. The deepest flange effect will happen in the lower 1/3 to 1/5 of the morph parameter range.

Freq. Tracking: Sets the initial tuning of the notches, moving all of the notches up from 40Hz to 325Hz as the base frequency.

Transform 2: Not used.

F006 Flange 4.4

A highly resonant flanger /filter type. Sweeping the Morph axis produces dramatic effects. The Filter Frequency Track parameter can be used to tune the flanger; higher values produce more open sounds.

Morph: Increase to raise the cutoff frequency and vary the gain of the various peaks and notches.

Freq. Tracking: Tunes the filter.

Transform 2: Not used.

F007 Flange 5

A complex flange possessing some vocal-sounding characteristics. Sweeping along the Morph or Freq. Track axes produces flanger-like effects.

Morph: Tunes the notches.

Freq. Tracking: Spreads the notches.

Transform 2: Increase this to move the filter toward a more flat curve.

F008 Flange 6.4

Introduces both peaks and notches which start widely spaced and become more tightly distributed as Morph Offset reaches maximum. The center frequencies for the various filter bands move towards higher ranges as the Morph or Filter Freq. Track parameters are swept upward; the effect is not unlike a sweeping of multiple resonant band-pass filters.

F009 Flange 6R.4

This is a variation of filter 008, Flange 6.4. It is a bit more resonant-sounding, due in part to higher 'Q' settings. Sweeping the Morph axis can produce the syllable 'yi'.

Morph: Sweep filter frequency bands up and together when modulated in a positive direction.

Freq. Tracking: Sweep filter frequency bands up and together when modulated in a positive direction.

Transform 2: Not used.

F010 Flanger 7.4

A series of harmonically related notches is moved from the lower-midrange to the upper-midrange as this filter is moved along the Frequency Tracking axis. Morphing brings in the flanging effect

Morph: Use this to sweep the notches.

Freq. Tracking: Use this to tune the notches.

Transform 2: Not used.

F011 BriteFlnge.4

A series of notches, tuned in octaves, are swept upward and finally converge at 19.5kHz as this filter is pushed up along the Morph axis. A small bump at about 15kHz is introduced to maintain brightness when Morph is at completely offset.

Morph: Increasing this value sweeps the filter notches upward and together.

Freq. Tracking: Increasing this value raises the lowpass filter cutoff point.

Transform 2: Not used.

F012 Flng>Flng1

Morph: Sweeps from flange 1 to flange 2

Freq. Tracking: Provides key tracking to maintain spectrum.

Transform 2: Provides volume and brightness control with velocity and/or key position

Comments: Key tracking enhances the depth of the flange. Try adding velocity to Frequency Tracking for more "Fun".

F013 0>Flng2

Morph: Reveals flat to flange filter

Freq. Tracking: Provides key tracking to maintain spectrum

Transform 2: Adds volume, different flange

Comments: Nice for introducing a subtle flange to a pure sound. Velocity has a natural effect increasing flange depth, volume and brightness.

F014 Fln>Fln3b

Morph: Sweeps from flange 1 to 2

Freq. Tracking: Provides key tracking to enhance flanging

Transform 2: Increases depth of flange

Comments: A gentle sweeper.

F015: Fln>Fln4

Morph: Sweeps flange

Freq. Tracking: Provides key tracking to enhance flanging.

Transform 2: Reduces depth of flange effect with Morph offset, otherwise, increases flange depth.

F016 Fln>Fln5

Morph: Sweeps from flange 1 to 2

Freq. Tracking: Provides key tracking to enhance flanging.

Transform 2: Increases depth of flange, more bell-like.

Comments: Morphing sweeps gently, but Transform 2 adds more depth and introduces a bell-like quality to the flange.

F017 Fln>Fln6

Morph: Sweeps from flange 1 to 2.

Freq. Tracking: Provides key tracking to fix partials.

Transform 2: Provides more brightness and flange.

F018 Fln>FlnT

Morph: Sweeps between flat and flange.

Freq. Tracking: Provides key tracking to fix partials.

Transform 2: Provides more brightness and flange.

Comments: A gentle-touch flanger. Low Transform 2 gives a soft chorus on morphing. Higher Transform 2 gives exaggerated depth.

F019 Fln>FlnC

Morph: Sweeps from open to closed response with all other axes at 0.

Freq. Tracking: Controls brightness.

Transform 2: Adds extra flange.

F020 CO>FlnT

Morph: Sweeps from a reveal (almost flat) point to low pass peaks

Freq. Tracking: Raises frequency of peaks.

Transform 2: Increases depth of flange.

DIPHTHONGS

Implemented with parametric equalizer subsections, the resonances do not have the traditional overall lowpass effect that a true vocal resonance would have. Instead, they are placed at the same frequency as the resonances would be found in a true vowel, but the response at high frequencies is essentially flat to allow high frequencies of the samples to get through the filter.

The Morph axis controls movement between vowels. Key tracking is controlled by Frequency Tracking. Brightness and depth of effect is controlled by Transform 2. In certain filters, brightness is controlled by assigning velocity to Frequency Tracking. Each paravowel “A” contains peaks at 800, 1150, 2800, 3500 and 4950Hz. Each paravowel “E” contains peaks at 400, 1600, 2700, 3300 and 4900Hz. Each “O” has peaks at 450, 800, 2830, 3500 and 4950Hz. Each “U” has peaks at 325, 700, 2530, 3500 and 4950Hz.

F021 AEPaRLPVow

This paravowel has a low pass filter to provide additional roll off, when desired. Otherwise, it behaves as the other paravowels.

Morph: Controls movement between vowels. Try setting Transform 2 to 255 for additional brightness.

Freq. Tracking: Shifts all of the resonances up in frequency.

Transform 2: Controls volume, depth of effect.

F022 AEPaRVowel

Morph: Controls movement between vowels. Try setting Transform 2 to 255.

Freq. Tracking: Shifts all of the resonances up in frequency.

Transform 2: Controls the amplitude of all of the resonances, with 000 providing the lowest resonance amplitude, and 255 providing the highest resonance amplitude.

F023 AOLpPaRVow

This paravowel has a low pass filter to provide additional roll off, when desired. Otherwise, it behaves as the other paravowels.

Morph: Controls movement between vowels. Try setting Transform 2 to 255.

Freq. Tracking: Shifts all of the resonances up in frequency.

Transform 2: Controls the amplitude of all of the resonances.

F024 AOLpPaRVowel

Morph: Controls movement between vowels.

Freq. Tracking: Shifts all of the resonances up in frequency.

Transform 2: Controls the amplitude of all of the resonances.

F025 AUParaVow.4

Morph: Controls movement between vowels.

Freq. Tracking: Shifts all of the resonances up in frequency.

Transform 2: Controls the amplitude of all of the resonances.

F026 UOParaVow.4

Morph: Controls movement between vowels.

Freq. Tracking: Shifts all of the resonances up in frequency.

Transform 2: Controls the amplitude of all of the resonances.

F027 SftEOVowel4

Morph: Controls movement between vowels.

Freq. Tracking: Shifts all of the resonances up in frequency.

Transform 2: Controls the amplitude of all of the resonances.

F028 SoftEOAE

Morph: Controls movement between vowels.

Freq. Tracking: Shifts all of the resonances up in frequency.

Transform 2: Controls the amplitude of all of the resonances.

F029 Vocal Cube

Morph: Sweeps frequencies.

Freq. Tracking: Assign to velocity for brightness control.

Transform 2: Tunes filter.

F030 C1-6 Harms4

Morph: Sweeps between a notch at 190Hz to a series of closely spaced peaks from 120Hz to 640Hz

Freq. Tracking: Tracks filter with keyboard. Try assigning velocity to Frequency Tracking for brightness control.

Transform 2: Not used.

F031 Voce.4

Morph: Controls movement between “oo” and “ee”.

Freq. Tracking: Designed for velocity control of brightness. (Transforms to frequencies two octaves higher.)

Transform 2: Not used.

F032 ChoralComb4

Morph: Sweeps between different frequency notches tuned for vocal formants.

Freq. Tracking: Tracks filter with keyboard range.

Transform 2: Not used.

F033 Bassutoi.4

Morph: Controls movement between “yu” and “ee”.

Freq. Tracking: Tracks filter with keyboard range and controls brightness with velocity assigned.

Transform 2: Not used.

F034 Be Ye.4

Designed to say “Be Ye”.

Morph: Sweeps vocal formants.

Freq. Tracking: Tracks filter with keyboard range and controls brightness with velocity assigned.

Transform 2: Not used.

F035 Ee-Yi.4

Morph: Controls movement between vowels “e” and “i”.

Freq. Tracking: Tracks filter with keyboard range and controls brightness with velocity assigned.

Transform 2: Not used.

F036 li-Yi.4

Morph: Controls movement between vowels.

Freq. Tracking: Tracks filter with keyboard range and controls brightness with velocity assigned.

Transform 2: Not used.

F037 Uhrrrah.4

Morph: Roars like a lion.

Freq. Tracking: Tracks filter with keyboard range and controls brightness with velocity assigned.

Transform 2: Not used.

F038 YeahYeah.4

See “What Yeah” preset.

Morph: Moves between “ee” and “ya” sounds.

Freq. Tracking: Tracks filter with keyboard range and controls brightness when assigned to velocity.

Transform 2: Not used.

F039 Vow>Vow1

Morph: Sweeps between “ah” and “oh”.

Freq. Tracking: Provides key tracking to balance keyboard brightness.

Transform 2: Provides volume and brightness control with velocity and/or key position.

Comments: Transform 2 increases volume and depth of vowel effect.

F040 Vow>Vow2

Morph: Sweeps between “ee” and “oh”.

Freq. Tracking: Provides key tracking to fix partials.

Transform 2: Provides volume and brightness control with velocity and/or key position.

Comments: Morphing sweeps between vowels- slight “E” effect.

F041 YahYahs.4

Morph: Sweeps between “eeya” and “aa”.

Freq. Tracking: Introduces frequencies two octaves higher for key tracking and brightness control.

Transform 2: Not used.

F042 YoYo.4

Morph: Sweeps between “ee” and “oh” sounds.

Freq. Tracking: Introduces frequencies two octaves higher for key tracking and brightness control.

Transform 2: Not used.

F043 VowelSpace

Dr. William Martens developed this filter cube, which allows any vowel to be approximated with only two parameters.

Morph: Sweeps the first formant of the vowel from 150Hz up to 850Hz.

Freq. Tracking: Sweeps the second formant from 500Hz up to 2500Hz.

Transform 2: Changes the vowel “stress.” Low stress means that all of the vowel frequencies collapse to a relaxed “schwa” sound. Maximum Transform produces the maximum excursion (stress) for all of the vowel frequencies.

STANDARD

These filters are variations on traditional 2 and 4-pole filter models

F044 BrickWallLP.4

This filter features an extreme rolloff at the cutoff point, which moves from 100Hz to 3000Hz. Use this filter to produce low-resonance filter sweeps, or to selectively filter out high frequencies in the source sound.

Morph: Controls filter cutoff.

Freq. Tracking: Controls filter depth and provides gentler roll-off beginning ~3000Hz.

Transform 2: Not used.

F045 BrickWal LP2

Morph: Controls filter 'Q'.

Freq. Tracking: Controls filter cutoff.

Transform 2: Use to control filter depth.

F046 MdQ 2PoleLP

A single pole of this filter is swept from low to high as the filter is Morphed. This filter produces nice, not-too-resonant sweep effects.

Morph: Controls filter cutoff.

Freq. Tracking: Controls filter cutoff.

Transform 2: Controls resonance.

F047 HiQ 2PoleLP

A more resonant version of filter 046, again with a single frequency band being swept about according to Morph.

Morph: Controls filter cutoff.

Freq. Tracking: Controls filter cutoff.

Transform 2: Controls resonance.

F048 MdQ 4PoleLP

Similar to filters 046 and 047, in this filter two of the poles (tuned to the same frequency) are swept to create a steeper rolloff at the cutoff point, re-creating the classic 4-pole lowpass filter effect. This filter features medium resonance which can be accentuated via the Transform 2 offset.

Morph: Controls filter cutoff.

Freq. Tracking: Controls filter cutoff.

Transform 2: Controls resonance.

F049 HiQ 4PoleLP

Again, (as with filters 046-047), two poles tuned to the same frequency are swept to create a steep rolloff at the filter cutoff point. This filter features high 'Q', which can be controlled via Transform 2.

Morph: Controls filter cutoff.

Freq. Tracking: Controls filter cutoff.

Transform 2: Controls resonance.

F050 2poleLoQLP4

This is basically a 2-pole lowpass filter which can be swept from 60Hz to 19.5kHz. Modulating the Frequency Tracking parameter upward will increase filter resonance. A good choice for emulating certain kinds of analog filter effects.

Morph: Controls filter cutoff.

Freq. Tracking: Controls resonance.

Transform 2: Not used.

F051 4 PoleLoQ.4

A resonant low-pass filter emulation. Morphing creates the familiar filter sweep effect.

Morph: Controls filter cutoff.

Freq. Tracking: Controls filter resonance.

Transform 2: Not used.

F052 4PoleMidQ.4

A 4-filter version of the classic 4-pole resonant filter found in most analog synthesizers.

Morph: Controls filter cutoff.

Freq. Tracking: Controls resonance (“Q”).

Transform 2: Not used.

F053 2p>4p 0

Morph: Opens up the filter making it brighter.

Freq. Tracking: This adds a small amount of resonance (Q) to the filter.

Transform 2: Changes from a 4-pole filter (-24dB/oct.) to a 2-pole filter (-12dB/oct.).

Comments: This All Pole filter is modeled on traditional lowpass filter. It has a soft resonance boost.

F054 LowPassPlus

Morph: Sweeps from octave peaks starting at 220Hz to inharmonic, higher frequency peaks.

Freq. Tracking: Keyboard tracking.

Transform 2: Brightens the response.

F055 Low Past.4

Poles with fairly high ‘Q’ settings are grouped into the lower- to upper-midrange. Sweeping along the Morph or Frequency Tracking axes can produce some rather vocal-sounding effects.

Morph: Use to sweep the frequencies of the pole.

Freq. Tracking: Use to tune the filter.

Transform 2: Not used.

F056 APass.4

Simple lowpass filter with gentle rolloff above 200Hz; morphs to flat.

Morph: Gentle lowpass to flat response.

Freq. Tracking: Also moves the filter towards a flat response, allowing you to control the depth of filtering

Transform 2: Not used.

Comments: A good choice when more subtle filtering is desired.

F057 HPSweep.4

A highly resonant high-pass filter which generally rolls off frequencies steeply below ~2.5kHz. A low Morph Offset will create a relatively flat response (with a gentle cut to the lower frequencies), so the most subtle filtering is achieved with Morph Offset set to 000, and Frequency Tracking set to 255.

Morph: Positive values move the filter higher in frequency.

Freq. Tracking: Positive values move the filter toward a flatter curve.

Transform 2: Not used.

F058 HiSwept1.4

A highly resonant filter with 'Q' increasing as the Morph or Frequency Tracking parameters are swept upward. Increase the value for Frequency Tracking to accentuate this brightness and resonance.

Morph & Freq. Tracking: Control filter cutoff and resonance.

Transform 2: Not used.

F059 HghsSwpt2.4

A more open-sounding version of filter 058. Raises both the filter cutoff point and filter 'Q'.

Morph & Freq. Tracking: Raises both the filter cutoff point and filter 'Q'.

Transform 2: Not used.

F060 HighAccent.4

The center frequencies remain constant throughout all permutations of this filter along the Morph and Frequency Tracking axes; what changes are the 'Q' settings for the various poles and zeros. This allows you to accentuate various resonances, (generally in the upper frequency ranges), of the source sound by manipulating the Morph Offset point and the Frequency Tracking parameter.

Morph: Controls 'Q' of the various poles.

Freq. Tracking: Higher values produce brighter, thinner sounds.

Transform 2: Not used.

F061 HiPassSweep.4

A high-pass filter with the cutoff point moving from about 160Hz to upwards of 2.5kHz (with a sizable gain in resonance) as the filter is morphed upward.

Morph: Higher settings increase cutoff frequency and 'Q'.

Freq. Tracking: Controls filter depth.

Transform 2: Not used.

F062 Deep Combs

This filter can provide a tremendous variety of comb-filtering and filter sweep effects. Higher frequencies are sharply attenuated with Frequency Tracking and Transform 2 set to low values, so be sure at least one of these is either set in the mid- to high-range, or that a modulator is used to offset.

Morph: Positive modulation moves frequency notches towards lower values.

Freq. Tracking: Positive modulation moves frequency notches towards lower values.

Transform 2: Positive modulation moves frequency notches towards lower values.

F063 One Peak

Morph: Try setting Transform 2 to 255 for increased brightness over morph range. Sweeps from a slight peak at 220Hz and roll-off after 650Hz to a series of even peaks at 220,440, 880Hz, and a smaller odd series at 330, 555 and 770Hz.

Freq. Tracking: Tracks filter to keyboard.

Transform 2: Increases the effect of Morph and provides velocity sensing.

F064 More Peaks

Morph: Try setting Transform 2 to 255. Moves from a low cut-off flat frame to a series of peaks at 220, 440, 880, 330, 1000 and 2000Hz.

Freq. Tracking: Tracks keyboard.

Transform 2: Intensifies effect and controls volume.

F065 Rev Peaks

Morph: Try setting Transform 2 to 255. Moves from flat with a low-frequency cut-off to a series of peaks at 220, 440, 660, 880, 1100 and 1320.

Freq. Tracking: Tracks keyboard with notches three octaves higher.

Transform 2: Contains higher gain peaks at same frequencies as Morph axis for volume control and deeper effect.

F066 Notcher 2.4

Frames 1 and 3 contain multiple, unevenly spaced notches and peaks, while frames 2 and 4 are essentially flat. Modulating upward along the Morph axis, pushes the filter towards flat. Modulating Frequency Tracking upwards tends to give the source material a bit rounder, more 'open' sound.

Morph: Sweeping over a narrow range with a quick LFO produces some nice rotating speaker effects.

Freq. Tracking: Can be used to tune the filter.

Transform 2: Not used.

F067 Ntches2Oct4

This filter is composed of a series of notches, tuned in octaves.

Morph & Freq. Tracking: Moves notches lower in frequency.

Transform 2: Not used.

Comments: Maximum shift is two octaves along either axis, for a combined total of four octaves if both axes are modulated.

F068 Odd>+

Morph: Changes from odd to even harmonics.

Freq. Tracking: Provides key tracking to maintain spectrum.

Transform 2: Provides volume and brightness control.

Comments: Hints at odd harmonics which are then changed into a different shape depending on the position of Transform 2. (Transform 2 mostly respects natural changes in brightness, however.)

F069 VarSlope.4

A low-pass filter in which the rolloff above the cutoff point (400Hz) becomes steeper as the value for Morph Offset is increased.

Morph: Changes the slope of the rolloff.

Freq. Tracking: Moves the filter toward flat response.

Transform 2: Not used.

Comments: A good choice when more subtle filtering is desired.

EQUALIZATION FILTERS

Most of these filters are variations of traditional parametric EQ filters.

F070 BassEQ 1.4

Morph: Contains deep notch at 196Hz, morphing to a slight bump at 132Hz and a dip at 2600Hz.

Freq. Tracking: Frequency Tracking opens filter completely at maximum offset.

Transform 2: Not used.

F071 B BOOST.4

Morph: Boosts frequencies around 60Hz, sweeping to open response.

Freq. Tracking: Provides gentle rise at 320Hz and 5kHz.

Transform 2: Not used.

F072 BssBOOST2.4

Morph: Boosts frequencies around 60Hz, sweeping to open response.

Freq. Tracking: Introduces a dip at 320Hz and a peak at 2059Hz. With axes offset, a bump at 60Hz and 1200Hz is introduced.

Transform 2: Not used.

F073 BassDrumEQ

Morph: Adds low end boost.

Freq. Tracking: Tends to smooth out the filter.

Transform 2: This adds high end at the expense of low end.

Comments: This is an EQ filter designed for bass drums, based on a low pass EQ filter. The transforms tailor to different types of bass drums.

F074 Snare LPEQ2

Morph: Controls brightness.

Freq. Tracking: This moves the mid range bump down a bit.

Transform 2: This will smooth the boost (widens the “Q”).

Comments: This is an EQ filter designed for snares, based on a low pass EQ filter. There is a strong boost in the 320Hz to 640Hz range and some boost on the low end to give it some punch. The transforms tailor to different types of snares.

F075 HiHatLPEQ

Morph: Controls brightness.

Freq. Tracking: Tends to make the EQ more complex.

Transform 2: Tends to modify the low end.

Comments: This is an EQ filter designed for hi hats, based on a low pass EQ filter. There is a strong boost in the 5kHz to 18kHz range and some cut on the low end. The transforms tailor to different types of hi-hats.

COMPLEX FILTERS

Many of these filters have never existed for musical applications before!

F076 HP LP PZ

Morph: Sets how open or closed the filter is.

Freq. Tracking: Sets the transition from high pass to low pass.

Transform 2: This sets the sharpness of the cut off.

Comments: This Pole/ Zero filter models both low pass and high pass filters.

F077 PZ Notch

Morph: Sets the notch's center frequency.

Freq. Tracking: This deepens the notch (more cut).

Transform 2: This makes the notch wider (widens the “Q”).

Comments: This Pole/ Zero filter is a notch that ranges from 80Hz to 10kHz.

F078 Band-aid

Morph: Sets the amount of cut on the high and low frequencies.

Freq. Tracking: This widens the band.

Transform 2: This softens the amount of cut on the high end.

Comments: This Pole/ Zero filter is a band pass that cuts both the high and low end of the sample.

F079 LowQHiQ

Morph: Controls brightness.

Freq. Tracking: Changes from a 4-pole filter (-24dB/oct.) to a 2-pole filter (-12dB/oct.)

Transform 2: This adds resonance (“Q”) to the filter.

Comments: This All Pole filter is modeled on traditional low pass filter types. It can emulate most familiar analog sounds.

F080 Wah4Vib.4

Morph: Sweeps from slight rise above 1200Hz to a peak at 590Hz with roll-off after. Sounds more mellow and rounded as offset is increased.

Freq. Tracking: Tracks keyboard.

Transform 2: Not used.

F081 WaWa

Multiple resonant peaks flatten, then invert to become notches as the value for Morph Offset or Frequency Tracking is increased. Increasing the value for Transform 2 can have the effect of sweeping the peaks lower in frequency, inverting the peaks, or both, depending on the settings for Morph Offset and Frequency Tracking.

Morph & Freq. Tracking: Controls polarity of filter gain.

Transform 2: Tunes filter and controls polarity of gain.

F082 BrassRez.4

Compelling trumpet mute effect.

Morph: Try assigning Control A or Velocity to Morph as a note-on controller. Increasing Morph Offset reveals less muted, more open response. Reverse filter for opposite response.

Freq. Tracking: Modulates between a similarly shaped second set of resonances for additional Note-on control.

Transform 2: Not used.

F083 Clr>Oboe

Morph: Sweeps from Clarinet to Oboe

Freq. Tracking: Provides key tracking to fix partials.

Transform 2: Provides volume and brightness control with velocity and/or key position.

Comments: Strong morphing effect with this filter. Transform 2 takes care of velocity expressivity.

F084 O>Muter

Morph: Introduces “Mute”.

Freq. Tracking: Provides key tracking to fix partials.

Transform 2: Selects “Mute” variety.

F085 PZ Syn Horn

Morph: Controls brightness.

Freq. Tracking: This moves the harmonic modifiers higher in frequency.

Transform 2: This makes a modest change in brightness (fine tuning).

Comments: This filter models the harmonic content of a synth horn, thus will lend a synth horn sound to other samples.

F086 HP Brass

Generally, each frame in this filter cube provides either a steep rolloff of low frequencies or a sharp boost of high frequencies, with one axis arriving at flat response. Note that with Transform 2 set to 255, the polarity of the sweep along the Morph axis is reversed. This filter can be a good choice when you need a sharp accentuation of high-frequency material.

Morph: Sweeps the highpass filter, with direction dependent on setting of Transform 2.

Freq. Tracking: Higher values produce thinner, brighter sounds.

Transform 2: Sweeps the highpass filter, with direction dependent on setting of Morph Offset.

F087 BrassyBlast

This filter provides several responses similar to that of a lowpass filter, but with the addition of a gentle bump in the midrange to upper-midrange.

Morph: Use to sweep the filter.

Freq. Tracking: Adds a resonant bump at about 200Hz, which flattens out as the value is moved upward.

Transform 2: Works similarly to Frequency Tracking, but adds a gentle bump at about 8kHz as the offset is increased.

Comments: A very smooth-sounding filter, great for brass-type filter sweep effects.

F088 BrassSwell

Similar to a lowpass filter, but multiple resonant peaks give this one a bit of a vocal, phase-shifter-like quality.

Morph: Use to sweep the filter.

Freq. Tracking: Tunes the filter.

Transform 2: Higher values add midrange “beef” and resonance.

F089 BrsSwell2.4

An emulation of a lowpass filter with low resonance designed for brass-type filter sweeps.

Morph: Moves the cutoff frequency higher, and adds a gentle bump in the upper-midrange.

Freq. Tracking: Adds a bit of resonance at the cutoff point, which becomes flatter as the filter is morphed upward.

Transform 2: Not used.

F090 LoVelTrum

A series of tightly spaced peaks is swept upward by each of the filter transforms, with the brightest sounds obtained at maximum settings for Morph Offset, Frequency Tracking, and Transform 2. In addition, Transform 2 increases the resonance.

Morph and Freq. Tracking: Sweeps the peaks.

Transform 2: Tunes the peaks and increases resonance.

F091 Chiffin.4

Morph: Sweeps between low frequency notches.

Freq. Tracking: Allows the notches to track the keyboard.

Transform 2: Not used.

Comments: Use with noise to create a chiff sound on wind instruments.

F092 ShakuFilter

Morph: Sweeps between peaks at 400Hz, 1600Hz, 2700Hz and 3150Hz with roll-off after 30kHz to a mostly flat response with a slight bump at 1900Hz.

Freq. Tracking: Keyboard tracking.

Transform 2: Controls tone and depth.

F093 Cym

Morph: Sweeps from peaks at 100Hz, 300Hz, 400Hz, 600Hz, 900Hz and 1500Hz to peaks at 200Hz, 600Hz, 800Hz, etc.

Freq. Tracking: Keyboard tracking.

Transform 2: Deepens the effect.

Comments: Designed to make interesting cymbal sounds. Both Morph and Frequency Tracking manipulate frequency sweeps.

F094 VelMarim

Morph: Sweeps frequencies of small, closely-spaced peaks.

Freq. Tracking: Keyboard tracking.

Transform 2: Deepens the effect.

Comments: Designed to make dynamic marimba sounds using mallet and plate sounds.

F095 EZ Vibez.4

Like 098-“Easy Rhodes”, this is essentially a 2-pole low-pass filter, sweeping from a gentle roll-off at 65Hz to reveal a wide open response.

Morph: Sweeps from lowpass to wide open response.

Freq. Tracking: Keyboard tracking.

Transform 2: Not used.

F096 Piano 01

Designed to make possible a set of Piano presets that sound like they were recorded with the sustain pedal down.

F097 PianoFltr4

This filter functions much like a lowpass filter with a low ‘Q’ setting. Cutoff frequency is controlled along the Morph axis. Increasing the value for Frequency Tracking increases overall brightness. Although this filter is designed to work well for adding expressiveness to piano-type sounds, it can also be useful in many instances when a filter with a gentle slope is required.

Morph: Controls cutoff frequency.

Freq. Tracking: Controls cutoff frequency and brightness.

Transform 2: Not used.

F098 EZ Rhodex4

A lowpass filter, with cutoff frequency ranging from about 200Hz to about 5kHz along the Morph axis.

Morph: Sets cutoff frequency.

Freq. Tracking: Controls filter depth.

Transform 2: Not used.

F099 MoogVocodr4

Designed to simulate the classic vocoder filter response. Morph sweeps the frequencies. Frequency Tracking produces a more nasal and enclosed effect.

Morph: Sweeps frequency.

Freq. Tracking: Increases resonance.

Transform 2: Not used.

F100 MoogVocSwp

Similar to “MoogVocodr4”, but brighter. Can create variety of interesting responses by altering offsets of each axis, such as sweeping Morph with Frequency Tracking at maximum.

Morph: Sweeps frequency.

Freq. Tracking: Increases resonance.

Transform 2: Changes the effect of the Morph parameter.

F101 StrngThing4

A series of widely spaced notches produces this filter, which can sound somewhat like a phase shifter when Morphed - especially if the value for Frequency Tracking is set fairly high. With Morph Offset and Frequency Tracking set high, the curve is essentially flat, with a gentle bump approaching 20kHz, so this filter might be a good choice for adding a subtle sparkle to some sounds.

Morph: Controls cutoff frequency and depth of notches.

Freq. Tracking: Tunes the filter.

Transform 2: Not used.

F102 StrSweep.4

Set Frequency Tracking between the ranges of 200 and 255, and gently modulate the Morph Offset parameter in its upper ranges for an effect that will accentuate bowing sounds in string programs.

Morph: Positive modulation increases filter center frequencies and resonance.

Freq. Tracking: Positive modulation decreases resonance, increases brightness slightly.

Transform 2: Not used.

F103 BassXpress

This filter provides increased bass, and a sharp notch.

Morph: Controls the depth of the notch.

Freq. Tracking: Tunes the notch.

Transform 2: Controls the lowpass filter cutoff frequency.

F104 Qbase.4

Morph: Sweeps from a bright nasal response to accentuated low-frequency boost.

Freq. Tracking: Tracks filter with keyboard.

Transform 2: Not used.

F105 AcGtrRs.4

This filter is designed to emulate some of the resonant characteristics of an acoustic guitar body. With Morph Offset and Frequency Tracking set to 000, the body is extremely resonant, as if a large acoustic guitar were close-miked near the sound hole. Vary the value for Morph Offset to vary the 'mic position'. Route velocity to Freq. Tracking for controlling brightness and 'pick position'.

Morph: Controls filter formant notch depth and position.

Freq. Tracking: Frequency Tracking.

Transform 2: Not used.

F106 Tube Sust.4

Use this filter with broad-band waves to produce sounds characteristic of distorted guitars. The fullest sounds are achieved with Morph Offset set to 255, and Frequency Tracking set to 000

Morph: Increasing this increases bass and midrange.

Freq. Tracking: Controls the lower-midrange.

Transform 2: Not used.

F107 GtrSkwk

Morph: Plays the squeak.

Freq. Tracking: Provides key tracking to balance keyboard brightness.

Transform 2: Makes brighter, adds more volume and squeak.

Comments: Higher Transform 2 allows morphing to “string squeak”. Best used with Aux. Env or Function Generator to control this. Routing Velocity to Transform 2 will reduce squeak on low velocities.

F108 GuitXpress

Increasing the Morph Offset value places a notch in the frequency spectrum, the tuning of which can be controlled via the Frequency Tracking and Transform 2 parameters. In addition, increasing the value for Frequency Tracking and/or Transform 2 raises the cutoff point of the lowpass filter. This filter can be used to add a measure of expressiveness, particularly to acoustic instrument simulations. Try using velocity to control Transform 2 and key position to Frequency Tracking. For an additional measure of control, assign Control A (the mod wheel) to control Morph in the Note-on Control section.

Morph: Increases the depth of the filter notch.

Freq. Tracking: Tunes the notch and controls filter cutoff point.

Transform 2: Tunes the notch and controls filter cutoff point.

F109 FG MajTrans4

This filter features a series of peaks tuned to the intervals found in a major triad. Modulating the Morph Offset from 000 to 255 moves the ‘chord’ from first to second inversion; the Frequency Tracking parameter can be used to tune the chord over a range of several octaves. The effect is perhaps easiest to hear applied to one of the noise waves. It also works well with the RecrdScrch waves.

Morph: Moves the ‘chord’ of resonant peaks from first to second inversion.

Freq. Tracking: Tunes the chord.

Transform 2: Not used.

F110 Tam

Morph: Sweeps frequencies from low to high. Try routing velocity or mod wheel to Morph with offset at 255.

Freq. Tracking: Designed for velocity control of volume & brightness.

Transform 2: Controls brightness and depth.

Comments: Designed to make interesting, dynamic tambourine sounds.

F111 HOTwell.4

Morph: Sweeps frequency range.

Freq. Tracking: Determines degree of frequencies accentuated.

Transform 2: Not used.

Comments: Works well with bell-like sounds.

F112 Bell.Waha

Morph: Sweeps between flat and bell.

Freq. Tracking: Provides key tracking to fix partials.

Transform 2: More dissonance and effect.

Comments: Morphing can pull bell-like sounds out of any sample. Transform 2 adds more dissonance. This is best used with BellWahb which has a similar action but uses different dissonant partials.

113 Belwahb

Morph: Sweeps between flat and bell.

Freq. Tracking: Provides key tracking to fix partials.

Transform 2: Controls dissonance and depth of effect.

Comments: See BellWaha

F114 0>Bell-

Morph: Sweeps from flat to dissonance.

Freq. Tracking: Provides key tracking to fix dissonant partials.

Transform 2: Increases bell-like effect, makes brighter, louder.

Comments: To be used in conjunction with 0>Bell+. Morphing sweeps partials downwards just away from harmonic values causing bell-like effects.

F115 0>Bell+

Morph: Sweeps from flat to dissonance.

Freq. Tracking: Provides key tracking to fix dissonant partials.

Transform 2: Increases bell-like effect, makes the sound brighter and louder.

Comments: To be used in conjunction with 0>Bell-. Morphing sweeps partials to a different dissonance than with 0>Bell-.

F116 Bel>Crs>Bel

Morph: Sweeps from flat to dissonance.

Freq. Tracking: Provides key tracking to fix dissonant partials.

Transform 2: Increases bell-like effect. Makes the sound brighter and louder.

Comments: Low velocities on Transform 2 reveals a hint of bells when Morphing. Higher Transform 2 values create a more bell-like and dissonant sound.

F117 Chrs>Fng1

Morph: Sweeps to a flange effect.

Freq. Tracking: Provides key tracking to enhance flange effect.

Transform 2: Makes brighter, increases volume.

Comments: Degree of flanging effect depends on velocity.

F118 Chrs>Fng2

Morph: Sweeps to a flange effect.

Freq. Tracking: Provides key tracking to enhance flange effect.

Transform 2: Makes brighter, adds volume.

Comments: Velocity controls degree of flange effect.

F119 Ev/OdNtch.4

Morph: Sweeps from even notches at 200, 400, 800Hz, etc with an overall low frequency cut-off to notches at 300, 600, 1200, 2400Hz, etc. effecting a warm to bright transition.

Freq. Tracking: Provides key tracking.

Transform 2: Not used.

F120 Odd/EvnNtch

Morph: Provides subtle modulation between odd octave intervals starting at 75Hz and even octave intervals starting at 50Hz.

Freq. Tracking: Controls brightness.

Transform 2: Deepens the effect and adds volume.

F121 NotchPkSwp4

Morph: Sweeps from nasal to bright; vowel shifts from 'oh' to 'ee'.

Freq. Tracking: Controls brightness and tracks keyboard.

Transform 2: Not used.

F122 1.5/3KNBPR4

Morph: Morphs from thin and high to richer and deeper to a yet a different timbre resonance; adds energy.

Freq. Tracking: Frequency Tracking thickens the spectral plot.

Transform 2: Not used.

F123 Swingshift

Morph: Try setting Transform 2 to 255 for brighter morph. Modulates from low-frequency cut-off to series of peaks at 349Hz, 494Hz, 698Hz, 988Hz etc.

Freq. Tracking: Tracks filter with keyboard.

Transform 2: Adds depth, volume.

F124 500up.4

Poles and zeros alternate, spaced at 500Hz intervals. Increasing Morph Offset boosts the peaks slightly, and greatly deepens the notches, producing an effect similar to band-pass filtering. This effect is further accentuated by increasing the Frequency Tracking value, as well as tuning the entire filter higher.

Morph: Increases depth of notches.

Freq. Tracking: Tunes the filter.

Transform 2: Not used.

F125 C1Harmonic5oct.8R

Morph: Try setting Transform 2 to maximum. Controls resonance.

Freq. Tracking: Controls resonance.

Transform 2: Tunes the filter.

F126 Odd>Even

Morph: Changes from odds to even harmonics.

Freq. Tracking: Provides key tracking to maintain spectrum.

Transform 2: Controls brightness and volume.

Comments: Odd harmonics are replaced by evens. Can give an impression a raising one octave.

F127 0>Shp1

Morph: Changes from flat to shape.

Freq. Tracking: Provides key tracking to maintain spectrum.

Transform 2: Controls brightness and volume.

Comments: Imposes a vowel like shape on a pure sound. (Can be useful for morphing in and out using two samples.)

F128 0>Shp2

Morph: Changes from flat to shape.

Freq. Tracking: Provides key tracking to maintain spectrum.

Transform 2: Controls brightness and volume.

Comments: More vowel like changes than 0>Shape1.

F129 0>Shp3

Morph: Sweeps to shape.

Freq. Tracking: Provides key tracking to balance keyboard brightness.

Transform 2: Controls brightness and volume.

Comments: Morphing imposes a shape on the sound. Low velocity for mellow, high for bright.

F130 Shp>Shp1

Starts with peaks every half octave from 66Hz and morphs to peaks every octave beginning at 66Hz Effect is “ee” to “u” with Frequency Tracking fully offset. Transform 2 reveals a completely flat response with all axes offset.

F131 Lpeq Vel

Morph: Moves between different “softs” & “brights”.

Freq. Tracking: Provides key tracking to maintain spectrum.

Transform 2: Controls brightness and volume.

Comments: Position of the Morph determines the nature of the softness and brightness.

F132 CleanSweep4

A number of lowpass, highpass and bandpass type effects can be produced using this filter. It works particularly well on solo brass waves to produce a variety of mute effects.

Morph: Effects range from lowpass with low ‘Q’ to highpass with high ‘Q’.

Freq. Tracking: Increase for thinner, brighter and more resonant sounds.

Transform 2: Not used.

F133 PowerSweeps

Alternating resonant peaks and notches, spaced at approximately half-octave intervals can be used to produce a number of flanging and vocal effects. The direction of Morph depends on the Freq. Tracking setting.

Morph: Modulating this sweeps the peaks/notches up and/or down.

Freq. Tracking: Tunes the filter; determines polarity of Morph.

Transform 2: Can also be used to tune the filter.

F134 TSweep.4

A grouping of inharmonically related peaks gives this filter something of a metallic quality, although it can also produce voice-like sounds. Increasing Morph Offset increases overall filter resonance and raises the cutoff point of the lowpass filter. Frequency Tracking can be used to tune the filter.

Morph: Controls 'Q'; controls lowpass cutoff.

Freq. Tracking: Tunes the filter.

Transform 2: Not used.

F135 SweepHiQ1.4

Morph: Sweeps from peaks at 150Hz, 430Hz, 870Hz, 1500Hz, 3000Hz and 7000Hz to peaks an octave higher.

Freq. Tracking: Introduces high Q peaks at 1.2kHz and 3.4kHz to narrowly spaced peaks at 1500Hz to 15kHz.

Transform 2: Not used.

F136 V>FcQuad.4

Designed for velocity to control filter cut-off. Each frame has an octave higher cut-off than the one before it.

Morph: Moves from a bump at 320Hz then a brickwall cut-off up an octave.

Freq. Tracking: Tracks keyboard.

Transform 2: Not used.

F137 Nexus.4

Morph: Moves from a brickwall low pass to higher frequency, relaxed slope response.

Freq. Tracking: Frequency Tracking at maximum inverts effect of morph.

Transform 2: Not used.

Comments: Designed for Frequency Tracking to control brightness with velocity.

F138 Krators.4

Morph: Provides resonant peaks at low-frequencies, morphing from lower to higher frequency.

Freq. Tracking: Controls brightness.

Transform 2: Not used.

Comments: Designed to control brightness by assigning Velocity to Frequency Tracking.

••• A "brickwall" filter is one with an extremely steep slope.

F139 Harmonix.4

Morph: Morphs between complex responses sweeping to mid frequency resonances while leaving edges untouched.

Freq. Tracking: Controls brightness and tracks keyboard.

Transform 2: Not used.

F140 GreenWorld4

Morph: A mellow low-frequency sweeper designed for piano applications.

Freq. Tracking: Controls brightness and tracks keyboard.

Transform 2: Not used.

F141 Comb/Swap.4

Morph: Controls a series of notches moving from 160Hz to 10kHz.

Freq. Tracking: Controls brightness and tracks keyboard.

Transform 2: Not used.

F142 Comb/HP.4

Morph: Sweeps between a series of low frequency notches to a high pass response.

Freq. Tracking: Keyboard Tracking and brightness control.

Transform 2: Not used.

Comments: Control the brightness by assigning Velocity to Frequency Tracking.

F143 Swirly

Morph: Moves from series of notches to fewer notches.

Freq. Tracking: Tracks keyboard.

Transform 2: Alters timbre of effect and adds dynamics.

Comments: Try a Transform 2 setting of 255 for a brighter Morph.

F144 Cavatate.4

Emphasizes frequencies from 160Hz to 2kHz.

Morph: Morphs to a modified high pass response.

Freq. Tracking: Brightness control .

Transform 2: Not used.

F145 GentleRZ4

A series of unevenly spaced resonant peaks converge to a single peak as Morph Offset is increased. The Frequency Tracking offset provides a somewhat muted sound (with several gentle bumps in the mid-frequency range), moving toward a flat response. Sweeping this filter produces some very smooth wa-wa effects. Using this filter with the trumpet waves can produce sounds suggestive of French Horns.

Morph: Modulating this sweeps filter peaks.

Freq. Tracking: Use this to control filter depth and cutoff.

Transform 2: Not used.

F146 Bendup/Swap

This complex filter features several series of tuned resonant peaks and notches which can seem to bend up or down in pitch depending on the settings for the various Morph, Frequency Tracking, and

Transform 2 parameters.

Morph: Use to tune the filter.

Freq. Tracking: Low values make upward filter sweeps appear to bend pitch up. High values make pitch bend appear to go down.

Transform 2: Higher values make the filter sound more open.

F147 Bendup

This is similar to filter number 146, except that the bend is always in an upward direction (if the Morph axis is swept in a positive direction). Frequency Tracking can be used to tune the filter over a nearly 2-octave range. Transform 2 is used to set the cutoff point of the lowpass filter; higher values raise the cutoff point.

Morph: Sweeps harmonic peaks.

Freq. Tracking: Tunes the filter.

Transform 2: Increase for a brighter effect.

F148 SKWEEZIT

This filter features a complex series of peaks and notches. Varying the Morph parameter varies the 'Q' settings for most of the peaks and notches, while sweeping the frequency and Q of the first pole.

Morph: Sweeps one of the resonant peaks and varies 'Q'.

Freq. Tracking: Tunes the filter.

Transform 2: Controls resonance.

F149 Lo/High4

A scattering of poles and zeros with fairly high Q settings produces this very resonant filter. Sweeping the Morph axis produces quite pronounced wa-wa effects in which multiple resonances are clearly audible. Morph Offset and Frequency Tracking can be used to tune the filter, although with Morph Offset set to 255, the filter is essentially flat.

Morph: Positive values increase pole/zero frequencies and decrease 'Q', opening the filter entirely.

Freq. Tracking: Similar to the Morph axis, but a bit higher in pitch.

Transform 2: Not used.

F150 SbtileMvmnt4

Morphing this filter to reverse the polarity of a series of more-or-less evenly spaced peaks and notches produces an effect more subdued than some types of filter sweeps. Using velocity or a mod wheel (assigned through the Note-on Control section) to control the Morph parameter can be useful when developing responsive plucked-string instrument sounds, such as guitar.

Morph: Controls polarity of poles.

Freq. Tracking: Tunes the filter.

Transform 2: Not used.

F151 Buzzy Pad.4

This filter produces a bump at 65Hz and a rolloff above 250Hz at low Morph values. Increasing the Morph value pushes the bump up to about 2kHz, and the cutoff of the lowpass filter up to 20kHz. Increasing the value of Frequency Tracking sends the bump higher yet — up to about 8400Hz at maximum offset. The effect of sweeping the Morph axis is similar to that of a classic 2-pole lowpass filter with medium resonance.

Morph: Tunes the filter.

Freq. Tracking: Tunes the filter.

Transform 2: Not used.

F152 Bw5kHz+6.4

Lowpass cutoff is set to 400Hz with "0" Morph Offset. In addition, there is a 6 dB bump at 5kHz. The bandwidth of this "bump" is controlled by the Morph parameter. Sweeping the Morph Offset upwards moves the bandwidth setting from very narrow to very wide. Frequency Tracking moves the cutoff frequency of the lowpass filter up to a maximum of 20kHz. The range of effects available is from fairly dramatic to quite subtle.

Morph: Controls filter bandwidth.

Freq. Tracking: Controls filter cutoff.

Transform 2: Not used.

F153 Bw65Hz/2k.4

This filter is similar to filter 152, but in addition to sweeping the bandwidth of a single peak along the Morph and Frequency Tracking axes, the peak itself is swept. The range of the frequency sweep is one octave along either axis, although much greater ranges of change are achieved when both the Morph and Frequency Tracking axes are combined. Effects range from gentle, analog-style filter sweeps (with the Frequency Tracking parameter set low), to more 'digital' sounding effects in which high-pitched, whistling harmonics are produced.

Morph: Controls bandwidth and frequency.

Freq. Tracking: Tunes the filter.

Transform 2: Not used.

F154 Bb80Hzbw1.4

With a Morph Offset value of "0", the lowpass filter cutoff is set at 400Hz, and there is a wide-band bump at 80Hz. Morphing the filter increases the gain of this bump from 6 dB to 24 dB. Frequency Tracking increases the cutoff to 19.5kHz, and decreases the bandwidth of the 80Hz bump.

Morph: Controls bandwidth.

Freq. Tracking: Tunes the filter.

Transform 2: Not used.

F155 HighsTwist4

The frequencies of the poles and zeros in this filter remain constant as Morph or Freq. Tracking are modulated, but the 'Q' values are modulated in a variety of ways. The filter is closest to flat (with some emphasis in the high frequency range and a small bump at about 200Hz) when Morph Offset and Frequency Tracking are both set to 000. Modulating either or both of these parameters upward emphasizes more of the highs, with increased values for Frequency Tracking, rolling off the lows as well.

Morph: Controls filter 'Q'.

Freq. Tracking: Modulate upward for thinner, brighter sounds.

Transform 2: Not used.

F156 Cubix

Morphing this filter produces a lowpass filter sweep effect, while pushing the Frequency Tracking parameter in a positive direction moves the filter towards a more flat response, with a bit of subtle emphasis in the higher frequencies.

Morph: Produces low-pass filter effects.

Freq. Tracking: Use to control key tracking or to set overall filter depth.

Transform 2: Controls brightness.

F157 Intervallc4

This filter is similar to the 'Bendup/Swap' filter, but here the effect is even more pronounced. With Frequency Tracking set to 000, pushing the Morph Offset higher produces a downward sweep of a series of very resonant harmonics. Set Frequency Tracking to 255, however, and the sweep reverses. Other effects can be achieved by experimenting with the interaction between these two parameters. Because of its metallic overtones, this filter can make a good choice for simulating certain percussion instruments, such as steel drums and kalimbas.

Morph: Causes a downward sweep of harmonic intervals.

Freq. Tracking: Reverses Morph sweep.

Transform 2: Not used.

F158 EvenCuts4

This filter produces a series of notches in the frequency spectrum (based on the even harmonic series), which turn into small bumps when morphed.

Morph: Controls the depth of the notches/height of the bumps.

Freq. Tracking: Tunes the notches/bumps.

Transform 2: Not used.

F159 OddCuts.4

This filter produces a series of notches in the frequency spectrum (based on the odd harmonic series), which turn into small bumps when morphed.

Morph: Controls the depth of the notches/height of the bumps.

Freq. Tracking: Tunes the notches/bumps.

Transform 2: Not used.

F160 PWMtrans.4

This filter produces a series of harmonically related notches, which become peaks as the filter is morphed upward — the effect can be similar to pulse width modulation, depending on the source material. As Frequency Tracking is moved upward, the peaks/notches move toward the high end of the frequency range, and 'Q' is increased, producing more resonant sounds.

Morph: Controls depth of the peaks/notches.

Freq. Tracking: Tunes the filter and controls 'Q' amount.

Transform 2: Not used.

F161 HiEndQ.4

This filter behaves much like a resonant low-pass filter.

Morph: Sweep this for low-pass filter effects.

Freq. Tracking: Sets the initial cutoff point of the filter.

Transform 2: Not used.

F162 BroadRes.4

Sweeping filter for resonant effects. Can be used for a “waterdrop” effect on percussion.

Morph: Sweeps to a series of peaks and notches. Notches: 80Hz, 160Hz, 320Hz. Peaks: 2kHz, 6kHz, 10kHz.

Freq. Tracking: Turns peaks into notches.

Transform 2: Not used.

F163 RubberHose4

This filter introduces a series of peaks spaced at octave intervals, in the range of 95Hz to 1.5kHz, and a single notch at 47Hz. Increasing the Morph Offset further raises the peaks and lowers the notch.

Morph: Use to control the depth of the peaks/notch.

Freq. Tracking: Higher values attenuate the effect of the filter.

Transform 2: Not used.

F164 HeeghCube

This filter produces a very subtle series of peaks above 4kHz. Morphing increases the gain and bandwidth of the peaks, slightly, and Frequency Tracking can be used to subtly raise the frequency of the peaks. Increasing the value for Transform 2 increases the gain of the peaks without affecting bandwidth.

Morph: Controls gain and bandwidth of peaks.

Freq. Tracking: Tunes the filter.

Transform 2: Controls gain of peaks.

F165 NoizCube

This filter introduces some subtle peaks into the high frequency range, along with a single peak which can be swept.

Morph: Sweeps a single frequency.

Freq. Tracking: Determines range of sweep.

Transform 2: Tunes the sweep, bandwidth, and ‘Q’.

F166 VelctyTilt

This filter can function as a sweepable, subtle low-pass filter.

Morph & Freq. Tracking: Control filter cutoff.

Transform 2: Controls filter resonance.

F167 SynthWow4

An emulation of a resonant low-pass filter. Both Morph Offset and Frequency Tracking control cutoff frequency; the brightest sounds are obtained with both these parameters set to 255.

Morph & Freq. Tracking: Control filter cutoff.

Transform 2: Not used.

F168 CntrySweep4

Multiple peaks are swept in a variety of directions, imparting a phase-shifter-like, almost vocal quality when this filter is morphed.

Morph: Set this higher to move widely spaced peaks closer together.

Freq. Tracking: Set this higher to move low-frequency peaks towards the higher ranges.

Transform 2: Not used.

F169 Diffuser4

Morphing this filter upward sweeps a resonant peak up in frequency and increases low frequency content. The Frequency Tracking parameter can be used to tune the peak.

Morph: Use to tune the resonant peak and control low-frequency content.

Freq. Tracking: Use to ‘tune’ the resonant peak and control low-frequency content.

Transform 2: Not used.

F170 MdlySweep4

Morphing this filter upward sweeps several resonant peaks up in frequency. The Frequency Tracking parameter can be used to tune the peaks.

Morph & Freq. Tracking: Tune the resonant peaks.

Transform 2: Not used.

F171 StrongShimr

This filter produces several deep notches in the frequency spectrum, which can be tuned or swept according to the settings and modulators for the Morph Offset, Frequency Tracking, and Transform 2 parameters.

Morph: Raising this value lowers the frequency of the notches, producing thinner sounds.

Freq. Tracking: Raising this value lowers the frequency of the notches, producing thinner sounds.

Transform 2: Raising this value raises the frequency of the notches, producing fatter sounds.

F172 Acc.Vel-1

Morph: Fixes soft “Start-point”.

Freq. Tracking: Provides key tracking to balance keyboard brightness.

Transform 2: Controls brightness and volume.

Comments: Velocity cube. Use Morph to establish soft start point.

F173 Acc.Vel-2

Variation of “Acc.Vel-1”, except somewhat brighter on bottom and mellower on top.

F174 Vel2-Wind

Morph: Fixes soft “Start-point”.

Freq. Tracking: Provides key tracking to balance keyboard brightness.

Transform 2: Controls brightness and volume.

Comments: Velocity cube. Use morph to establish soft start point. Good for wind instruments as more morph gives a “hollower” soft sound.

F175 Harmo

Morph: Changes from “peaky” lowpass response to smooth lowpass.

Freq. Tracking: Provides key tracking to balance keyboard brightness.

Transform 2: Controls volume, brightness and dissonance.

Comments: Cube construction - Use the Aux. Envelope to provide attack transient which then fades off to rear frames.

F176 Start>EndA

Morph: Complex peak at 80Hz to a very gentle lowpass response.

Freq. Tracking: Provides key tracking to balance keyboard brightness.

Transform 2: Brighter, more volume, more harmonics.

Comments: **Cube construction** - Use the Aux. Envelope to provide attack transient which then fades off to rear frames. Softer version than “HarmoEP”. Volume changes for sensitivity are maintained in the cube.

F177 Start>EndB

Morph: Flat response to gentle lowpass.

Freq. Tracking: Key tracking to balance keyboard brightness.

Transform 2: Controls volume, brightness and harmonic content.

Comments: Same model as Start>EndA but more bright and dissonant.

F178 MovingPick1

Morph: Tight<>Hollow

Freq. Tracking: Provides key tracking to balance keyboard brightness.

Transform 2: Controls brightness and volume.

Comments: Uses Morph to simulate acoustic versus electric type response to velocity: plucking closer or further from the bridge of a guitar for example.

F179 MovingPick2

A variation on “MovingPick1” to simulate different pick positions, for example. Morph moves closer to neck, further from bridge.

F180 Mph+Trns1

Morph: Makes vowel like changes.

Freq. Tracking: Provides key tracking to enhance vowel.

Transform 2: Controls vowels, brightness, volume.

Comments: Uses Morph to sweep from one vowel to another. Transform 2 takes care of velocity expression.

F181 O>Odds

Morph: Sweeps from flat to odds only.

Freq. Tracking: Provides key tracking to fix partials.

Transform 2: Controls brightness and volume.

Comments: Strong odds only spectrum with morphing. Transform 2 takes care of brightness.

F182 Comb Voices

Center frequencies of the poles and zeros in this filter can move in opposite directions as the filter is modulated along any of its axes, producing an amazing variety of possible curves. Sweeping the Morph axis produces some lovely phase-shifter/flanger-type effects, especially with the value for Transform 2 set fairly high.

Morph: Use this to animate the comb-filtering effect.

Freq. Tracking: Generally, this can be used to tune the filter.

Transform 2: Moves the filter toward more open sounds.

F183 Odd-Ev Hrm

A series of peaks and notches based on the odd and even harmonic series. Sweeping the Morph axis produces some lovely comb filtering effects, which can be either subtle or dramatic depending on other settings (especially that of Transform 2).

Morph: Use this to sweep the peaks/notches.

Freq. Tracking: Tunes the filter.

Transform 2: Tunes the filter and controls resonance.

F184 OddHrm+rez

This filter cube, based on the odd harmonic series, provides a number of comb-filtering effects. Use the Morph Offset to control filter ‘Q’, and Frequency Tracking and Transform 2 to tune the filter.

Morph: Increasing this parameter pushes the filter towards a flat curve.

Freq. Tracking: Tunes the filter.

Transform 2: Tunes the filter. Higher values add a high-frequency bump.

F185 EvnHrm+rez

This filter cube is nearly identical to the 'OddHrm+rez' filter, but it's based on the even harmonic series. The overall effect is quite similar, though somewhat less 'hollow' sound at certain settings.

Morph: Increasing this parameter pushes the filter towards a flat curve and reduced "Q".

Freq. Tracking: Tunes the filter.

Transform 2: Tunes the filter. Higher values add a high-frequency bump.

F186 MellowPeaks

This filter provides two or three mildly resonant poles which can be swept through the frequency spectrum in a number of ways, depending on the settings for the various parameters. With lower settings for Frequency Tracking, the filter takes on a distinctly vocal quality on most source material.

Morph: Positive values generally move the poles upward in frequency.

Freq. Tracking: Positive values generally move the poles upward in frequency.

Transform 2: Positive values generally move the poles upward in frequency.

F187 AHmBnd.4

The Morph Offset can be swept to sweep a cluster of resonant peaks, producing a pitch-bend effect. The effect is generally most pronounced with Frequency Tracking set to a fairly low value.

Morph: Sweeping produces 'pitch-bend' effect.

Freq. Tracking: Tunes the filter.

Transform 2: Not used.

F188 Vintage

Features an accentuated low end, and a series of notches which can be swept via morphing. The most dramatic resonant sweeps are produced with Frequency Tracking set to minimum and Transform 2 set to maximum, producing the classic analog filter sweep sound.

Morph: Use to sweep the filter.

Freq. Tracking: Tunes the filter.

Transform 2: Controls filter resonance.

F189 MildQPole

Morph: Sweeps between a shallow roll-off low-pass to almost flat response.

Freq. Tracking: Tracks keyboard.

Transform 2: At maximum, inverts morph effect.

F190 Bonk>CO

A series of highly resonant peaks alternating with notches are spaced at intervals of about an octave. The Morph Offset parameter is used to control 'Q' — modulating the Morph Offset upward causes the curve to flatten out. Frequency Tracking can be used to tune the peaks/notches; higher values move the peaks/notches into higher frequency ranges. Transform 2 also tunes the filter, but higher values cause the notches to move down in frequency, slightly. The overall effect of the filter can be very vocal, depending on the source material.

Morph: Controls resonance.

Freq. Tracking: Tunes the filter.

Transform 2: Subtly tunes the filter.

F191 Speaker

Groups of unevenly spaced bumps and dips in the frequency spectrum are used to simulate a number of speaker cabinet responses. Use Morph Offset, Frequency Tracking, and Transform 2 to vary the tuning and depth of the bumps and dips to simulate different speaker cabinet types.

All Axes: Vary center frequency and amount of boost/cut for the various filter bands.

F192 Expander

Frequency Tracking and Transform 2 provide a range of fairly broad-band boosts and cuts at various frequencies, with higher values generally providing thinner, brighter sounds. These can be used to add a measure of expressiveness to the source material — route 'Key' to control Frequency Tracking, for example, and 'Vel' to control Transform 2. Increasing the value for Morph Offset has the effect of flattening the curve, providing you with a filter depth control.

Morph: Use to control filter depth.

Freq. Tracking: Higher values produce thinner, brighter sounds.

Transform 2: Higher values produce thinner, brighter sounds.

F193 Separator

This filter features three inharmonically related resonant peaks, which can be swept via the Morph parameter, producing a metallic set of overtones. Applied to the noise waves, this can sound like whistling wind; applied to pitch sounds, it can produce anything from hollow, metallic resonances to accentuated high-frequency attack transients.

Morph: Use to sweep the resonant peaks.

Freq. Tracking: Tunes the filter.

Transform 2: Controls filter resonance.

F194 MildPolSwap

Basically, a variable cut-off low pass filter.

Morph: Tunes the filter.

Freq. Tracking: Tunes the filter.

Transform 2: Adds extra brightness to high morph.

DISTORTIONS

Jump Back! The Filter Level is useful to control the distortion filters.

F195 PoleCross.4

Crossing poles produces certain “hot” or “sweet” spots where frequencies correlate.

Morph: Crosses filter “poles” to create hot (distortion) or sweet spots.

Freq. Tracking: Adds extra bite to Morph.

Transform 2: Not used.

F196 ApDistB6.4

Reducing the Filter Level parameter in the preset will not only reduce the volume level, it will also reduce the amount of distortion effect. Therefore, routing velocity, mod wheel, pressure, pedal, etc to Filter Level controls the distortion’s depth as well as volume.

F197 TubeJam.4

All rules are broken here. Peaks are intentionally clipped, yet output volume is within tolerance....barely! Only the morph axis is active.

Freq. Tracking: Not used.

Transform 2: Not used.

This listing represents the actual order of the ROM samples in memory. This information may be useful when adjusting the Loop Offset parameters in the preset menu. When the loop size reaches the end of memory, it jumps back to the start.

- Start -	<i>Conga Tone</i>	<i>Acoustic Guitar - B5</i>
<i>Big Brass - G1</i>	<i>Tumba Tone</i>	<i>Acoustic Guitar - E6</i>
<i>Big Brass - C6</i>	<i>Conga Slap Closed</i>	<i>Sax - G1</i>
<i>Kenong</i>	<i>Conga Slap Open</i>	<i>Sax - A1</i>
<i>Elec. Bass 1</i>	<i>Conga Slap</i>	<i>Sax - C2</i>
<i>Elec. Bass 2</i>	<i>Bass Drum</i>	<i>Sax - E2</i>
<i>Emu Bass - B2</i>	<i>Quake Bass - C2 loop</i>	<i>Sax - G2</i>
<i>Saint Moog</i>	<i>Bright Tip Hat</i>	<i>Sax - A2</i>
<i>Guitar</i>	<i>Foot Hat</i>	<i>Sax - C3</i>
<i>Moog - A1</i>	<i>Big Open Hat 2</i>	<i>Sax - D3</i>
<i>DX7 - D2</i>	<i>Noise Hat</i>	<i>Sax - F3</i>
<i>Killer 808</i>	<i>Super Bird Cymbal</i>	<i>Sax - A3</i>
<i>Snare Drum</i>	<i>Shamen Snare Drum 1</i>	<i>Sax - C4</i>
<i>Snare 2</i>	<i>Shamen Snare Drum 2</i>	<i>CZ Bass 1</i>
<i>Distorto-Kick</i>	<i>Shamen Snare Drum 3</i>	<i>CZ Bass 2</i>
<i>Beef Rap Kick</i>	<i>Electric Bass</i>	<i>ResonBass</i>
<i>Snap Snare</i>	<i>TR909 Dry Bass Drum 1</i>	<i>Silkworm - A3</i>
<i>Super High Hip Snare</i>	<i>TR909 Dry Closed Hat</i>	<i>Cluster</i>
<i>Bass Drum</i>	<i>TR909 Dry Open Hat</i>	<i>Towel Rack</i>
<i>Orchestral Wimp Snare</i>	<i>TR909 Dry Clap</i>	<i>Solder -Sucker</i>
<i>Crisp Snare</i>	<i>TR808 Dry Clap 2</i>	<i>Wood Rasp</i>
<i>Rim Shot</i>	<i>TR808 Dry Snare</i>	<i>Iron Rattle</i>
<i>Hip Hat</i>	<i>TR808 Dry Rim 1</i>	<i>Noise Burst</i>
<i>Hi-Hat</i>	<i>TR808 Dry Shaker</i>	<i>Vise-Grip</i>
<i>Ohh</i>	<i>Dancera</i>	<i>Metal String</i>
<i>Kickin' 808</i>	<i>Dancera Hi</i>	<i>Gutt Bass</i>
<i>TR808 Snare</i>	<i>TR707 Tambourine</i>	<i>Gutt Bass</i>
<i>Shaker</i>	<i>Big Brass - F2</i>	<i>Upright Bass</i>
<i>Closed Hi-Hat</i>	<i>Big Brass - D4</i>	<i>Fretless Bass</i>
<i>Open Hi-Hat</i>	<i>Spectrum Pad</i>	<i>Fretless Bass</i>
<i>Cowbell</i>	<i>Spectrum Pad</i>	<i>Fretless Bass</i>
<i>Hi-Hat</i>	<i>Jupiter 8</i>	<i>Quick Bass</i>
<i>Tambourine</i>	<i>Orchestral String 2</i>	<i>Quick Bass</i>
<i>Chik</i>	<i>Strings</i>	<i>Quick Bass</i>
<i>Wahmute</i>	<i>Strings</i>	<i>Cool Vibe</i>
<i>TR909 Dry Bass Drum</i>	<i>Syn String</i>	<i>Cool Vibe</i>
<i>Electroclave</i>	<i>Strings - F3</i>	<i>Bright Vibes</i>
<i>Kick1 909</i>	<i>Strings - C4</i>	<i>Bright Vibes</i>
<i>Snare1 909</i>	<i>Strings - F4</i>	<i>Vibe Stick</i>
<i>Rubber 909 Bass</i>	<i>Orchestral String 1</i>	<i>Crotales D5</i>
<i>Snare 3 909</i>	<i>Orchestral String 1</i>	<i>Peking</i>
<i>Power Ambient Kick</i>	<i>TR808 Kick 2</i>	<i>Iron Saron</i>
<i>Snare 2</i>	<i>Acoustic Guitar - E1</i>	<i>Iron Saron</i>
<i>Ware Snare 2</i>	<i>Acoustic Guitar - A2</i>	<i>Sheppard Tone</i>
<i>Bock Clave 3</i>	<i>Acoustic Guitar - D3</i>	<i>Icy Pad 1</i>
<i>Click 3</i>	<i>Acoustic Guitar - G4</i>	<i>Icy Pad 2</i>

LOOP OFFSET SAMPLE LOCATIONS

Bright Electric Piano 1	Straight Saw 1	Pulse 94% - C2
Bright Electric Piano 2	Straight Saw 2	Pulse 94% - F2
Bosendorfer - D1	Straight Saw 3	Pulse 94% - B2
Bosendorfer - F1	Straight Saw 4	Pulse 94% - E3
Bosendorfer - C2	Big Saw - High A	Pulse 94% - A3
Bosendorfer - F2	Highest Saw	Pulse 94% - D4
Bosendorfer - B2	Pulse 50% - C0	Pulse 94% - G4
Moog Wave 1	Pulse 50% - F0	Pulse 94% - C5
Moog Wave 2	Pulse 50% - A0	Pulse 94% - F5
Moog Wave 3	Pulse 50% - G1	Pulse 96% - F0
Resonate Bass	Pulse 50% - C2	Pulse 96% - A0
Bosendorfer - E3	Pulse 50% - F2	Pulse 96% - D1
Bass-O-Drop	Pulse 50% - B2	Pulse 96% - G1
Kickin' 808	Pulse 50% - E3	Pulse 96% - C2
Bosendorfer - G3	Pulse 50% - A3	Pulse 96% - F2
Bosendorfer - D4	Pulse 50% - D4	Pulse 96% - B2
Bosendorfer - G4	Pulse 50% - G4	Pulse 96% - E3
Bosendorfer - C5	Pulse 50% - C5	Pulse 96% - A3
Bosendorfer - F5	Pulse 50% - F5	Square Wave
Bosendorfer - A5	Pulse 75% - C0	Square Wave
Bosendorfer - D6	Pulse 75% - F0	Square Wave
Bosendorfer - F6	Pulse 75% - A0	Pulse 96% - D4
Fretless Bass	Pulse 75% - D1	Pulse 96% - G4
Rock Organ - A5	Pulse 75% - G1	Pulse 96% - C5
Electric Guitar - E1	Pulse 75% - C2	Pulse 96% - F5
Electric Guitar - D2	Pulse 75% - F2	Pulse 98% - C0
Electric Guitar - G2	Pulse 75% - B2	Pulse 98% - F0
Electric Guitar - B2	Pulse 75% - E3	Pulse 98% - A0
Electric Guitar - E3	Pulse 75% - A3	Pulse 98% - D1
Electric Guitar - A3	Pulse 75% - D4	Pulse 98% - G1
Electric Guitar - E1	Pulse 75% - G4	Pulse 98% - C2
Bass Harmonic - E1	Pulse 75% - C5	Pulse 98% - F2
Bass Harmonic - A2	Pulse 75% - F5	Pulse 98% - B2
Bass Harmonic - D3	Pulse 90% - C0	Pulse 98% - E3
Bass Harmonic - G4	Pulse 90% - F0	Pulse 98% - A3
Guitar Harmonic	Pulse 90% - A0	Pulse 98% - D4
Guitar Low E	Pulse 90% - D1	Pulse 98% - G4
Bridge Pickup - E	Pulse 90% - G1	Pulse 98% - C5
Bridge Sample - G	Pulse 90% - C2	Pulse 98% - F5
Bridge Sample - A	Pulse 90% - F2	Pulse 99% - C0
Bridge Sample - C	Pulse 90% - B2	Pulse 99% - F0
Bridge Sample - E	Pulse 90% - E3	Pulse 99% - A0
A-String Octave	Pulse 90% - A3	Pulse 99% - D1
D-String Octave	Pulse 90% - D4	Pulse 99% - G1
G-String	Pulse 90% - G4	Pulse 99% - C2
Fretless Bass	Pulse 90% - C5	Pulse 99% - F2
Open E String - Pickup	Pulse 90% - F5	Pulse 99% - B2
Low E String	Pulse 94% - C0	Pulse 99% - E3
Open A String - 2 Pickups	Pulse 94% - F0	Pulse 99% - A3
Low E String - Pickup	Pulse 94% - A0	Pulse 99% - D4
High & Low E String	Pulse 94% - D1	Pulse 99% - G4
Bridge - E2	Pulse 94% - G1	Pulse 99% - C5

Pulse 99% - F5	Violin Essence - C5	Moog Rectangle 5 -
Noise	Buzzoon - A3	C6
3rd Octave White Noise	Buzzoon - A6	Ring Mod Wave
Triangle - D4	Brassy Wave - A3	Ice Bell 1
Triangle - D5	Brassy Wave - A4	Ice Bell 2
Triangle - D7	Brassy Wave - A5	Ice Bell 3
Octave 1 Sine	Woofer Pulse	Bronze Age - E3
Octave 2 All	Reedy Buzz	Bronze Age - E6
Octave 3 All	Reedy Buzz 2	Iron Plate - D4
Octave 4 All	Mini Moog	Iron Plate - D6
Octave 5 All	Choir 1	Aluminum
Octave 6 All	Reedy Buzz 3	Lead Beam
Octave 7 All	Choir 2	Steel Extract - A4
Octave 3 Odd	Growl Wave 1	Steel Extract - A6
Octave 4 Odd	Growl Wave 1	Winter Glass 1
Octave 5 Odd	Growl Wave 1	Winter Glass 2
Octave 6 Odd	Harpsiwave - A2	Winter Glass 3
Octave 7 Odd	Harpsiwave - A4	Winter Glass 4
Odd 1	Fuzzy Gruzz - A2	SE Synthesis
Even 1	Fuzzy Gruzz - A4	Trumpet Wave 1
Octave1	Acoustic Guitar Wave	Trumpet Wave 1
B3 Wave 1	Power Fifths - A2	Trumpet Wave 1
B3 Wave 2	Power Fifths - G2	Trumpet Wave 1
B3 Wave 4	Power Fifths - C3	Trumpet Wave 1
B3 Wave 5	Power Fifths - F3	Trumpet Wave 2
B3 Wave 6	Power Fifths - A3	Trumpet Wave 2
Organ 1	Metal Whisper 1	Record Scratch 1
Organ 2	Hollow Whisper 1	Upright Bass 1
Color Organ	Metal Whisper 2	Upright Bass 2
Synth Cycle - C1	Hollow Whisper 2	Upright Bass 2
Synth Cycle - C2	Formant Axe	Minimoog Lead 1
Synth Cycle - C3	JX Sync 1	Minimoog Lead 2
Synth Cycle - C4	JX Sync 2	Minimoog Lead 3
Fundamental Gone 1	Lead Sweep	Rhodes 1
Fundamental Gone 2	Pulse Sweep 1	Rhodes 2
Bite Cycle	Pulse Sweep 2	Hollow Wash
Buzzy Cycle	Pulse Sweep 3	Cluster
Metalphone 1	E-mu Modular	Swirly
Metalphone 2	Moog Rectangle 1 - G3	Pink Noise
Metalphone 3	Moog Rectangle 1 - G5	Mellow Pad
Metalphone 4	Moog Rectangle 1 - C6	Strings
Duck Cycle 1	Moog Rectangle 2 - G3	Record Scratch 2
Duck Cycle 2	Moog Rectangle 2 - G5	Record Scratch 3
Duck Cycle 3	Moog Rectangle 2 - C6	Record Scratch 4
Wind Cycle 1	Moog Rectangle 3 - G3	Record Scratch 5
Wind Cycle 2	Moog Rectangle 3 - G5	Record Scratch 6
Wind Cycle 3	Moog Rectangle 3 - C6	Record Scratch 7
Wind Cycle 4	Moog Rectangle 4 - G3	Scratch 1
Organ Cycle 2	Moog Rectangle 4 - G5	Mechavox
Violin Essence - B2	Moog Rectangle 4 - C6	Filtered Saw
Violin Essence - A3	Moog Rectangle 5 - G3	Octave 5 All
Violin Essence - C4	Moog Rectangle 5 - G5	- End -

Linear

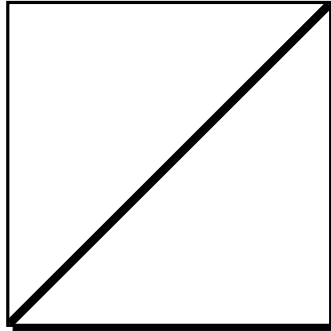

Exponential +1

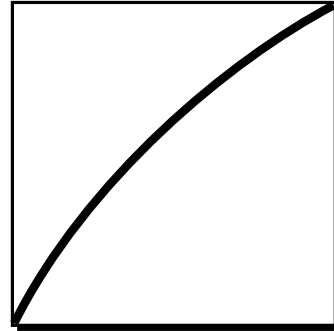

Exponential +2

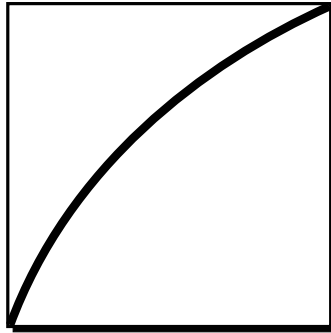

Exponential +3

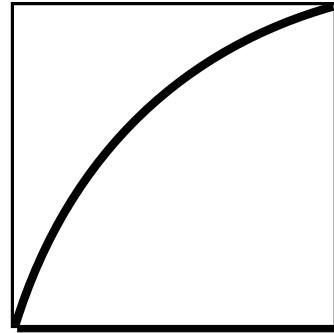

Exponential +4

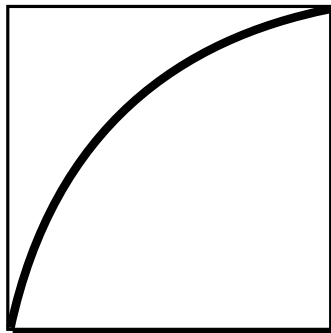

Exponential +5

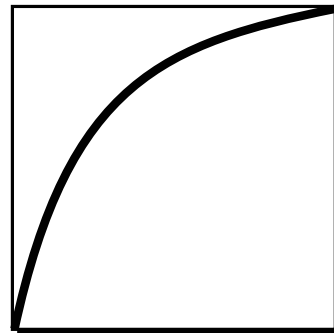

Exponential +6

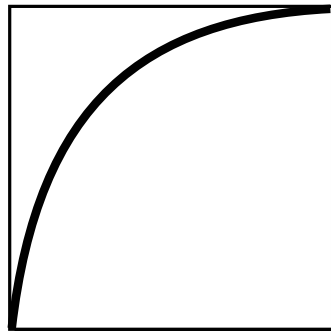

Exponential +7

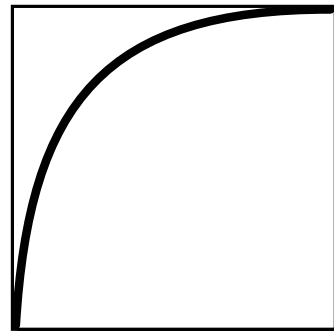

Circle 1.4

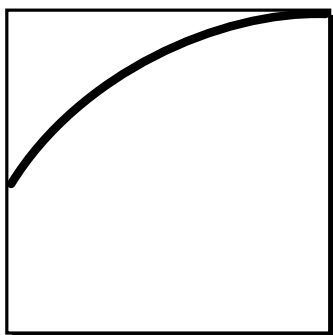

Circle 1.6

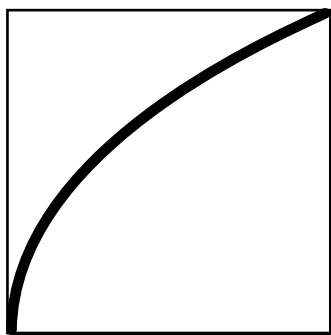

Circle 1.8

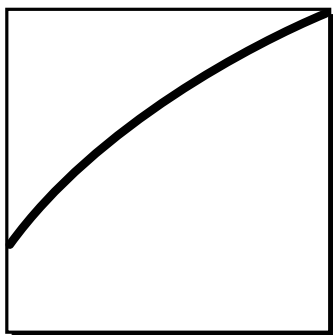

Circle 1.16

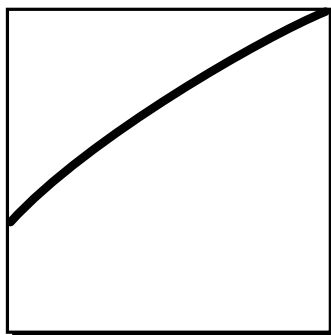

Squeeze

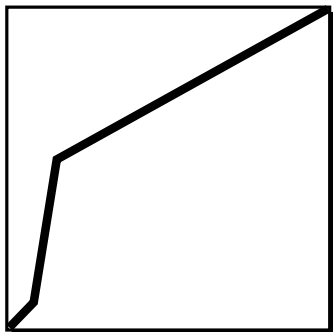

Fast Line 1

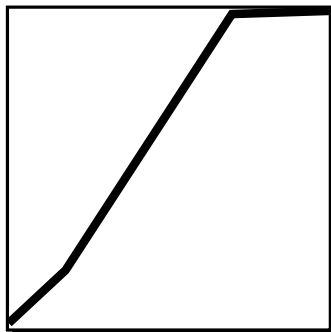

Fast Line 2

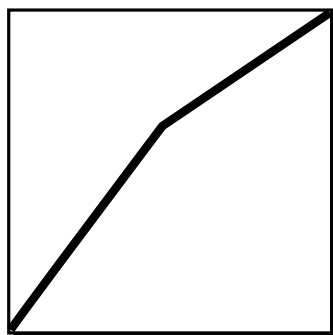

Fast Line 3

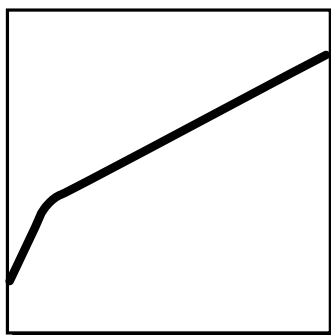

FUNCTION GENERATOR CURVES

Medium Line 1

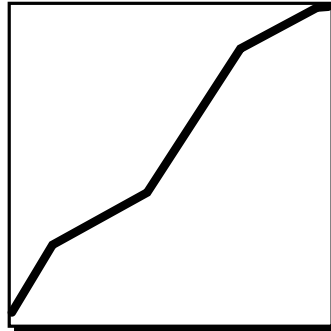

Medium Line 2

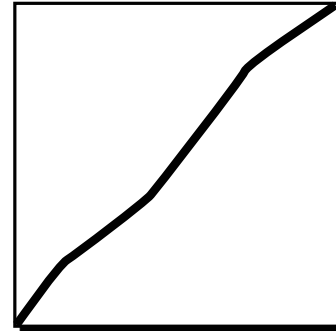

Slow Ramp 1

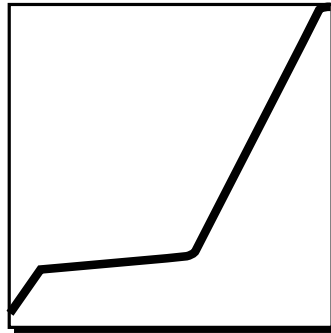

Slow Ramp 2

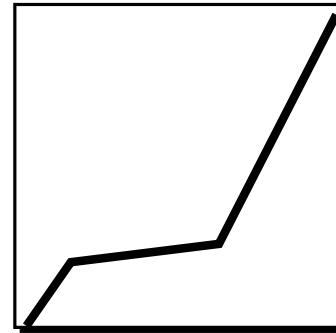

Bloom

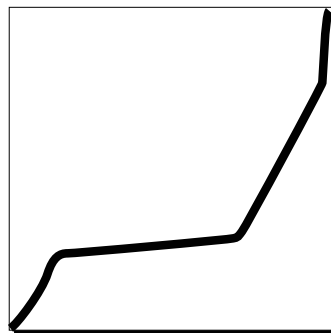

Bloom 2

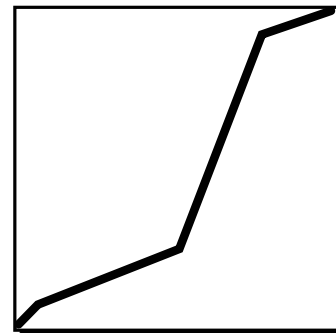

Circle 1.16 R

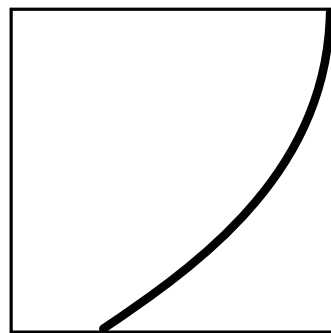

Circle 1.8 R

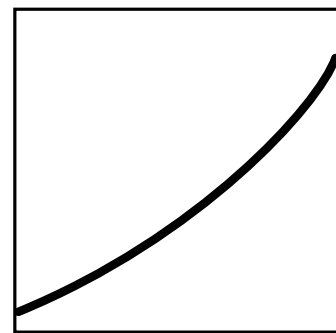

Circle 1.16 R

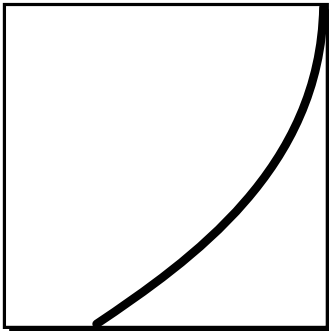

Circle 1.4 R

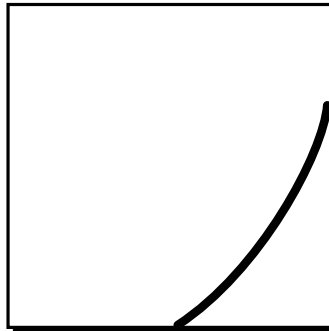

Slow Curve 1

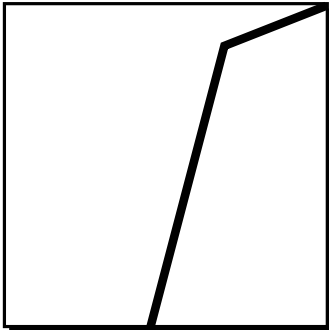

Slow Curve 2

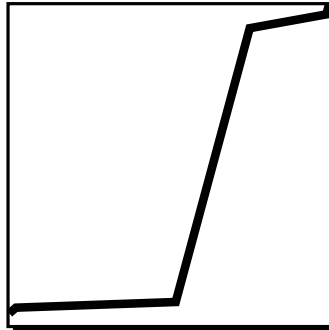

Delay DC

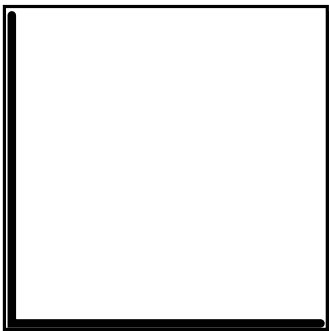

DC Delay

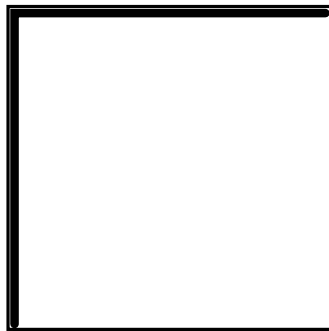

Curve 2x

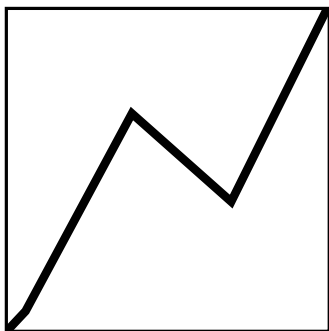

Curve 2x B

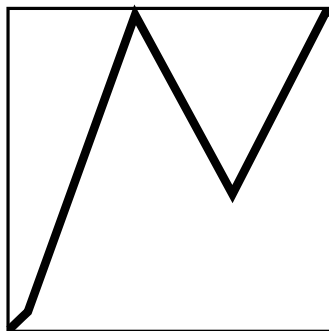

••• Delay DC waits for the specified time, then outputs the level.

••• DC Delay outputs the level, then waits for the specified time before moving on to the next segment.

These two shapes are useful for creating stepped mini-sequences.

Curve 2x C

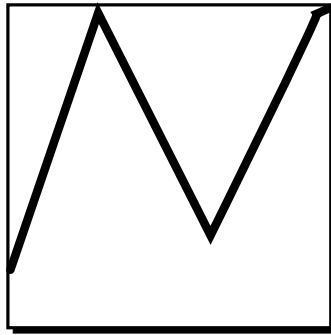

Ziz-Zag 1

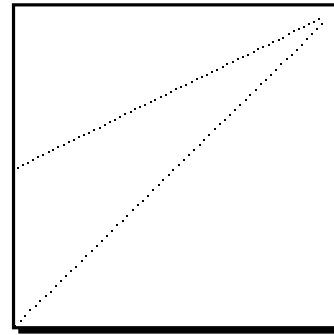

Ziz-Zag 2

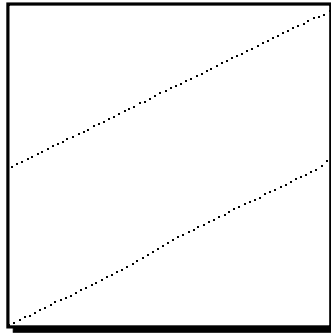

Ziz-Zag 3

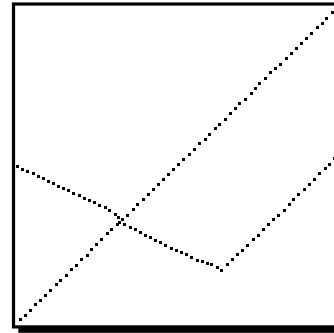

Chaos 03

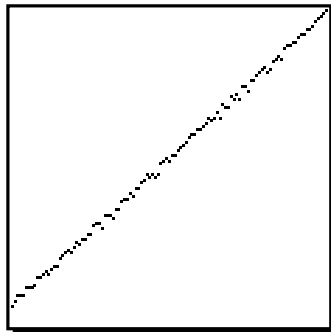

Chaos 06

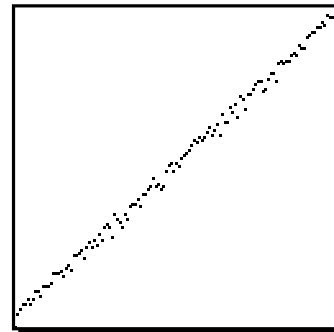

Chaos 12

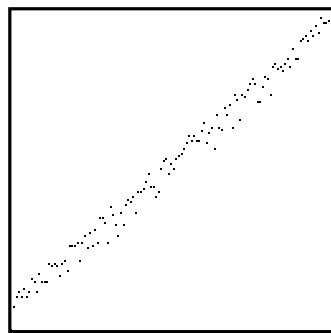

Chaos 16

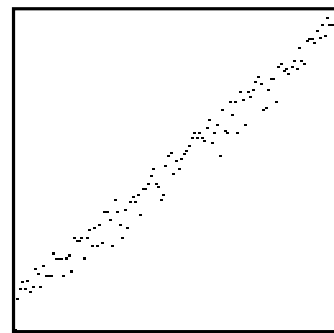

Chaos 25

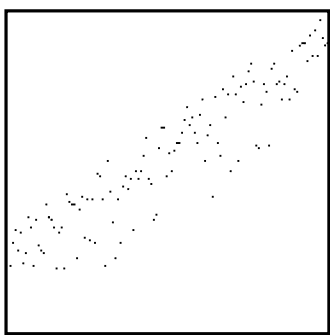

Chaos 33

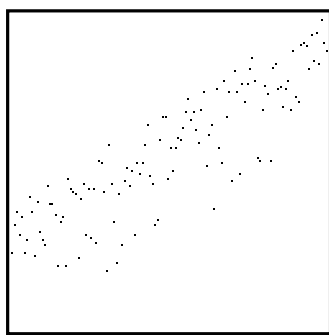

Chaos 37

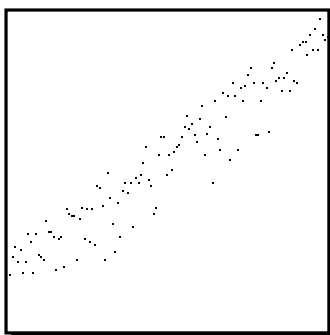

Chaos 50

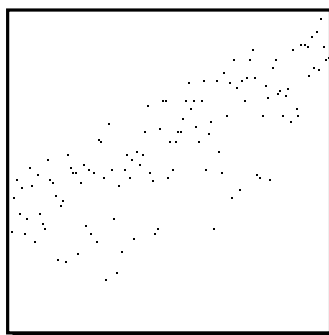

Chaos 66

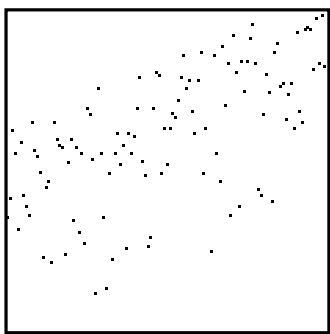

Chaos 75

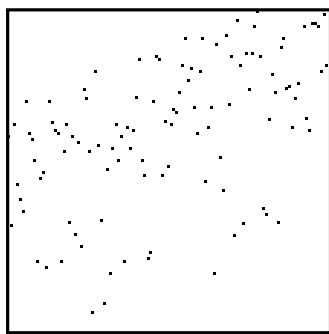

Chaos 95

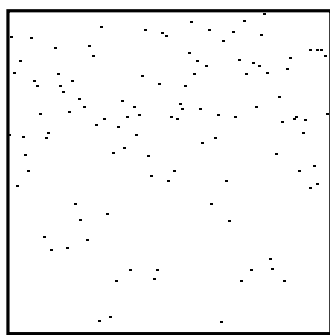

Chaos 99

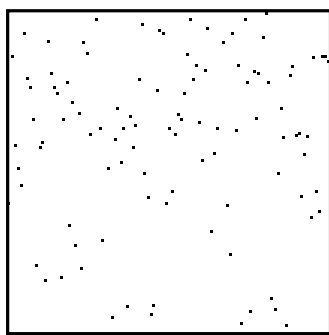

Linear Shuffle

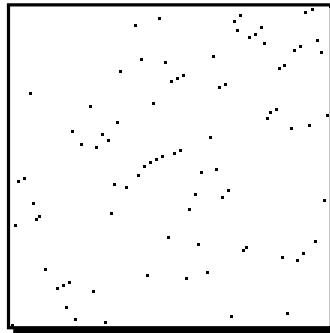

Linear Shuffle 2

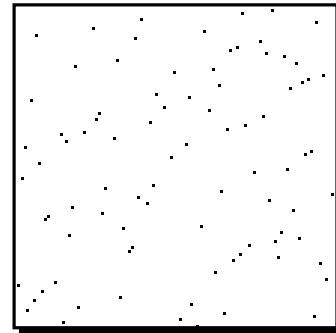

Random A

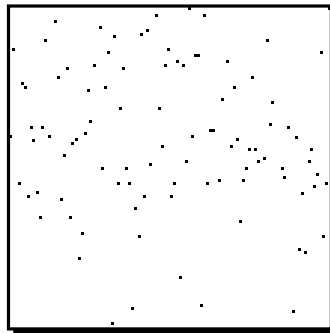

Random B

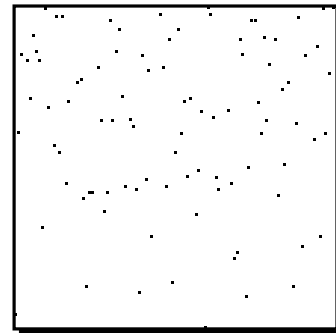

Random C

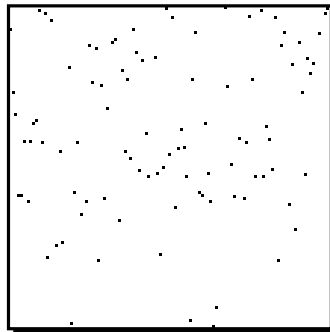

Random D

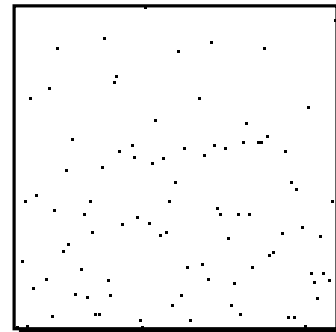

Random E

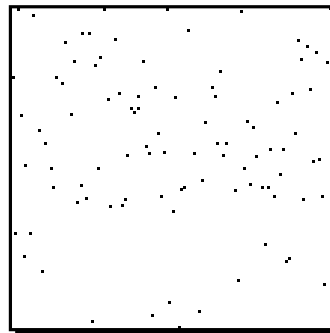

Random F

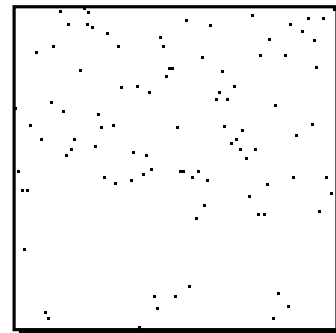

Random G

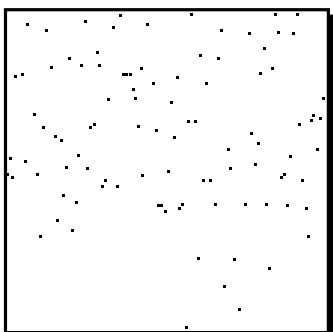

Random H

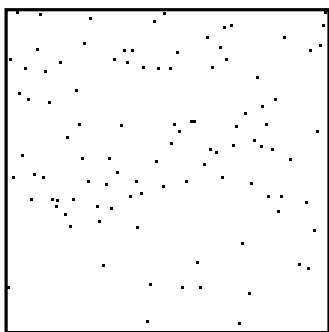

Random I

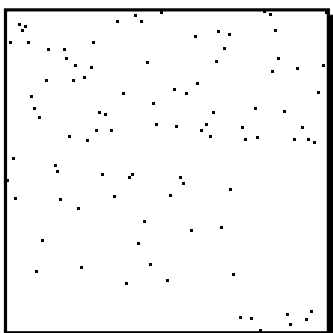

Random J

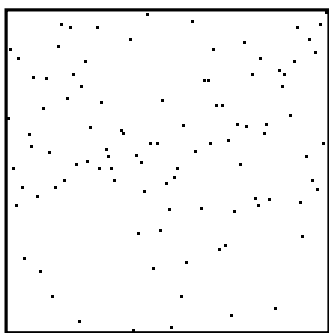

Random K

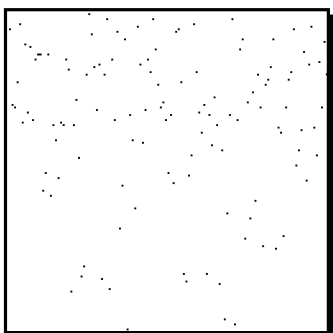

Random L

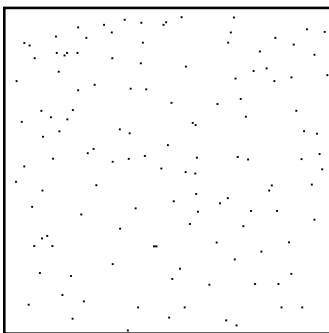

Random Z

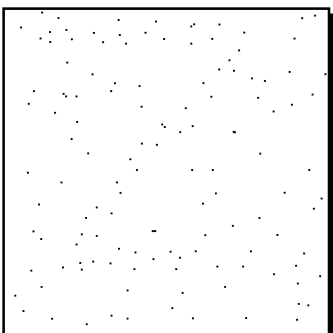

FUNCTION GENERATOR, LFO & ENVELOPE SPECIFICATIONS

DELAY TIMES	
Display	Time (secs)
1	.02
4	.10
8	.18
16	.38
32	.89
36	1.05
48	1.61
56	2.06
88	5.02
100	6.77
116	9.94
127	12.85

LFO RATES	
Display	Rate (Hz)
000	.052
5	.1
10	.6
15	.8
20	1.33
25	1.8
30	2.2
40	3.3
50	7
60	10
80	16
127	25

••• The Pitch Intervals can be used when modulating Pitch. All other attenuators should be set to +127. Multiple "patch cords" can be added For greater pitch intervals.

ENVELOPE RATES	
Display	Rate (secs)
4	.066
8	.090
16	.174
24	.246
32	.408
48	1.04
60	2.06
76	5.05
88	9.87
96	15.56
100	19.64
127	163.6

LFO PITCH INTERVALS	
Display	Semitone
32	1
65	2
98	3
127	4
127+36	5
127+69	6
127+101	<7

FUNCTION GEN. PITCH INTERVALS	
Display	Semitone
+16	1
+32	2
+49	3
+65	4
+81	5
+97	6
+113	7
+127	<8

MIDI IMPLEMENTATION CHART

Function...	Transmitted	Recognized	Remarks
Basic Channel	Default Changed	No No	1 1-16 Memorized
Mode	Default Messages	No	Mode 1, 3, 4 MONO, POLY OMNI, ON/OFF Memorized
Note Number	True Voice	No No	0-127 0-127
Velocity	Note ON Note OFF	No No	Yes v=1-127 No
After Touch	Keys Channels	No No	Yes Yes
Pitch Bender		No	Yes
Control Change		No	Yes 0-31 64-79
Bank Select		No	Yes
Program Change	True Number	No No	Yes 0-127 Yes 0-127
All Sound Off		No	Yes
All Notes Off		No	Yes
Reset All Controllers		No	Yes
System Exclusive		Yes	Yes
System Common	:Song Pos :Song Sel :Tune	No No No	No No No
System Real Time	:Clock :Commands	No No	No No
Aux Messages	:Local On/Off :Active Sense :Reset	No No No	No No No
<p>Notes: Pan 0=hard left 127=hard right Mode 1: OMNI ON, POLY Mode 2: OMNI ON, MONO Mode 3: OMNI OFF, POLY Mode 4: OMNI OFF, MONO</p>			

GENERAL INFORMATION FOR MORPHEUS SYSEX

- Product ID for Morpheus is **0C**.
- Device ID is [00-0F] (0-15 decimal).
- Parameter Number and Parameter Value are 2 bytes each.
- Since MIDI data bytes cannot be greater than [7F] (127 decimal), the data values are “nibble-ized” to a 14-bit signed 2's complement format.
- There is one edit buffer for the current preset (the preset shown in the display), one for the hyperpreset, and one for the midimap (the current midimap). Only one preset, hyper or midimap can be edited at a time via SysEx commands and changing the current preset, hyper or midimap erases the associated edit buffer.

RECEIVED CHANNEL COMMANDS

Channels number (n) = 0-15. Message bytes are represented in hex. All other numbers are decimal. Running Status is supported.

<i>Command</i>	<i>Message</i>	<i>Comments</i>
Note Off	8n kk vv	release velocity is ignored
Note On	9n kk vv	velocity 0 = note off
Key Aftertouch	An kk vv	kk = 0-127 vv = 0-127
Program Change	Cn vv	0-127
Channel Aftertouch	Dn vv	0-127
Pitch Bend	En ll mm	l = lsb, m = msb
Realtime Controller	Bn cc vv	cc = 00-31
Footswitch	Bn cc vv	cc = 64-79, vv ≥ 64 = on
Volume	Bn 07 vv	0-127
Pan	Bn 0A vv	0 = hard left, 127 = hard right
All Sound Off	Bn 78 00	turns all sound off
Reset All Controllers	Bn 79 00	ignored in omni mode
All Notes Off	Bn 7B 00	ignored in omni mode
Omni Mode Off*	Bn 7C 00	forces all notes & controls off
Omni Mode On*	Bn 7D 00	forces all notes & controls off
Mono Mode On (Poly Off)*	Bn 7E 00	forces all notes & controls off
Poly Mode On (Mono Off)*	Bn 7F 00	forces all notes & controls off
Bank Select	Bn 00 00 20 bb Cn pp	bb = bank # pp = program in bank

* Special Notes:

From Omni Mode ... Omni Off turns Poly On.

From Poly Mode Omni On turns Omni On; Mono On turns Mono On.

From Mono Mode ... Mono Off turns Poly On; Omni On turns Omni On.

From Multi Mode ... Omni On turns Omni On; Omni Off or Mono Off turns Poly On; Mono On turns Mono On.

All other changes have no effect.

●●● *Morpheus will receive Proteus presets (if enabled in the Master menu), but will fill in the extra parameters with default values and set instruments to "None".*

▼ *There is only one edit buffer each for the current preset, the current hyperpreset, and the current midimap.*

Only one preset, hyperpreset or midimap can be edited at a time via SysEx commands and changing the current preset, hyper or midimap erases the associated edit buffer.

MIDI SYSEX COMMANDS

For system exclusive commands, the following format is used:

F0	System Exclusive Status Byte
18	E-mu ID Byte
0C	Product ID Byte (<i>will also respond to ID 04 - Proteus</i>)
dd	Device ID Byte
cc	Command Byte
...	Data Bytes
F7	EOX

SysEx Editing

Preset and setup parameters may be edited individually using system exclusive commands. The preset being edited is the active preset (the preset on the basic or global channel and the one which is shown in the LCD). The value of a given parameter may be changed by sending a *parameter value* command. The value of a parameter may be read by sending a *parameter value request*, to which the machine will respond by sending back the parameter value. Please note that there is only one edit buffer

All SysEx bytes are displayed in Hex, unless specified otherwise. All comment numbers are displayed in decimal, unless specified otherwise.

Two MIDI bytes (lsb, msb) are required for each 14 bit data word. Bits 0-6 are sent first, followed by bits 7-13 in the next MIDI byte. All data words are signed 2's complement values with sign-extension out to the most significant bit (bit 13). This convention applies to all data words, regardless of the parameter's value range.

Preset data may also be transmitted or received in a single block (one complete preset) using system exclusive commands. A *preset data request* may be issued by a host computer, to which the machine will respond sending the data block for the requested preset. Conversely, the computer may send new preset data which will replace the specified preset currently in the machine. Additionally, a front panel command will transmit one or all user presets for backup onto an external sequencer. These presets may be restored by simply playing back the sequence into the machine.

Warning: When transferring preset banks and tuning table data back and forth from Morpheus to a computer, the data should be recorded as you would a regular sequence. Sending the data in one huge chunk will clog the input buffer on Morpheus unless a time period of approximately 100 mS is inserted between each preset. The SysEx Packet Delay feature in the Master menu can be used to slow down the data rate when the computer's input buffer is being clogged.

COMMAND SUMMARY

The following SysEx Command IDs are recognized by Morpheus.

Command Number	Function
00	Preset Request
01	Preset Data
02	Parameter Request
03	Parameter Data
04	Tune Table Request
05	Tune Table Data
06	Prog Map Request
07	Prog Map Data
08	Master Data Request
..	Unused
0A	Version Request
0B	Version Data
0C	Configuration Request
0D	Configuration Data
0E	Instrument List Request
0F	Instrument List Data
..	Unused
12	Preset List Request
13	Preset List Data
..	Unused
44	Hyperpreset Request
45	Hyperpreset Data
46	Midimap Request
47	Midimap Data
..	Unused
50	Hyperpreset List Req
51	Hyperpreset List Data
52	Midimap List Req
53	Midimap List Data
54	Effect List Req
55	Effect List Data
56	Filter List Req
57	Filter List Data

COMMAND DETAILS

All parameters are sent as 14-bit signed values, LSB-MSB. (See *discussion of number conversion*) numbers in the far left column are decimal offsets into the dumps. These numbers are added to the parm base offsets in order to do individual parameter editing. (See *PARAMETER editing cmds*) Data sent to a ROM card or a card that is protected is ignored. Requests for card data while card is not inserted will be ignored. Removing the card while a dump involving card data is in progress can cause unexpected results. (Generally, default data will be sent. no data corruption in the box should occur.)

PRESET REQUEST

Request preset. Uses preset index values (not the same as program numbers). Request for card presets will be ignored if card is not present. Preset numbers are: 0-127 RAM, 128-255 ROM, 256-319 CARD. Values 0x0400+ the bank number (0-2) represent request for banks. (Banks are blocks of 128 presets.)

F0	SysEx Status Byte
18	E-mu Mfg. ID
0C	Morpheus Product ID
dd	Device ID 0-15
00	Command ID
ll	lsb Preset Number
mm	msb Preset Number
F7	End of SysEx Status

PRESET DATA

Version 0x01 format is as follows:

F0	SysEx Status Byte
18	E-mu Mfg. ID
0C	Morpheus Product ID
dd	Device ID 0-15
01	Command ID - Preset Data
vv	Preset Data Version
ll	ls byte Preset Number
mm	ms byte Preset Number

Offset	Name	Range
0	Preset Name	12 chars, ASCII 32-127
12	Preset Low Key	0-127 MIDI key number
13	Preset Hi Key	0-127 MIDI key number
14	Bend Range	0-13, ± 0-12 semitones, 13 = Global
15	Velocity Curve	0-5, 0 = Off, 5 = Global
16	Keyboard Center	0-127 MIDI key number
17	Tune Table	0-5, Equal, Just C, Vallotti, 19-Tone, Gamelan, User
18	Mix Bus	0-3, Main, Sub1, FXA, FXB
19	Port Mode	0-5, Mono, Poly 1-5 keys
20	X-Fade Mode	0-2, Off, XFade, XSwitch
21	X-Fade Direction	0-1, Pri->Sec, Sec->Pri
22	X-Fade Balance	0-127
23	X-Fade Amount	0-255
24	X-Switch Pointt	0-127, MIDI key number or velocity
25	Note-on Source	See <i>PATCHCORDS SRC</i>
26	Note-on Dest.	See <i>PATCHCORDS SRC</i>
27	Note-on Amount	-128 to +127
	...	10 note-on cords (3 parms each)
55	Realtime Source	See <i>PATCHCORDS DEST</i>
56	Realtime Dest.	See <i>PATCHCORDS DEST</i>
57	Realtime Amount	-128 to +127
	...	10 realtime cords (3 parms each)
85	Foot Dest.	See <i>PATCHCORDS DEST</i>
	...	3 footswitch cords (1 parm each)
88	Ctrl. A Amount	-128 to +127
89	Ctrl B Amount	-128 to +127
90	Ctrl C Amount	-128 to +127
91	Ctrl D Amount	-128 to +127
92	Pressure Amount	-128 to +127
93	LFO Shape	0-4, Rand, Tri, Sine, Saw, Square
94	LFO Rate	0-127
95	LFO Delay	0-127
96	LFO Variation	0-127
97	LFO Amount	-128 to +127
	...	2 LFOs (5 parms each)
103	FG Amount	-128 to +127
104	FG Seg Level	See <i>FUNCGEN LEVELS</i>
105	FG Seg Time	0-4095 msec

▼ The parameter numbers shown at right must be added to the Preset Parameter Base value (8192 for preset parms) in order to access individual parameters.

••• The Parameters labeled with (L) are the primary layer. The secondary layer parameters begin at number 243.

Offset	Name	Range
106	FG Seg Shape	See <i>FUNCGEN SHAPES</i> chart
107	FG Seg CondJump	See <i>FUNCGEN CONDITIONS</i> chart
108	FG Seg CondVal	± 127
109	FG Seg DestSeg	0-7 segment number
	...	8 funcgen segments-6 parms each
	...	2 function generators-49 parms each
201	Aux Env Delay	0-127
202	Aux Env Attack	0-99 rate
203	Aux Env Hold	0-99 time
204	Aux Env Decay	0-99 rate
205	Aux Env Sustain	0-99 level
206	Aux Env Release	0-99 rate
207	Aux Env Amount	-128 to +127
208	Layer Instrument	See <i>INSTRUMENT NUMBERS</i>
209	(L) Low Key	0-127 MIDI key number
210	(L) Hi Key	0-127 MIDI key number
211	(L) Volume	0-127
212	(L) Pan	-7 to +7
213	(L) Course Tune	± 36 semitones
214	(L) Key Xpose	± 36 semitones
215	(L) Fine Tune	± 64 semitone/64
216	(L) AltEnv Enable	0-1, Off, On
217	(L) AltEnv Attack	0-99 rate
218	(L) AltEnv Hold	0-99 time
219	(L) AltEnv Decay	0-99 rate
220	(L) AltEnv Sustain	0-99 level
221	(L) AltEnv Release	0-99 rate
222	(L) Loop Enable	0-1, Off, On
223	(L) LoopStart MS	± 999 thousand samples
224	(L) LoopStart LS	± 999 samples
225	(L) LpSizeOff MS	± 999 thousand samples
226	(L) LpSizeOff LS	± 999 samples
227	(L) Sound Start	0-127
228	(L) Sound Delay	0-127
229	(L) Solo Mode	0-2, Off, Wind, Synth
230	(L) Solo Priority	0-4, Hi, Low, First, Last, Drum
231	(L) Portamento Rate	0-127, 0 = Off
232	(L) Pmento Shape	0-8, 0 = Linear, Expo1 - Expo8

Offset	Name	Range
233	(L) Double+Detune	0-15, 0 = Off
234	(L) Sound Reverse	0-1, Off, On
235	(L) Nontranspose	0-1, Off, On
236	(L) Filt Type	See <i>FILTER TYPES</i>
237	(L) Filt Reverse	0-1, Off, On
238	(L) Filt Level	0-255
239	(L) Filt Morph	0-255
240	(L) Filt FrqTrk	0-255
241	(L) Filt Trans2	0-255
242	(L) Unused	0
(L) = Layer	...	2 layers (35 parms each)
	cs	Checksum
F7		End of SysEx Status

••• The Parameters labeled with (L) are the primary layer. The secondary layer parameters begin at number 243.

• **Hyperpreset Request**

Request Hyper uses index values (not the same as program numbers). Request for RAM Card presets will be ignored if card is not present. Hyperpreset numbers are: 0-127 RAM, 128-255 CARD. Values 0x0400 + bank # represent request for banks. (Banks are blocks of 128 Hypers.)

F0	SysEx Status Byte
18	E-mu Mfg ID
0C	Morpheus Product ID
dd	Device ID 0-15
44	Command ID
ll	Hyperpreset Number ls byte
mm	Hyperpreset Number ms byte
F7	End of SysEx Status

• **Hyperpreset Data**

Version 0x01 format is as follows:

F0	SysEx Status Byte
18	E-mu Mfg. ID
0C	Morpheus Product ID
dd	Device ID 0-15
45	Command ID
vv	Data Version
ll	ls Byte Hyperpreset Number
mm	ms Byte Hyperpreset Number

••• The parameters labeled with (Z) equate to zone 1. Zones 2-16 begin at parameter number 72.

No.	Name	Range
0	Hyperpreset Name	12 chars, ASCII 32-127
12	Port Mode	0-5, Mono, Poly 1-5 keys
13	FG Seg Level	See <i>FUNCGEN LEVELS</i>
14	FG Seg Time	0-4095 msec
15	FG Seg Shape	See <i>FUNCGEN SHAPES</i>
16	FG Seg CondJump	See <i>FUNCGEN CONDITIONS</i>
17	FG Seg CondVal	± 127
18	FG Seg DestSeg	0-7 segment number
	...	8 funcgen segments (6 parms each)
61	Z Preset	-1 = None, 0-MAX PRESET
62	Z Volume	0-127
63	Z Pan	± 14
64	Z Low Key	0-127 MIDI key number
65	Z High Key	0-127 MIDI key number
66	Z Low Vel	0-127
67	Z High Vel	0-127
68	Z Vel Offset	± 126
69	Z Xpose	± 36 keys
70	Z Coarse Tune	± 36 semitones
71	Z Fine Tune	± 64 semitones/64
Z = zone	...	16 zones (11 parms each)
	cs	Checksum
	F7	End of SysEx Status

• **Midimap Request**

Request midimap. Request for card midimaps will be ignored if card is not present. Midimap numbers: 0-15 RAM, 16-31 CARD. Values 0x0400 + bank number (0-1) represent requests for banks. (Banks are blocks of 16 Midimaps) The scratch map is accessed by requesting MASTER settings or individual parameter requests.

F0	SysEx Status Byte
18	E-mu Mfg. ID
0C	Morpheus Product ID
dd	Device ID 0-15
46	Command ID
ml	ls byte Midimap Number
mb	ms byte Midimap Number
F7	End of SysEx Status

• *Midimap Data*

Version 01 of the midimap follows. If map is sent to current selected location, the scratch map will be loaded from the newly stored map.
Midimap numbers: 0-15 RAM, 16-31 CARD

F0	SysEx Status Byte
18	E-mu Mfg. ID
0C	Morpheus Product ID
dd	Device ID 0-15
47	Command ID
vv	Data Version
ll	Midimap Number ls byte
mm	Midimap Number ms byte

Offset	Name	Range
0	Midimap Name	12 chars, ASCII 32-127
12	Ch. Program	See <i>PROGRAM NUMBERS</i>
13	Ch. Bank	0-4, See <i>PROG. NUMBERS for bank #s</i>
14	Ch. Volume	0-127
15	Ch. Pan	± 7 , -8 = Preset
16	Ch. Mix Bus	-1 = preset, 0-3 Main, Sub1, FxA, FxB
17	Ch. Enable	0-1, Off, On
18	Ch. ProgChg Enbl	0-1, Off, On
19	Ch. BankChg Enbl	0-1, Off, On
20	Ch. VolCtl Enbl	0-1, Off, On
21	Ch. PanCtl Enbl	0-1, Off, On
22	Ch. PWhl Enbl	0-1, Off, On
23	Ch. MPress Enbl	0-1, Off, On
24	Ch. PPress Enbl	0-1, Off, On
25	Ch. Ctl. A Enbl	0-1, Off, On
26	Ch. Ctl. B Enbl	0-1, Off, On
27	Ch. Ctl. C Enbl	0-1, Off, On
28	Ch. Ctl. D Enbl	0-1, Off, On
29	Ch. Ftsw. 1 Enbl	0-1, Off, On
30	Ch. Ftsw. 2 Enbl	0-1, Off, On
31	Ch. Ftsw. 3 Enbl	0-1, Off, On
...		for 16 channels (20 parms each)
332	Prog Map	-1 for None, 0-3
333	FX A Type	See <i>EFFECTS TYPES</i>
334	FX A Parm Vals	See <i>EFFECTS TYPES</i>

Offset	Name	Range
...		10 parm values
344	FX B Type	See <i>EFFECTS TYPES</i> chart
345	FX B Parm Vals	See <i>EFFECTS TYPES</i> chart
...		10 parm values
355	FX A Amt	0-100%
356	FX B Amt	0-100%
357	B->A Amt	0-100%, 101 = B->A Only
358	FX A Bus	0-2, Main, Sub1, Sub2
359	FX B Bus	0-2, Main, Sub1, Sub2
	cs	Checksum
F7	End of SysEx Status	

• **Parameter Request**

Request a parameter value. An unknown parameter number will respond with a value of zero. Individual parameter editing uses a unique parm number for each editable parm. See *PARAMETER NUMBERS* chart for a listing of the parameters.

F0	SysEx Status Byte
18	E-mu Mfg. ID
0C	Morpheus Product ID
dd	Device ID 0-15
02	Command ID
pl	Parm Number ls byte
pm	Parm Number ms byte
F7	End of SysEx Status

• **Parameter Data**

The format of a parameter value request response is as follows.

F0	SysEx Status Byte
18	E-mu Mfg. ID
0C	Morpheus Product ID
dd	Device ID 0-15
03	Command ID
pl	Parm Number ls byte
pm	Parm Number ms byte
vl	Parm Value ls byte
vm	Parm Value ms byte
F7	End of SysEx Status

- ***Tuning Table Request***

F0	SysEx Status Byte
18	E-mu Mfg. ID
0C	Morpheus Product ID
dd	Device ID 0-15
04	Command ID
bb	Table Number, 0 - MAX TUNETABLE
F7	End of SysEx Status

- ***Tuning Table Data***

F0	SysEx Status Byte
18	E-mu Mfg. ID
0C	Morpheus Product ID
dd	Device ID 0-15
05	Command ID
bb	Table Number (only 1 table in Morpheus)
ll	ls byte of Tune Value
mm	ms byte of Tune Value
...	128 total entries
F7	End of SysEx Status

- ***Program Map Request***

F0	SysEx Status Byte
18	E-mu Mfg. ID
0C	Morpheus Product ID
dd	Device ID 0-15
06	Command ID
bb	Map Number, 0-3
F7	End of SysEx Status

• ***Program Map Data***

F0	SysEx Status Byte
18	E-mu Mfg. ID
0C	Morpheus Product ID
dd	Device ID 0-15
07	Command ID
bb	Map Number, 0-3
ll	ls byte of Program Number
mm	ms byte of Program Number
...	128 total entries
F7	End of SysEx Status

• ***Master Settings Request***

F0	SysEx Status Byte
18	E-mu Mfg. ID
0C	Morpheus Product ID
dd	Device ID 0-15
08	Command ID
F7	End of SysEx Status

• ***Master Settings Data***

A master settings request responds with streams of parmnumber/parmvalue pairs in running status mode. Two separate dumps are sent: first global parms, then scratch midimap parms.

F0	SysEx Status Byte
18	E-mu Mfg. ID
0C	Morpheus Product ID
dd	Device ID 0-15
03	Command ID
pl	lsb Parm Number
pm	msb Parm Number
vl	lsb Parm Value
vm	msb Parm Value
...	Global Parms

F7	End of SysEx Status
then...	
F0	SysEx Status Byte
18	E-mu Mfg. ID
0C	Morpheus Product ID
dd	Device ID 0-15
03	Command ID
pl	lsb Parm Number
pm	msb Parm Number
vl	lsb Parm Value
vm	msb Parm Value
...	Scratch Midimap Parms
F7	End of SysEx Status

- **Version Request**

Use this command to determine the model (version code) and the software revision. different models and revisions may have more or less features, so use the command to verify what machine is being controlled.

F0	SysEx Status Byte
18	E-mu Mfg. ID
0C	Morpheus Product ID
dd	Device ID 0-15
0A	Command ID
F7	End of SysEx Status

- **Version Data**

F0	SysEx Status Byte
18	E-mu Mfg. ID
0C	Morpheus Product ID
dd	Device ID 0-15
0B	Command ID
02	Version Code for Morpheus
r1	Revision x.xx (i.e. 1.00)
r2	
r2	
F7	End of SysEx Status

• **Configuration Request**

Use this command to get configuration information. Note that much of the information is dynamic (e.g. if RAM card is installed or not) and therefore the information is only valid for some window of time. This command can be used to determine if a card is presently installed.

F0	SysEx Status Byte
18	E-mu Mfg. ID
0C	Morpheus Product ID
dd	Device ID 0-15
0C	Command ID
F7	End of SysEx Status

• **Configuration Data**

See the Request Command Description for information regarding the validity of this information.

F0	SysEx Status Byte
18	E-mu Mfg. ID
0C	Morpheus Product ID
dd	Device ID 0-15
0D	Command ID
pl	lsb Number of Presets
pm	msb Number of Presets
s1	Sound Set Rank A
sl	lsb Number of Insts Rank A
sm	msb Number of Insts Rank A
s2	Sound Set Rank B
sl	lsb Number of Insts Rank B
sm	msb Number of Insts Rank B
hl	lsb Number of Hyperpresets
hm	msb Number of Hyperpresets
hl	lsb Number of Filters
hm	msb Number of Filters
ml	lsb Number of Midimaps
mm	msb Number of Midimaps
el	lsb Number of A Effects
em	msb Number of A Effects
el	lsb Number of B Effects
em	msb Number of B Effects
F7	End of SysEx Status

- **Instrument List Request**

Request list of available instruments. *See data message for format of response.*

F0	SysEx Status Byte
18	E-mu Mfg. ID
0C	Morpheus Product ID
dd	Device ID 0-15
0E	Command ID
F7	End of SysEx Status

- **Instrument List Data**

List of currently available instruments and their ids in the order they appear in the box. *See INSTRUMENT NUMBERS for a description of the instrument number.*

F0	SysEx Status Byte
18	E-mu Mfg. ID
0C	Morpheus Product ID
dd	Device ID 0-15
0F	Command ID
nl	lsb Number of Instruments
nm	msb Number of Instruments
il	lsb Instrument Number
im	msb Instrument Number
nn	Instrument Name
...	11 ASCII Chars per Instrument
00	String Null Terminator
...	for number of instruments
F7	End of SysEx Status

- **Filter List Request**

Request list of available filters. *See data message for format of response.*

F0	SysEx Status Byte
18	E-mu Mfg. ID
0C	Morpheus Product ID
dd	Device ID 0-15
56	Command ID
F7	End of SysEx Status

• **Filter List Data**

List of currently available filters and their ids in the order they appear in the box. See *FILTER TYPES* for information regarding interpretation of this data.

F0	SysEx StatusByte
18	E-mu Mfg. ID
0C	Morpheus Product ID
dd	Device ID 0-15
57	Command ID
nl	lsb Number of Filters
nm	msb Number of Filters
il	lsb Filter Number
im	msb Filter Number
nn	Filter Name
...	11 ASCII chars per instrument
00	String Null Terminator
tl	lsb of Transform Number
tm	msb of Transform Number
...	for number of filters
F7	End of SysEx Status

• **Preset List Request**

Request list of available presets. See *data message for format*.

F0	SysEx Status Byte
18	E-mu Mfg. ID
0C	Morpheus Product ID
dd	Device ID 0-15
12	Command ID
F7	End of SysEx Status

- **Preset List Data**

List of currently available presets in the order they appear in Morpheus.

F0	SysEx Status Byte
18	E-mu Mfg. ID
0C	Morpheus Product ID
dd	Device ID 0-15
0F	Command ID
nl	lsb Number of Presets
nm	msb Number of Presets
nn	Preset Name
...	12 ASCII chars per instrument
00	String Null Terminator
...	for number of presets
F7	End of SysEx Status

- **Hyperpreset List Request**

Request list of available Hypers. *See data message for format of response.*

F0	SysEx Status Byte
18	E-mu Mfg. ID
0C	Morpheus Product ID
dd	Device ID 0-15
50	Command ID
F7	End of SysEx Status

- **Hyperpreset List Data**

Currently available Hypers in the order they appear in Morpheus.

F0	SysEx Status Byte
18	E-mu Mfg. ID
0C	Morpheus Product ID
dd	Device ID 0-15
51	Command ID
nl	lsb Number of Hyperpresets
nm	msb Number of Hyperpresets
nn	Hyperpreset Name
...	12 ASCII Chars per Hyperpreset
00	String Null Terminator
...	for number of Hyperpresets
F7	End of SysEx Status

• **Midimap List Request**

Request list of available midimaps. *See the data message for the format of the response.*

F0	SysEx Status Byte
18	E-mu Mfg. ID
0C	Morpheus Product ID
dd	Device ID 0-15
52	Command ID
F7	End of SysEx Status

• **Midimap List Data**

List of currently available midimaps in the order as they appear in Morpheus.

F0	SysEx Status Byte
18	E-mu Mfg. ID
0C	Morpheus Product ID
dd	Device ID 0-15
53	Command ID
nl	lsb Number of Midimaps
nm	msb Number of Midimaps
nn	Midimap Name
...	12 ASCII Chars per Midimap
00	String Null Terminator
...	for number of Midimap
F7	End of SysEx Status

• **Effect List Request**

Request list of available effects. *See the data message for the format of the response.*

F0	SysEx Status Byte
18	E-mu Mfg. ID
0C	Morpheus Product ID
dd	Device ID 0-15
54	Command ID
F7	End of SysEx Status

- **Effect List Data**

List of currently available effects and their ids in the order they appear in the box. See *EFFECT TYPES* for information regarding the interpretation of this data.

F0	SysEx Status Byte
18	E-mu Mfg. ID
0C	Morpheus Product ID
dd	Device ID 0-15
55	Command ID
nl	lsb Number of A Effects
nm	msb Number of A Effects
il	lsb Effect ID
im	msb Effect ID
nn	Effect Name
...	12 ASCII Chars per Effect
00	String Null Terminator
pl	lsb Effect Number of Params
pm	msb Effect Number of Params
nn	Effect Parm Name
...	11 ASCII Chars per Effect Parm
00	String Null Terminator
vl	lsb Parm Min Value
vm	msb Parm Min Value
vl	lsb Parm Max Value
vm	msb Parm Max Value
vl	lsb Parm Default Value
vm	msb Parm Default Value
...	for number of params for each effect
nl	lsb Number of B Effects
nm	msb Number of B Effects
...	same format as for A Effect List
F7	End of SysEx Status

MISCELLANEOUS DOCUMENTATION

• *Patchcord Sources*

The MIDI patchcord sources are unique across all Proteus type products. The note-on patchcords, valid for Morpheus, are as follows:

MIDI Value	Description
0	Key
1	Velocity
2	Pitchwheel
3	Control A
4	Control B
5	Control C
6	Control D
7	Mono Pressure
8	Free-run Function Generator

The realtime patchcord sources, valid for Morpheus, are as follows:

MIDI Value	Description
0	Pitchwheel
1	Control A
2	Control B
3	Control C
4	Control D
5	Mono Pressure
6	Poly Pressure
7	LFO 1
8	LFO 2
9	Auxiliary Envelope
10	Function Generator 1
11	Function Generator 2
12	Free-run Function Generator

- **Patchcord Destinations**

The MIDI patchcord destination numbers are unique across all Proteus type products. Note-on and realtime numbers are shared. The chart shows whether a cord is available to note-on (NO) realtime (RT) or both. The patchcord destinations available to Morpheus are as follows:

MIDI Value	Description	NO/RT Availability
0	Off	RT/NO
1	Pitch	RT/NO
2	PitchP	RT/NO
3	PitchS	RT/NO
4	Volume	RT/NO
5	VolumeP	RT/NO
6	VolumeS	RT/NO
7	Attack	RT/NO
8	AttackP	RT/NO
9	AttackS	RT/NO
10	Decay	RT/NO
11	DecayP	RT/NO
12	DecayS	RT/NO
13	Release	RT/NO
14	RelP	RT/NO
15	RelS	RT/NO
16	XFade	RT/NO
17	Lfo1Amt	RT/NO
18	Lfo1Rt	RT/NO
19	Lfo2Amt	RT/NO
20	Lfo2Rt	RT/NO
21	AuxAmt	RT/NO
22	AuxAtt	RT/NO
23	AuxDec	RT/NO
24	AuxRel	RT/NO
25	Start	NO
26	StartP	NO
27	StartS	NO
28	Pan	RT/NO
29	PanP	RT/NO
30	PanS	RT/NO
31	Tone	NO

MIDI Value	Description	NO/RT Availability
32	ToneP	NO
33	ToneS	NO
34	Morph	RT/NO
35	MorphP	RT/NO
36	MorphS	RT/NO
37	Trans2	NO
38	Trans2P	NO
39	Trans2S	NO
40	PortRt	RT/NO
41	PortRtP	RT/NO
42	PortRtS	RT/NO
43	FG1Amt	RT/NO
44	FG2Amt	RT/NO
45	FltLev	NO
46	FltLevP	NO
47	FltLevS	NO
48	FreqTrk	NO
49	FreqTrkP	NO
50	FreqTrkS	NO

• **Function Generator Shapes**

The function generator shapes are as follows:

MIDI Value	Shape Name	MIDI Value	Shape Name
0	Linear	12	Squeeze
1	Expo+1	13	FastLn1
2	Expo+2	14	FastLn2
3	Expo+3	15	FastLn3
4	Expo+4	16	MedLn1
5	Expo+5	17	MedLn2
6	Expo+6	18	SlwRmp1
7	Expo+7	19	SlwRmp2
8	Circ1.4	20	Bloom
9	Circ1.6	21	Bloom2
10	Circ1.8	22	Cr1.16R
11	Cir1.16	23	Cir1.8R

MIDI Value	Shape Name	MIDI Value	Shape Name
24	Cir1.6R	43	Chaos50
25	Cir1.4R	44	Chaos66
26	SlwCrv1	45	Chaos75
27	SlwCrv2	46	Chaos95
28	DelayDC	47	Chaos99
29	DCdelay	48	LinShfl
30	Curve2X	49	LnShfl2
31	Curv2XB	50	RandomA
32	Curv2XC	51	RandomB
33	ZizZag1	52	RandomC
34	ZizZag2	53	RandomD
35	ZizZag3	54	RandomE
36	Chaos03	55	RandomF
37	Chaos06	56	RandomG
38	Chaos12	57	RandomH
39	Chaos16	58	RandomI
40	Chaos25	59	RandomJ
41	Chaos33	60	RandomK
42	Chaos37	61	RandomL
		62	RandomZ

• *Function Generator Conditions*

The function generator condition values are shared between preset funcgens and hyper funcgens, though some values are excluded in the hyper func gen. The chart shows the numbers and the availability.

MIDI Value	Description	Availability
0	Never	Preset, Hyperpreset
1	AlwaysEnd	Preset, Hyperpreset
2	NoteOnEnd	Preset, Hyperpreset
3	NoteOnImm	Preset, Hyperpreset
4	NoteOffEnd	Preset, Hyperpreset
5	NoteOffImm	Preset, Hyperpreset
6	LFO1End	Preset
7	LFO2End	Preset
8	Footswitch1End	Preset, Hyperpreset
9	Footswitch1Imm	Preset, Hyperpreset

MIDI Value	Description	Availability
10	Footswitch2End	Preset, Hyperpreset
11	Footswitch2Imm	Preset, Hyperpreset
12	Footswitch3End	Preset, Hyperpreset
13	Footswitch3Imm	Preset, Hyperpreset
14	VelocityEnd	Preset
15	KeyEnd	Preset

• *Function Generator Levels*

The funcgen level parm value is comprised of two bitfields.

Funcgen Level = (levelType << 8) + levelValue

bits 8-13 = level type, 0-3

bits 0-7 = level value, +-127

The level types are defined as follows:

MIDI Value	Description
0	absolute level
1	delta level
2	random absolute level
3	random delta level

• *Filter Types*

Use the FILTER LIST command to get a list of the currently available filter names, ids and transform number. the filter type number sent via sysex are unique ids. (they are not the index into the screens) The transform number is used to determine the active parms for that filter. The number of parms active for any filter is determined by the number of frames in the filter.

Number of Frames	Active Parms
2	Morph
4	Morph, Frequency Track
6	Morph, Frequency Track, Transform 2
8	Morph, Frequency Track, Transform 2

Transform	Filter Type
0	2 frame filter
1	4 frame “square” filter
2	6 frame “phantom cube” filter
3	8 frame “cube” filter
4	unused
5	4 frame “square” filter, gain reduced

• *Effect Types*

Use the EFFECT LIST command to get a list of the currently available EFFECTS and their IDs. The effect type number sent via SysEx are unique IDs. (they are not the index into the screens). Note that the A and B effect IDs do not overlap. e.g. the A effect StereoFlange does not have the same ID as the B effect StereoFlange.

• *Parameter Numbers*

The following parameter numbers are in decimal.

Parm Number	Parm Description	Range
0-128	Proteus Preset Parm	
256	Basic Channel	0-15
257	Channel Volume	0-127
258	Channel Pan	± 7 , -8 = P
259	Current Program	0-MAXPROGRAM
260	Master Tune	± 64 Semitones
261	Master X-pose	± 12 Midi Keys (semitones)
262	Global Bend	0-12 \pm Semitones
263	Global Velcurve	0-8, 0 = Off
264	Midi Mode	0-3, Omni, Poly, Multi, Mono
265	Unused	
266	Control A	0-31
267	Control B	0-31
268	Control C	0-31
269	Control D	0-31
270	Footswitch 1	64-79
271	Footswitch 2	64-79
272	Footswitch 3	64-79
273	Midi Modechange Enable	0-1, Disabled, Enabled

Parm Number	Parm Description	Range
274	SysEx Device ID	0-15
...	Unused	
320	Current Midimap	0-MAXMAP
...	Unused	
323	Auto Select	0-1, Off, On
324	Packet Delay	0-999 (approx. 600 μSecs/unit)
325	Proteus SysEx	0-1, Off, On
326	Compare Mode	0-1, Off, On
..	Unused	
2048-2407	Midimap Vers. 1 Parms	See <i>MIDIMAP DATA</i>
8192-8469	Preset Vers. 1 Parms	See <i>PRESET DATA</i>
8704-8940	Hyper Vers. 1 Parms	See <i>HYPERPRESET DATA</i>

• **Instrument Numbers**

Use the INSTRUMENT LIST commands to get a list of the IDs and names as they appear in the box. Instrument numbers are comprised of two bitfields. (romset<<8) + index.

bits 8-13 = romset number.

bits 0-7 is an index into the romset.

The Morpheus romset is 7. (Therefore instrument numbers start at 1792).

• **Program Numbers**

The mapping of program numbers for preset changes and midimap program number editing is as follows:

MIDI Bank	Program Numbers	Program Type
0	0-127	RAM Presets
1	128-255	ROM Presets
2	256-383	RAM Hypers
3	383-511	Card Presets
4	512-639	Card Hypers

• 14-bit Signed 2's Complement Numbers

If the data value is negative, you must first take the 2's complement of the number: In the case of a 14-bit number this is equivalent to adding 16384 to the original negative value.

To fit the 7-bit MIDI protocol, numbers must be “nibble-ized”.

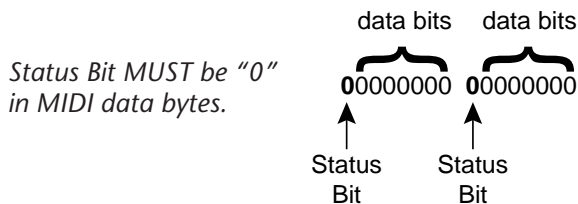

To get the 14-bit nibble-ized value (of a positive value or a 2's complemented negative value):

msb = value DIV 128 (divide and ignore the remainder)

lsb = value MOD 128 (divide and use only the remainder)

To go the other way (convert 14 bit signed 2's complement to a signed real number)

raw Value = (msb*128) + lsb (gives you the unsigned raw value)

if raw Value \geq 8192 (8192 = 2^{13})

then signed Value = raw value - 16384 (16384 = 2^{14})

Example: To find the “nibble-ized” Hex value of -127:

- 1) $-127 + 16384 = \mathbf{16257}$
- 2) $16257 \div 128 = \mathbf{127 \text{ r-1}}$
- 3) 127 in Hex = **7F** = msb
- 4) 1 in Hex = **01** = lsb
- 5) Parameter value would be transmitted as **01 7F**

Example: To find the “nibble-ized” Hex value of parameter number 257:

- 1) $257 \div 128 = \mathbf{2 \text{ r-1}}$
- 2) 2 in Hex = **02** = msb
- 3) 1 in Hex = **01** = lsb
- 4) Parameter number would be transmitted as **01 02**

HOW TO EDIT AN INDIVIDUAL PRESET PARAMETER

Parameter data editing is accomplished using the format described on page 234.

F0	System Exclusive Status Byte
18	E-mu Mfg. ID
0C	Morpheus Product ID Byte
dd	Device ID 0-15 (<i>usually 00</i>)
03	Command ID - Parameter Data (<i>from Command Summary</i>)
pl	Parameter Number ls byte
pm	Parameter Number ms byte
vl	Parameter Value ls byte
vm	Parameter Value ms byte
F7	EOX

Example: Change the waveshape of LFO 1 to Random.

- 1) Find the command ID for the operation you wish to perform from the Command Summary on page 227 (03 = Parameter Data).
- 2) Next, we need to find the preset parameter number for LFO 1 waveshape in Hexadecimal. This will be the Parameter Number portion of the message.
The preset parameter offset numbers shown on pages 229-231 must be added to the base offsets in order to get the actual parameter number.
- 3) The preset parameter list shows LFO 1 waveshape as 93 (*page 229*). The base offset number for preset parameters is 8192 (*page 250*). Add these numbers to get the actual parameter number. **8192 + 93 = 8285**.
- 4) Now the parameter number must be converted into 14-bit 2's complement in order to fit into the MIDI format. The instructions are given on the previous page, but we will go through the process again.
 - a) $8285 \div 128 = 64$ **r93**
 - b) 64 in Hex = **40** = msb
 - c) 93 in Hex = **5D** = lsb
- 5) The least significant byte is always sent first. The MIDI SysEx string now looks like this: **F0 18 0C 00 03 5D 40 XX XX F7**. We're still missing the value data to select the desired waveform.
- 6) From the table on page 229 you can find out that "0" corresponds to the random wave. Zero is the easiest number to convert. 0 in 14-bit 2's complement is still 0, or more strictly speaking **00 00**.
- 7) The completed message is: **F0 18 0C 00 03 5D 40 00 00 F7**.
- 8) If we wanted to change the waveform to Square, the message would be: **F0 18 0C 00 03 5D 40 04 00 F7**. Substitute **04 00** for **00 00** in the data bytes (lsb first).

••• In all of these examples, the process of Hexadecimal conversion has been omitted. Use a table or a Hex calculator to convert decimal numbers to Hexadecimal.

HOW TO EDIT A GLOBAL PARAMETER

Parameter data editing is accomplished using the format described on page 234.

F0	System Exclusive Status Byte
18	E-mu Mfg. ID
0C	Morpheus Product ID Byte
dd	Device ID 0-15 (<i>usually 00</i>)
03	Command ID - Parameter Data (<i>from Command Summary</i>)
pl	Parameter Number ls byte
pm	Parameter Number ms byte
vl	Parameter Value ls byte
vm	Parameter Value ms byte
F7	EOX

Example: Change the Pan value of the Basic channel to “P”.

- 1) We need to find the preset parameter number for Channel Pan in Hexadecimal. This will be the Parameter Number portion of the message.

The Channel Pan parameter is found on page 249. This is the actual number and not an offset, so we only need to convert it to 14-bit 2's complement. The parameter number for Channel Pan = 258.

- a) $258 \div 128 = 2$ r2
- b) 2 in Hex = **02** = msb
- c) 2 in Hex = **02** = lsb

- 2) The least significant byte is always sent first. The MIDI SysEx string now looks like this: **F0 18 0C 00 03 02 02 XX XX F7**. We're still missing the value data to select the pan position.

- 3) From the table on page 249 you can find out that “-8” corresponds to Preset Pan. For negative numbers, add 16384 to the original negative value. $16384 - 8 = 16376$.

- 4) Next we convert this number into “nibblized” Hex form.

- a) $16376 \div 128 = 127$ r120
- b) 127 in Hex = **7F** = msb
- c) 120 in Hex = **78** = lsb

- 5) The completed message is: **F0 18 0C 00 03 02 02 78 7F F7**.

One More

If we wanted to change the Basic Channel to 5, the message would be: **F0 18 0C 00 03 00 02 04 00 F7**. Basic Channel is two parameters before Pan in the list, Subtract 2 from the Parameter Number ($02\ 02 - 2 = 00\ 02$). MIDI channels begin at 00; therefore channel 5 would be 4. Convert 4 into Hex = **04**. (LSB first = 04 00.)

••• See MIDI Mode in the Master Menu for additional information on Device ID.

••• Note: Changing Basic Channel Pan is the same as changing Midimap Pan.

••• See MIDI Mode in the Master Menu for additional information on Device ID.

••• In all of these examples, the process of Hexadecimal conversion has been omitted. Use a table or a Hex calculator to convert decimal numbers to Hexadecimal.

HOW TO EDIT A MIDIMAP PARAMETER

By popular request we'll offer one more example. Editing a Midimap is just another type of parameter data editing. The number given for the parameters is an OFFSET which will be added to the base number for MidiMap given on page 250. The format for parameter editing is the same as always.

F0	System Exclusive Status Byte
18	E-mu Mfg. ID
0C	Morpheus Product ID Byte
dd	Device ID 0-15 (<i>usually 00</i>)
03	Command ID - Parameter Data (<i>from Command Summary</i>)
pl	Parameter Number ls byte
pm	Parameter Number ms byte
vl	Parameter Value ls byte
vm	Parameter Value ms byte
F7	EOX

Example: Change the Amount of FX A to 50%.

- 1) Find the command ID for the operation you wish to perform from the Command Summary (03 = Parameter Data).
- 2) Next, we need to find the Midimap parameter number for FXA Amount in Hexadecimal. This will be the Parameter Number portion of the message.
The Midimap parameter offset numbers shown on pages 233-234 must be added to the base offset in order to get the actual parameter number.
- 3) The Midimap parameter list shows FXA Amount as 355 (*page 234*). The base offset number for Midimap parameters is 2048 (*page 250*). Add these numbers to get the actual parameter number. $2048 + 355 = 2403$.
- 4) Now the parameter number must be converted into 14-bit 2's complement in order to fit into the MIDI format. These instructions were given earlier, but we'll go through the process one more time.
 - a) $2403 \div 128 = 18$ r99
 - b) 18 in Hex = 12 = msb
 - c) 99 in Hex = 63 = lsb
- 5) The least significant byte is always sent first. The MIDI SysEx string now looks like this: **F0 18 0C 00 03 63 12 XX XX F7**. We're still missing the value data to set the Amount.
- 6) From the table on page 234 we see that the FXA Amount range is 0-100%. Simply insert the desired amount in Hexadecimal.
50 in Hex = 32, or **00 32**.
- 7) The completed message is (*lsb first*): **F0 18 0C 00 03 63 12 32 00 F7**.

A

"A" effects list 42
 A-B-C-D controllers 24, 97-98, 122-124
 About sampling 9
 Aftertouch 71
 Alternate volume envelope 73, 105, 143
 Attack 73, 144
 Audio outputs 5, 6
 Auto select 26
 Auxiliary envelope 73, 116

B

"B" effects list 53
 B3 waves 167
 Bandpass filter 85
 Bank select 33
 Basic channel 22
 Basic channel, changing via SysEx 253
 Basic operation 11
 Basic setup 5

C

Card slot 12
 Chamber reverb 43, 44
 Channel -> Preset/Hyper 31
 Channel pan 14
 Channel volume 14
 Chorus 49
 Compare 26, 59, 101
 Conditional jump 120
 Connections 5-8
 Continuous controller 97
 Contour *See* Envelope Generator
 Controller ABCD 24, 71
 Copy 131
 Copy button 13
 Cross delay 53
 Cross-switch 111
 Cross-switch point 113
 Crossfade 111
 Crossfade amount 112
 Crossfade balance 112
 Crossfade direction 112
 Crossfade mode 111
 Cursor 13

D

Data entry control 13
 DCA 93
 Decay 73, 144
 Delay 50, 53 73
 Delay times, envelope 222
 Demo sequence select 13
 Demo sequences 16
 Dimensions: 223
 Double + Detune 106, 144
 Drawbar diagrams 169
 Drum priority 110

E

Early reflection 43
 Editing presets 69, 139
 Effect bus architecture 40
 Effect processor A 34
 Effect processor B 35
 Effect returns 8
 Effects
 Effects location 39
 Effect output routing 40
 Effect programming 41
 Envelope 143, 144
 Envelope generator 71, 73
 Envelope generator times 222

F

Factory presets 162-163
 RAM presets 162
 ROM presets 163
 Feedback 47
 Filter 84-92, 113, 154, 157
 Filter frequency tracking 114
 Filter level 113, 151
 Filter modulation 84
 Filter reverse 116
 Filter transform 2 115
 Filter type 152
 Fine pitch tuning 105
 First note priority 110
 Flanger 46
 Footswitch 72
 Footswitch control 124
 Free-run function generator 64, 65, 81
 Frequency tracking 114, 151

F (cont)

- Function generator 71, 76, 118
 - Conditional jumps 66, 77
 - Delta level 79
 - Pitch intervals 222
 - Random delta 81
 - Random level 79
- Function generator amount 121
- Function generator curves 214-221
- Fuzz 54
- Fuzz lite 54
- FX A 34
- FX A Amount, changing via SysEx 254
- FX amount 35
- FX B 35
- FX output select 36

G

- Glide *See* Portamento
- Global velocity curve 20

H

- Hall 43, 44
- Harmonic waveforms 163
- Headphones 5
- High note priority 110
- High pass filter 85
- Hold 73, 144
- Home/Enter 13
- Hyperpreset 4, 59
 - Portamento mode 64
 - Preset to zone assignment 60
 - Zone key range 61
 - Zone pan 61
 - Zone pitch tune 63
 - Zone transpose 63
 - Zone velocity offset 63
 - Zone velocity range 62
 - Zone volume 61
- Hyperpreset menu select button 12
- Hyperpreset name 60

I

- ID number 22
- Instruments 4, 93, 140, 162-166

K

- Key number 96
- Key range
- Key velocity 71
- Keyboard center 126
- Keyboard key 71
- Keyboard pressure 71
- Keyboard tuning 126
 - 19-tone tuning 126
 - Equal tuning 126
 - Gamelan 126
 - Just C tuning 126
 - Vallotti tuning 126

L

- Last note priority 110
- Layered keyboard 104
- LFO 47, 75, 147
 - Amount 117
 - Delay 117
 - Rate 117
 - Shape 117
 - Variation 117
- LFO wave
 - Random 75
 - Sawtooth 75
 - Sine 75
 - Square 75
 - Triangle 75
- Loop enable 108
- Loop offset 108
- Loop size 108
- Loop start 108
- Loop offset sample locations 211-213
- Low frequency oscillator 71, 75
- Low note priority 110
- Low pass filter 85

M

- Main controls 12, 13
- Master 19, 20
- Master menu select button 12
- Master tune 19
- Master menu 17, 57, 129
- Memory card 15
- MIDI
 - MIDI basic channel 22
 - MIDI activity LED 13

M (cont)

- MIDI basic channel 22
- MIDI channel selection 14
- MIDI controller amount 124
- MIDI controller assign 24
- MIDI enables 32
- MIDI footswitch control 24
- MIDI implementation chart 223
- MIDI in 5, 6, 7
- MIDI mode 22
- MIDI mode change 22
- MIDI modes 22
- MIDI out 6
- MIDI program change map 23
- MIDI realtime controls 97
- MIDI specifications 224-254
- MIDI sysex 226-254
- MIDI sysex tutorial 251-254
- MIDI sysex packet delay 25
- Midimap 29
 - Midimap pan 31
 - Midimap volume 31
- Midimap menu select button 12
- Midimap name 31
- Midimap select 15, 30
- Midipatch 72, 97
- Mix select 127
- Modulation 70
- Modulation sources 71, 95, 123
- Mono mode 22
- Morph
 - Morph offset 114, 151
- Multi mode 22
- Multi-timbral operation 16

N

- Nontranspose 108
- Notch filter 86
- Note-on modulation control 71, 94, 122

O

- Organ waveforms 164
- Omni mode 22
- Only, effect mode 35
- Output impedance: 223
- Output level: 214
- Output mix 31

P

- Pan 61, 93
- Parametric filters 87
- Percussion instrument locations 170-173
- Percussion instruments 168
- Performance setup 7
- Phaser 48
- Pitch tune 63
- Pitch wheel 124
- Pitch bend range 124
- Pitch wheel 71
- Plates, reverb 43
- Poles 86
- Poly mode 22
- Polyphonic key pressure 71
- Portamento 110
- Portamento mode 64, 111
- Portamento rate 110
- Portamento shape 110
- Power 8
- Power requirements: 223
- Power switch 13
- Preset 4
- Preset menu 101
- Preset menu select button 12
- Preset name 102
- Presets 160
- Pressure amount 124
- Primary alternate envelope 106
- Primary key range 104
- Primary filter type 113
- Primary instrument 102
- Program map select 34
- Program selection 14
- Programming basics 67
- Proteus sysex 26

Q

- Q 86

R

- Rain 43
- Realtime control 97
- Realtime modulation 71, 95, 123, 149
- Reference section 159
- Release 73, 144
- Reverb 42, 43
- Ring modulator 55

S

Sample rate 214
Sampled sounds listing 164
sampling 9
Save 147
Save hyperpreset 66
Save midimap 36
Save preset 127
Secondary alternate envelope 106
Secondary filter type 113
Secondary key range 104
Secondary instrument 102
Send MIDI data 24
Setup 5
Sequencer, using Morpheus 158-159
Shimmer 43
Solo mode 109
Solo mode priority 110
Sound delay 107, 145
Sound reverse 107
Sound splicing 146
Sound start 107, 145
Split keyboard 104
Studio setup 6
Sub 1 & 2 8
Sustain 73, 144
Synth mode 109
Synthesizer waves 166
Sysex 24, 226-254

T

Tap level 50
Technical specifications 223
Tone 84, 93
Tone filter 84, 93
Transform 2 152
Transpose 19, 63, 105
Tremolo 75
Tuning
 Coarse & fine tuning 63, 105
 Tuning to other instruments 19
 User key tuning 20, 126

U

User key tuning 20

V

Velocity curve 96, 125
Velocity offset 63
Velocity range 62
Vibrato 75
Viewing angle 26
Volume 61, 103, 141
Volume Control 12

W

Weight: 222
Wind mode 109

Z

Z-plane filter 84, 89, 93, 151
Z-plane filter descriptions 174-210
Zone 4, 59

110/220 8

Please read this warranty, as it gives you specific legal rights.

Length of Warranty

This warranty covers all defects in materials and workmanship for a period of one year from the date of purchase by the original owner, provided that the Warranty Registration Card is filled out and returned to E-mu Systems within 14 days from the date of purchase. Cases may arise where E-mu's Service Department or one of E-mu's authorized service centers will ask for a copy of your sales receipt to facilitate warranty service. Please keep your purchase receipt in a safe place.

E-mu Systems does not cover:

- Damages due to improper or inadequate maintenance, accident, abuse, misuse, alteration, unauthorized repairs, tampering, or failure to follow normal operating procedures as outlined in the owner's manual.
- Deterioration or damage of the cabinet.
- Damages occurring during any shipment of the product for any reason.
- An E-mu product that has in any way been modified by anyone other than E-mu Systems, Inc.

Limitation of Implied Warranties

No warranty is expressed or implied. E-mu Systems specifically disclaims the implied warranties of merchantability and fitness for a particular purpose.

Exclusion of Certain Damages

E-mu Systems' liability for a product found defective is limited to repair or replacement of the unit, at E-mu's option. In no event shall E-mu Systems be liable for damages based on inconvenience, whether incidental or consequential, loss of use of the unit, loss of time, interrupted operation or commercial loss, or any other consequential damages.

Some states do not allow limitation of the duration of implied warranties or the exclusion or limitation of incidental or consequential damages, so the above limitations and exclusions may not apply to you.

How To Obtain Warranty Service

All E-mu products are manufactured with the highest standards of quality. If you find that your instrument does require service, it may be done by an authorized E-mu service center. If you are unable to locate a service center in your area, please contact E-mu Systems Service Department at (408) 438-1921. They will either refer you to an authorized service center or ask that you return your instrument to the factory.

When returning an instrument to the factory, you will be issued a Return Authorization number (RA). Please label all cartons, shipping documents and correspondence with this number. E-mu suggests you carefully and securely pack your instrument for return to the factory. Mark the outside of the shipping carton clearly with your RA number. Send to E-mu Systems, Inc. 1600 Green Hills Road, Scotts Valley, California, 95066. You must pre-pay shipping charges to the service location. E-mu Systems will pay return shipping fees. You will be responsible for any damage or loss sustained during shipment in any direction.

