

CONTENTS

INTRODUCTION	5
Procussion	6
CONNECTION INSTRUCTIONS	7
Basic Pad Setup	7
Quick Setup for MIDI Keyboard	8
Keyboard Setup	9
Quick Setup for MIDI Drum Pads	10
Live Performance Setup	11
Electronic Drum Kit Setup	12
Overview of Outputs	13
BASIC OPERATION	15
Controls	17
Selecting Kits	18
Selecting MIDI Channels, Volume and Pan	18
Multi-Timbral Operation	19
Master Menu Functions	20
Master Tune	20
Transpose	21
Submix Outputs	21
MIDI Modes	22
Global Velocity Curve	22
Global Trigger Tempo	23
Zone Maps	23
User Zone Maps 1 + 2	24
Drum Replacement with the User Zone Maps	24
Procussion Factory Zone Assignment Chart	25
Envelope Mode	26
MIDI Enable	26
Program Change	26
MIDI Mode Change	27
MIDI Controller Assign	27
MIDI Footswitch Assign	28
MIDI Program -> Kit	28
Auto Select	29
Remote Edit	29
Send MIDI Data	30
Viewing Angle	30
Demo Sequence	31
About Procussion	32
PROGRAMMING BASICS	33
Modulation	36
Procussion Modulation Sources	37
Envelope Generators	38
Low Frequency Oscillators	39

CONTENTS

PROGRAMMING BASICS (cont)

Modulation Patches	40
Accent and Volume	40
Instrument Layer Block Diagram	41
Key Number	41
Stack Block Diagram	42
Velocity Curves	43
MIDI Realtime Controls	44
Stereo Mix Outputs	46

EDIT MENU 47

Enabling the Edit Menu	49
Procussion Block Diagram	50

Kit and Zone Programming Functions

Kit Name and Keyboard Character Charts	51
Stack Select	52
Key Range	52
Zone Tuning	52
Zone Volume	53
Zone Pan	53
Nontranspose	53
Assignment Mode	54
Zone Submix	55
Modulation Enable	55
Footswitch Enable	56
Modulation Patch 1 and 2	56
Footswitch Control	57
Velocity Curve	57
Trigger Tempo	59

Stack Programming Functions

Stack Name and Keyboard Character Chart	59
Stack Instruments	60
Stack Tune	60
Stack Volume	60
Stack Pan	60
Delay/Sound Start	61
Reverse	62
Alternate Envelope	62
Pitch Envelope	62
Low Frequency Oscillator	63
Stack Modulation Control	64
Stack Footswitch 3 and 4	65
Switch Mode	65
Switch Group	67
Switch Source	67
Switch Points	68
Audition Layer	68

CONTENTS

Copy and Save Functions

Copy Zone	68
Copy Stack	69
Save Kit	69

PROGRAMMING PROCUSSION 73

Creating a Custom Kit	73
Editing Kits	74
Programming Tutorial	75
Hi-Hat Investigation	81
Programming Tips and Ideas	82
Procussion Synthesis	83
Spatial Convolution	85
Using Procussion with a Sequencer	86
More Advanced Sequencing	86

REFERENCE SECTION 89

Factory Kit Listing	90
Standard Kit Layout	91
Factory Stack Listing	92
Instrument Listing	99
LFO, Delay and Envelope Times	103
Pitch Modulation Interval Charts	104
Zone Map Chart	105
Technical Specifications	106
MIDI Specifications	107

INDEX

WARRANTY

REGISTRATION CARD

INTRODUCTION

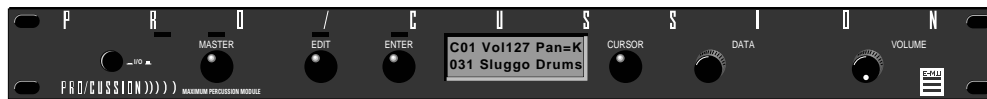

What is PROCUSSION?

Procussion is a multi-timbral percussion instrument whose sounds are based on actual digital recordings of “real” instruments. With Procussion, you can instantly have hundreds of different drum and percussion instruments at the tip of your drumstick.

Procussion begins with sound. Four megabytes of the highest quality 16 bit percussion samples selected from the Emulator III sound library and stored on ROM (Read Only Memory) for instant access.

But this is only the beginning. Procussion gives you the ability to literally take these sounds apart and re-assemble them into an almost limitless number of entirely new percussion sounds, combining parts of one instrument with another or with any of a selection of digital waveforms also stored on ROM. The extensive cross-switching functions allow a high degree of musical expression not normally attainable from sampled percussion instruments. The 16 bit samples are arranged into 128 kit locations, 64 of which are user-programmable.

Procussion also features 32 voice polyphony allowing you to take full advantage of its layering capabilities (up to 8 sounds on each key or drum pad) and its ability to respond multi-timbrally to all 16 MIDI channels makes it ideally suited for multitrack sequencing and composing using a MIDI sequencer.

Other features include 3 stereo outputs for individually processing sounds (also configurable as 6 polyphonic submixes with fully programmable panning), integral sends and returns to allow the addition of external effects units without the need for a separate mixer, and of course, an extensive MIDI implementation.

PROCUSSION INTRO

Procussion is organized as shown in the simplified diagram below.

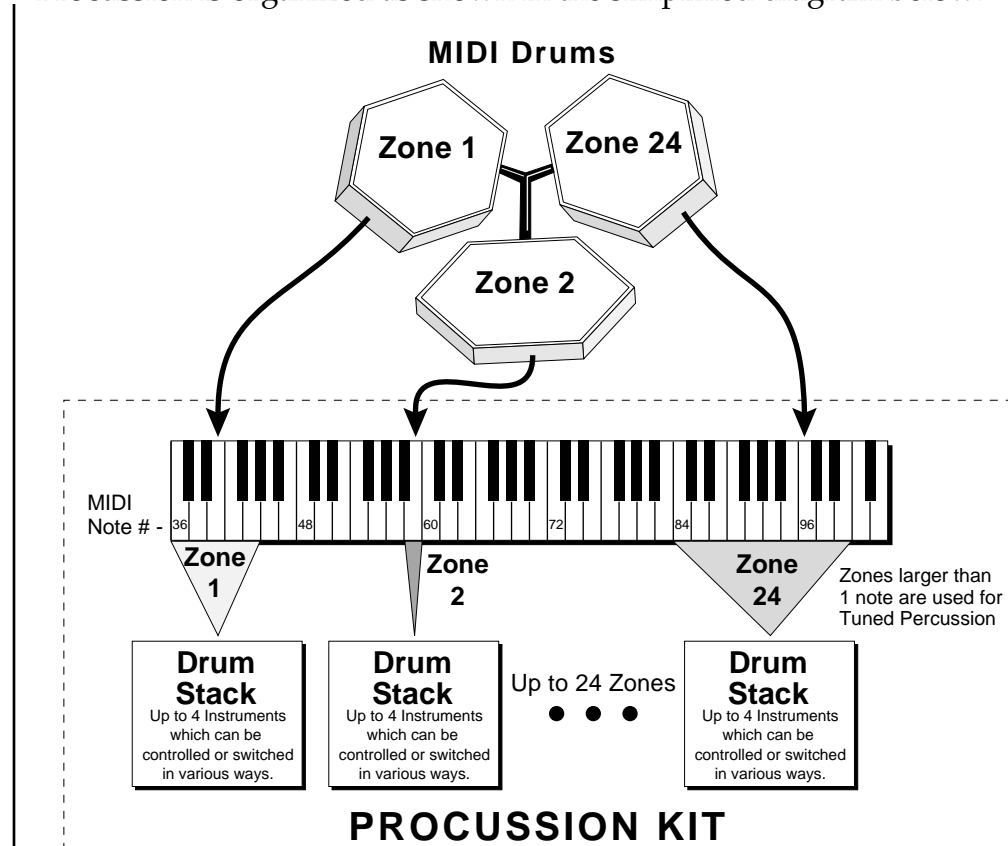

A number of sampled percussion instruments are mapped across a keyboard or set of drum pads. Each instrument has many individual attributes such as tuning, volume, pan, etc.

The *Kit* is a complete set of all program parameters for a set of up to 24 Procussion drum *Stacks*. There are 128 kit locations in the Procussion.

Kits 0-63 are unalterable factory kits; Kits 64-127 are user kits which can be changed.

Stacks, which can be made of up to 4 percussion *Instruments*, are assigned to MIDI key ranges called *Zones*. Up to 24 zones may be assigned in one kit.

The instruments in a stack can be modulated in many ways or switched on and off depending on various parameters such as velocity (how hard a drum is played) or perhaps the position of the high hat pedal, sticking speed, etc.

CONNECTION INSTRUCTIONS

Setup #1 BASIC PAD SETUP

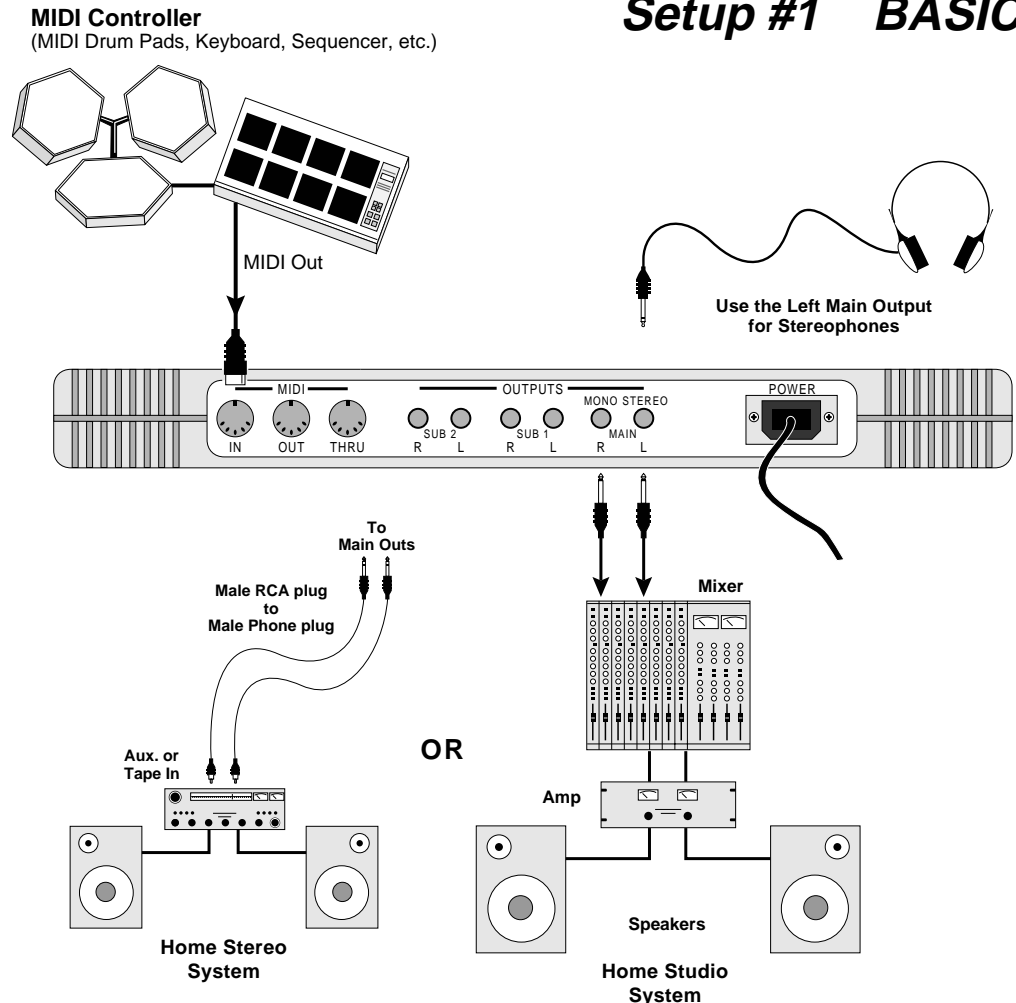

■ If Procussion does not seem to be responding correctly, make sure that both Procussion and your MIDI Controller are set to the same MIDI channel.

This diagram shows a typical equipment setup for the Procussion.

MIDI In - Procussion is controlled by MIDI messages received at the MIDI In connector. Connect the MIDI In of the Procussion to the MIDI Out connector of a MIDI controller such as a MIDI keyboard, MIDI Drum Pads or MIDI sequencer.

Outputs - Procussion is a high quality, stereo audio device. In order to reproduce its wide dynamic range and frequency response, use a high quality amplification and speaker system such as a keyboard amplifier or home stereo system. A stereo setup is highly desirable because of the added realism of stereophonic sound. Headphones can be used if an amplifier and speaker system is not available. Plug stereo headphones into the Left Main output jack. The Right Main output jack serves as a mono output when the left jack is not plugged in.

QUICK SETUP

Using the *PROCUSSION* with a MIDI Keyboard

These instructions will get you up and running in the shortest amount of time. Connect Procussion to your sound system and MIDI keyboard as shown on the following page and turn everything on.

SET LEVELS

- 1) Turn the Procussion's volume control to minimum.
- 2) Press the **Master** button on Procussion.
- 3) Turn the **Data** knob clockwise to the very last screen which reads, "DEMO SEQUENCE".
- 4) Press the **Cursor** button to move the flashing cursor to the bottom line in the display.
- 5) Press **Enter** to start the demo sequence, then slowly turn up the volume control to a comfortable listening level. You may have to adjust the volume of your sound system. Press **Enter** again to stop the demo.

PROCUSSION SETUP

The Zone Map function re-maps every kit in Procussion to fit your MIDI keyboard. This is much easier than having to modify each individual kit.

- 1) Press the **Master** button on Procussion.
- 2) Turn the **Data** knob to the screen which reads, "ZONE MAPS".
- 3) Verify that the bottom line of the display reads "Kit". If the display reads something other than "Kit", press the **Cursor** button to move the flashing cursor to the bottom line in the display, then press it again so that the flashing cursor line is underneath the word in the lower line. Turn the data knob until it does read "Kit".
- 4) Press the Master button to return to the main screen.
- 5) Play your MIDI keyboard. You should now be hearing sound. If not, verify that the MIDI light on Procussion flashes as the keys are played. If it doesn't flash, check the MIDI connection.
- 6) Turn the data knob clockwise to select another kit. Remember, Procussion has 128 different kits! Have fun.

Setup #2 KEYBOARD SETUP

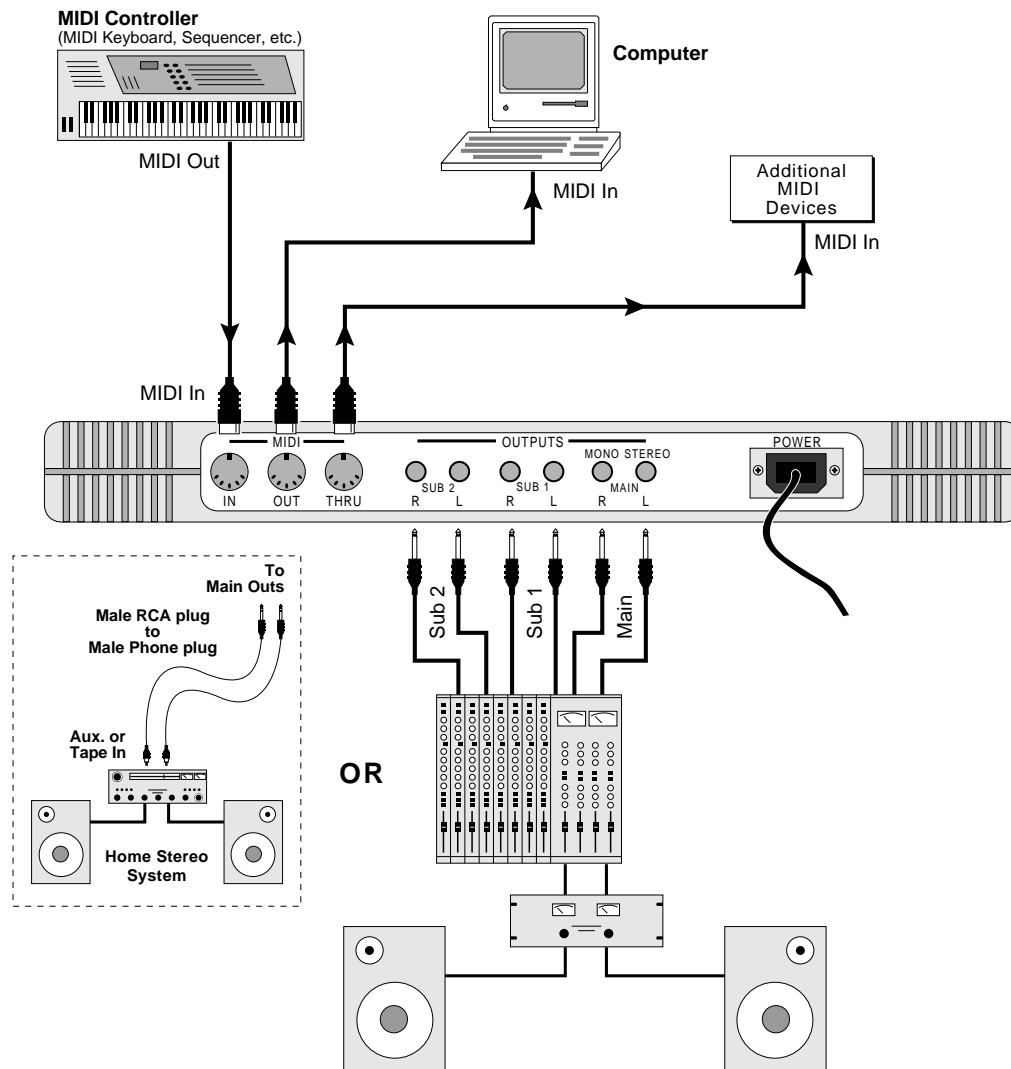

MIDI In - Procussion is controlled by MIDI messages received at the MIDI In connector. Any MIDI controller such as a MIDI keyboard, MIDI drum pads or a computer can be connected.

MIDI Out - The MIDI Out jack is normally used to transmit program data to a computer or other device.

MIDI Thru - MIDI Thru transmits an exact copy of the messages received at the MIDI In jack to additional MIDI devices.

Outputs - Procussion has three sets of programmable stereo outputs; Main, Sub 1, and Sub 2. Specific sounds can be routed to one of these stereo pairs in order to be further processed or mixed separately.

QUICK SETUP

Using the PROCUSSION with Drum Pads

These instructions will get you up and running in the shortest amount of time. Connect Procussion to your sound system and MIDI drum pads as shown on the facing page (or on page 7) and turn everything on.

- 1) Play your MIDI drum pads and verify that the MIDI light on Procussion flashes as the pads are played. If not, check the MIDI connection.
- 2) Set Procussion to Kit 000, "Ampitheater" (or any of the kits marked with an asterisk in the kit listing).
- 3) Assign each pad of your MIDI drum pad controller to a MIDI note number using the Standard Factory Kit Layout on page 91. Set the MIDI pads up however you like, but be sure to save your layout to the pad controller when you have finished.
- 4) Turn the data knob on Procussion clockwise to select another kit. Since you used one of the Standard Kits as your model, most other Procussion factory kits (marked *) will follow the same pad layout.

Your MIDI Controller assigns each Pad a MIDI Number

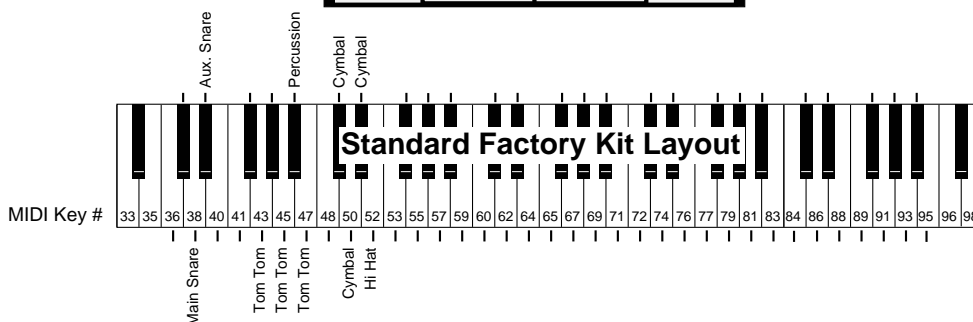
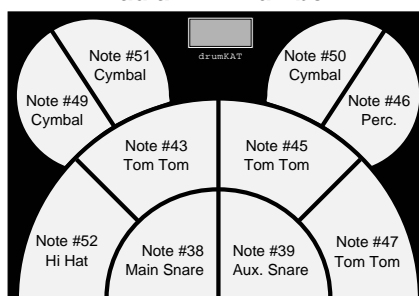

Use the Standard Factory Kit Layout to assign your Drum Pads so that most of the Procussion Factory Kits will match up with your pad assignments.

SETUP #3 LIVE PERFORMANCE SETUP

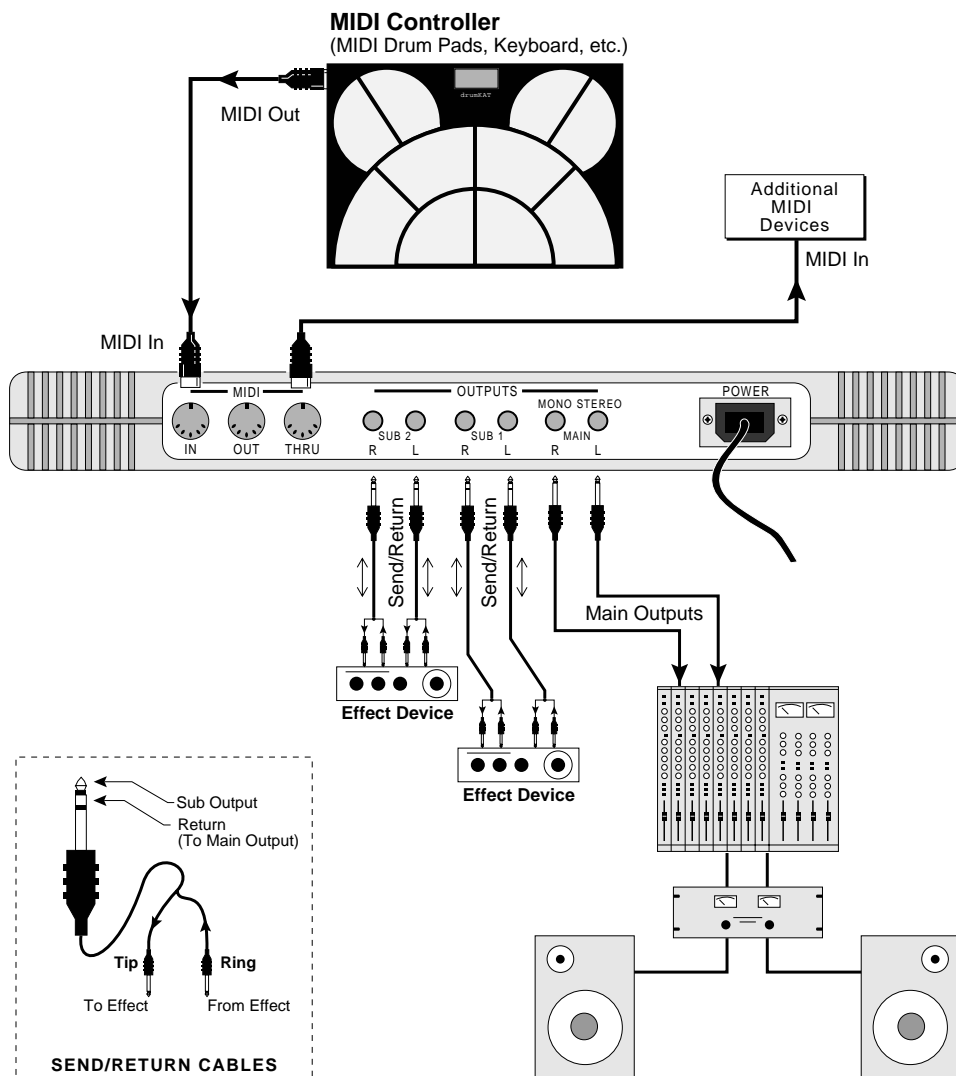

MIDI In - Procussion is controlled by MIDI messages received at the MIDI In connector. Connect the MIDI In of Procussion to the MIDI Out connector of a MIDI controller such as a MIDI percussion controller, or MIDI keyboard.

MIDI Thru - The MIDI Thru jack is used to connect additional MIDI devices onto the MIDI chain. MIDI Thru transmits an exact copy of the messages received at the MIDI In jack.

Outputs - Each of the Sub 1 and Sub 2 output jacks on the Procussion are stereo jacks. The tip of each jack (accessed when a standard phone plug is inserted) connects to the left or right output of that group. If a stereo plug is inserted, the Ring of the stereo plug serves as a signal Return which sums into the Main outputs. See page 13 for additional details.

SETUP #4 FULL ELECTRONIC DRUMKIT

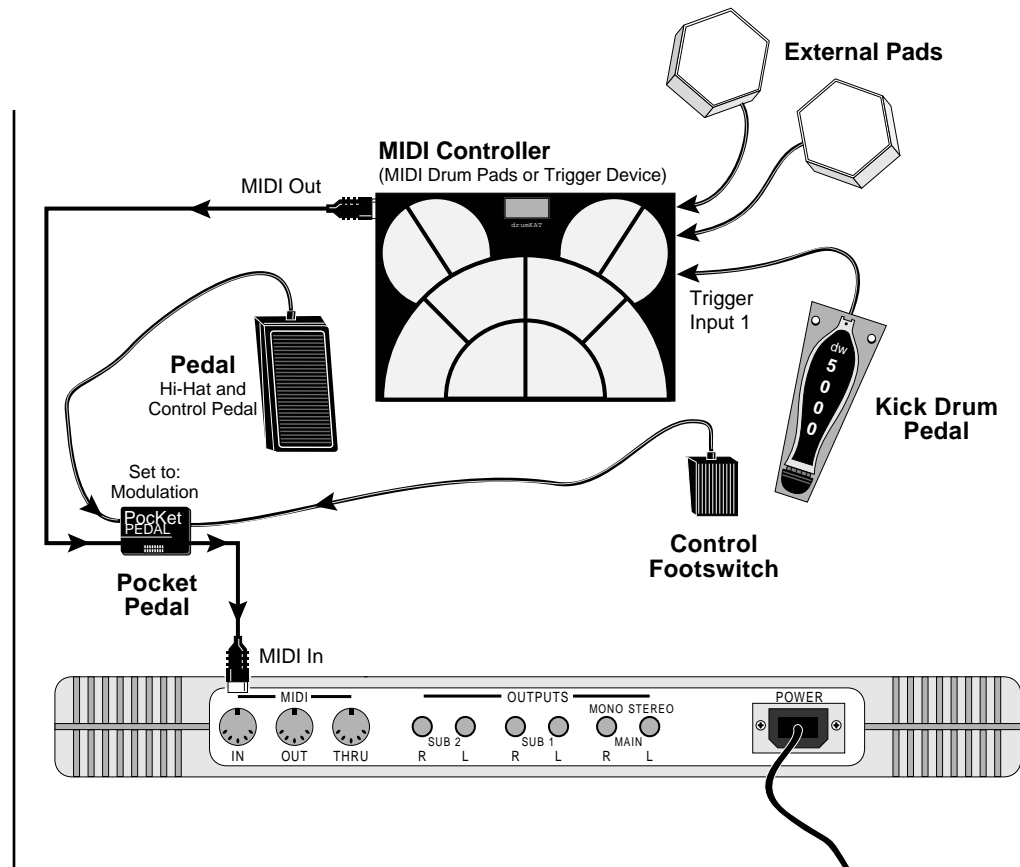

■ Make sure that the velocity response is correctly calibrated on your MIDI Drum Pads.

▼ When using the Anatek Pocket Pedal, the first pedal movement determines the pedal's polarity.

Down 1st = Normal
Up 1st = Reversed

■ The Hi-Hat Pedal corresponds to MIDI key number 52 in the Standard Factory Kit Layouts.

The diagram above shows how to connect the Procussion as a full electronic drum kit containing: a Kick Drum Pedal, Hi-Hat Pedal, MIDI Drum Controller (with 2 external pads) and a Control Footswitch.

Kick Drum Pedal In - In this example, a spring-loaded trigger pedal by Drum Workshop is used. Connect the output of the pedal to Trigger #1 of your MIDI drum pads.

Hi-Hat Pedal In - A standard electronic music voltage pedal functions as a combination Hi-Hat/Control Pedal. In this example, an Anatek Pocket Pedal is used to merge the pedal into the MIDI data. Connect the Footswitch and CV Pedal to the inputs of the Pocket Pedal as shown in the example above. See your dealer about obtaining a suitable control pedal.

MIDI - Connect MIDI Out from your MIDI drum pads to MIDI In of the Pocket Pedal. Connect MIDI Out of the Pocket Pedal to MIDI In of Procussion.

Outputs - Connect the audio outputs to your other equipment as shown in setup procedures 1, 2, and 3.

SUBMIX OUTPUTS

If a stereo plug is inserted into a Sub jack, the Ring of the stereo plug serves as a signal Return which sums into the Main outputs.

Therefore, the Sub 1 and Sub 2 jacks can serve as effect sends and returns in order to further process selected instruments and then return them to the main mix.

The diagram below shows the Sub 1 and Sub 2 jacks being used as send/returns in order to further process selected Procussion instruments without using the effects bus on the mixing board. In a pinch, the effect returns could also be used to sum additional instruments into the main outputs of the Procussion.

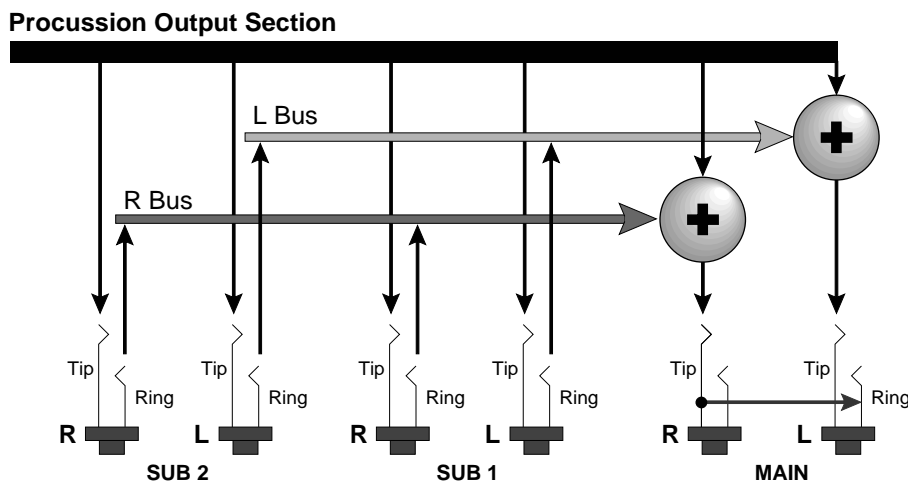

The Sub 1 and Sub 2 jacks can be used as effect returns to the Main Outputs.

POWER UP!

The power switch is located on the left side of the front panel. The Procussion and its MIDI controller may be turned on in any order. When power is applied, the liquid crystal display will light, indicating that the Procussion is operating.

You may have noticed that there is no 110/220 Volt power selector switch on the Procussion.

Procussion automatically switches itself for 110 or 220 Volt operation.

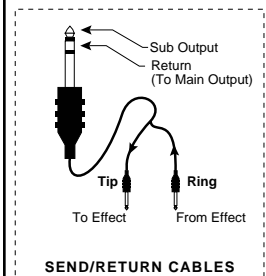

■ Use Send/Return cables as shown above to access the Submix Return points.

BASIC OPERATION

BASIC OPERATION

MAIN CONTROLS

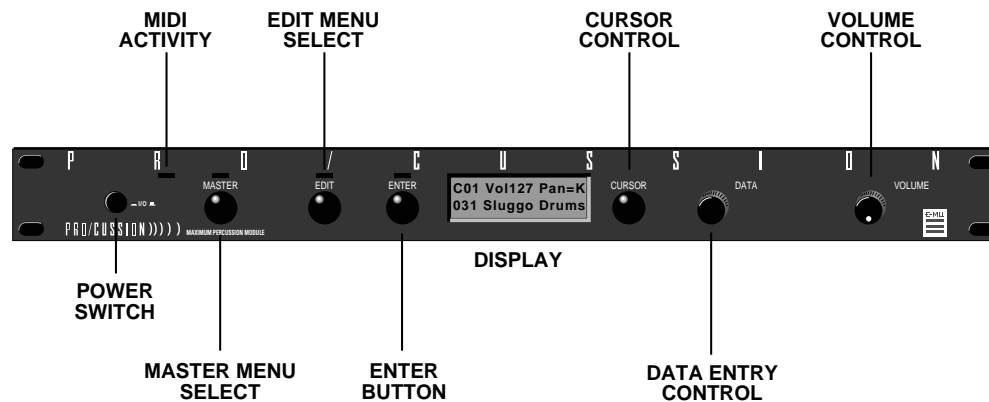

- **Power Switch** - Switches AC power to the Procussion ON and OFF.
- **MIDI Activity LED** - Indicates that MIDI data is being received.
- **Master Menu Select Button** - The *Master* menu contains parameters that affect the entire machine, not just certain Kits. An illuminated LED above the button indicates that you are in the Master menu.
- **Edit Menu Select Button** - The *Edit* menu is used when you want to change parameters of a Kit. An illuminated LED above the button indicates that you are in the Edit menu.
- **Enter Button** - The *Enter* button is used as a “Home” key or to initiate a particular operation within the Procussion. The red LED above the enter button flashes to indicate that the Procussion is waiting for your response.
- **Cursor Control** - This button moves the cursor to the next parameter on the display. (The cursor is a little flashing line underneath one of the parameters in the display.) Press the cursor control repeatedly until the cursor is underneath the desired parameter. The cursor can also be moved bidirectionally using the data entry control while the cursor select button is being held down (i.e. Press and hold the cursor button and turn the data entry knob).
- **Data Entry Control** - The *data entry* control is a stepped, variable control which is used to change parameter values. The control increments or decrements the current value one unit with each click.
- **Volume Control** - This is the master volume control for all audio outputs. Note: For maximum dynamic range, set this control at full level.

BASIC OPERATION

KIT SELECTION

Press the cursor key repeatedly until the cursor is underneath the kit number. (The cursor is a little flashing line underneath one of the parameters in the display.) As the data entry control is rotated, the kit number and name will change. The displayed kit will be assigned to the displayed MIDI channel. Kit numbers range from 000 to 127.

C01 Vol127 Pan=K
000 Kit Name

÷ MIDI Channel Parameters
÷ Kit Information

MIDI CHANNEL SELECTION

Press the cursor key repeatedly until the cursor is underneath the channel number. (The cursor is a little flashing line underneath one of the parameters in the display.) Rotate the data entry control to select MIDI channel 01-16. As the channel is changed, the display will change to show the kit, volume and pan associated with the displayed channel.

C01 Vol127 Pan+0
000 Kit Name

■ If your Procussion is not responding properly or plays the wrong kit, make sure that Procussion and your MIDI controller are set to the same MIDI channel and that the MIDI Volume is turned up.

For more information about MIDI, see MIDI Realtime Controls on page 44.

CHANNEL VOLUME

Press the cursor key repeatedly until the cursor is underneath the volume value. Rotate the data entry control to select volume 00-127. (This is the same parameter as MIDI volume control #7, and changes made over MIDI will be shown in the display.)

CHANNEL PAN

Press the cursor key repeatedly until the cursor is underneath the pan value. Rotate the data entry control to select pan values -7 to +7 or "K". When "K" is selected, the pan value specified in the kit is selected. Any other value will override the pan parameter in the kit. (This is the same parameter as MIDI pan control #10, and changes made over MIDI will be shown in the display.)

■ Channel Pan should normally be set to "K" unless realtime control of panning is desired. This will allow the preprogrammed pan settings for each zone or stack to be used.

BASIC OPERATION

MULTI-TIMBRAL OPERATION

Multi-timbral operation means that the Procussion can play more than one kit at the same time. For example, a MIDI sequencer could be playing one kit while you play along on another. To access multiple kits on different MIDI channels simultaneously, follow these instructions:

1. Set the MIDI mode to MULTI-Mode, using the **MIDI mode** function in the Master menu (page 24).
2. Decide which MIDI channels you wish the Procussion to receive, and turn all other channels OFF using the **MIDI Enable** function in the Master menu (page 26). *Up to 16 channels can be selected simultaneously!*
3. Select the desired kit for each of the MIDI channels you wish the Procussion to receive using the **MIDI Channel/Kit** selection screen (see previous instructions).
4. Procussion will now respond multi-timbrally on the MIDI channels you have specified. The volume and pan position parameters can be adjusted over MIDI (for each MIDI channel) or using the **Cursor** and **Data Entry** control in the **MIDI Channel/Kit** selection screen.

■ Kit numbers for each MIDI channel can also be selected via MIDI program changes. (This is so simple that it is often overlooked.)

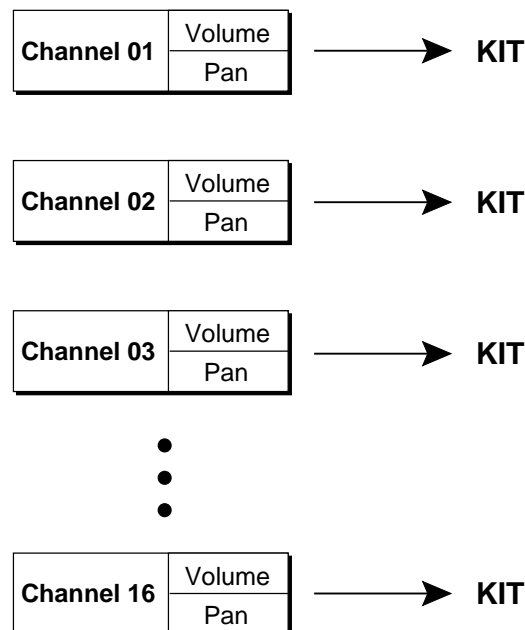

Each of the 16 MIDI channels can be assigned to play a specific kit in Procussion.

MASTER MENU

The Master menu contains functions that affect the overall operation of the Procussion. For example, changing the Master Tune will change the tuning of all the drum kits, not just the one currently displayed.

TO ENABLE THE MASTER MENU

Press the Master key, lighting the LED. The current screen will be the one most recently selected since powering up the Procussion. The cursor will appear underneath the first character of the screen heading on line one.

TO SELECT A NEW SCREEN

Press the cursor key repeatedly (or hold the cursor key while turning the data entry control) until the cursor is underneath the screen title heading. (You may also press the Enter button to return the cursor to "Home" position.) Rotate the data entry control to select another screen.

TO MODIFY A PARAMETER

Press the cursor key repeatedly (or hold the cursor key while turning the data entry control) until the cursor is underneath the parameter value. Rotate the data entry control to change the value.

TO RETURN TO KIT SELECT MODE

Press the Master key, turning off the LED.

MASTER MENU FUNCTIONS

MASTER TUNE

Master Tune adjusts the overall tuning of all kits so that the Procussion may be tuned to other instruments. The master tuning range is ± 1 semitone in 1/64th semitone increments. A master tune setting of "00" would indicate that the Procussion is perfectly tuned to concert pitch (A=440 Hz).

MASTER TUNE +63

MASTER MENU

TRANSPOSE

This function transposes the key of the Procussion in half-step intervals. The transpose range is ± 12 semitones or one octave.



SUBMIX OUTPUTS

The function provides a convenient method of assigning types of instruments a particular output. For example, you might want to direct the kick drum to one of the submix output for external processing. Each zone may be assigned to a particular submix group for each kit (As programmed in the Edit menu). The **Submix Output** function assigns each of the 16 Submixes to a particular output channel or turns the submix Off. The *Submix Output* function selects at which output jack each submix group will appear. The choices are: Main, Sub 1, Sub 1L, Sub 1R, Sub 2, Sub 2L, Sub 2R, or Layer. When Layer is selected, each layer in the stack will be directed to a separate output jack. This function also allows you to change the output assignment of the factory kits.

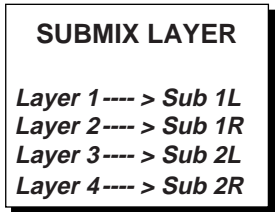
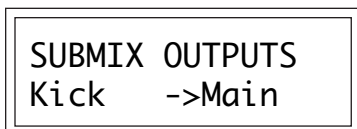

■ If no plugs are inserted into the sub outputs, the audio will be automatically directed to the main outputs.

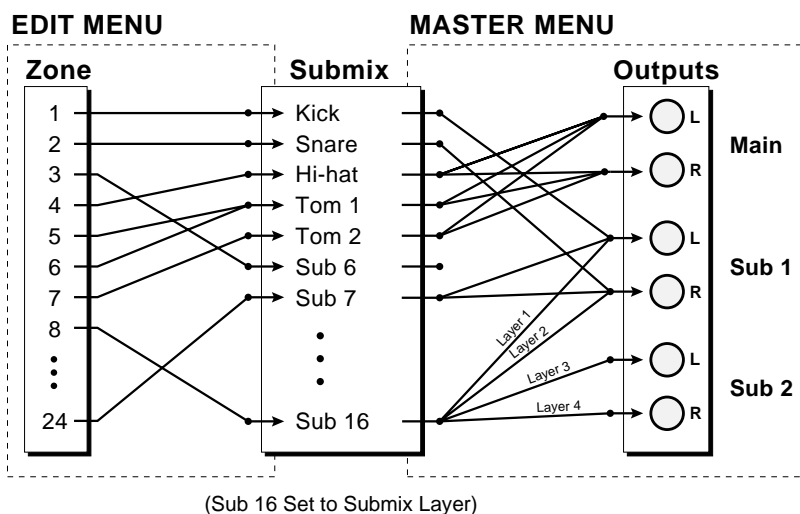

Each zone is assigned to a submix group in the Edit menu. Each submix group is assigned to the output jacks in the Master menu. The Edit menu functions are programmed for each kit. The Master menu functions affect **ALL** kits.

MASTER MENU

MIDI MODE

This function selects one of the four MIDI modes and the MIDI system exclusive ID number.

- **Omni mode** - Procussion responds to note information on all MIDI channels and plays the kit currently displayed in the main screen.
- **Poly mode** - Procussion only responds to note information received on the currently selected MIDI channel (on the kit selection screen) and plays that channel's associated kit.
- **Multi mode** - Procussion responds to data on any combination of MIDI channels and plays the specific kit associated with each of the MIDI channels.
- **ID number** - This function allows an external programming unit to distinguish between multiple Procussion units. When an external programmer is being used, each Procussion should have a different ID number. When transferring SysEx data from one Procussion to another, both units must have the same ID number.

MIDI MODE	ID
Omni	00

GLOBAL VELOCITY CURVE

Incoming velocity data can be modified by a velocity curve in order to provide different types of dynamics in response to your playing or to better adapt to a MIDI controller. This function allows you to select one of the 9 velocity curves or leave the velocity data unaltered (Linear) for each MIDI channel. When "Kit" is selected, the velocity curves selected in the kits are used. For more information on the velocity curves, see page 43.

GLOBAL VEL CURVE
C01 Curve #4

MASTER MENU

GLOBAL TRIGGER TEMPO

Trigger Tempo is a function which generates a control signal based on the tempo of your playing. When your playing tempo exceeds the selected Trigger Tempo, the amount of the control signal begins to increase from zero. This control signal can be used either to switch between drums in a stack or as a general controller which can affect virtually any parameter (set in the Edit menu). For example, Trigger Tempo could be routed to brighten the *Tone* as you play faster. The Global Trigger Tempo can be set to any tempo from 20 BPM (Beats-Per-Minute) to 260 BPM or set to use incoming MIDI clocks as the reference. Alternately, the Trigger Tempo set in each kit may be used (turn data knob all the way counter-clockwise).



ZONE MAPS

This function automatically sets up Procussion to respond to various types of MIDI pad controllers *without* reprogramming the controller. Select the Zone Map for the type of controller you are using. There are preset Zone Maps to match many popular controllers as well as two user definable maps. **If you are using a MIDI keyboard, use the Kit Zone Map.** Zone Maps can be selected for each of the 16 MIDI channels.



Your MIDI Controller assigns each Pad a MIDI Number

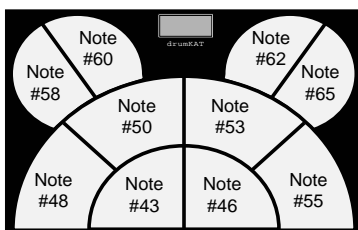

Zone Maps assign MIDI Numbers to Zones

Note #43	----->	Zone 3	= Snare Stack 1
Note #46	----->	Zone 4	= Ambient Snare Stack
Note #48	----->	Zone 11	= Tiny Tom Stack
Note #50	----->	Zone 12	= Med. Tom Stack
Note #53	----->	Zone 13	= Big Tom Stack
Note #55	----->	Zone 14	= Huge Tom Stack
Note #58	----->	Zone 7	= Hi-Hat Stack
Note #60	----->	Zone 17	= Splash Stack
Note #62	----->	Zone 16	= Crash Stack
Note #65	----->	Zone 15	= Ride Stack

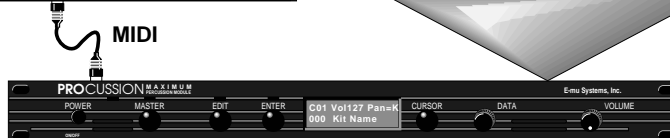

This diagram shows how MIDI key numbers are "mapped" to Procussion Zones.

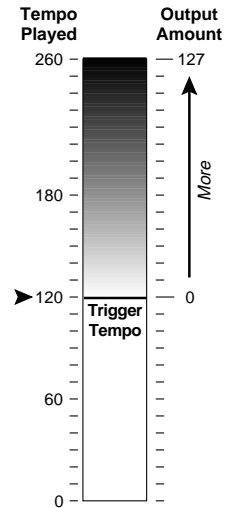

■ When the tempo of your playing exceeds the selected Trigger Tempo, the amount of the control signal increases from zero.

▼ Make sure you are setting the Zone Map for the correct MIDI channel.

■ When using a preprogrammed Zone Map, set your MIDI controller to the following Kit numbers:

- Alesis** - default
- drumKat** - Kit 21
- E-mu SP-12** - default
- Impulse** - default
- Roland Octa I** - Kit A
- Roland Octa II** - Kit 11
- Roland Pad80** - Kit 11
- Roland SPD8** - Kit 1
- Roland R5** - default
- Roland R8** - default

USER ZONE MAP 1 + 2

This function allows you to program the two user definable Zone Maps. The User Zone Maps are useful to route MIDI note data from existing drum machine patterns to the appropriate stacks in Procussion for drum replacement. Each zone may be assigned a MIDI key range. The User Zone Maps are retained in memory when power is removed.

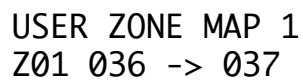

USER ZONE MAP 1
Z01 036 -> 037

DRUM REPLACEMENT WITH THE USER ZONE MAPS

The two User Zone Maps can be used to replace tracks from your drum machine or MIDI sequencer with killer Procussion Stacks.

- 1) Press the Master button on Procussion.
- 2) Turn the data knob until you find the screen:



ZONE MAPS
C01 Kit

- 3) Press the cursor button twice so that the flashing cursor line is underneath the word "Kit". (There may be another word there, but place it underneath the word in the second line, OK?)
- 4) Turn the data knob until the display reads:

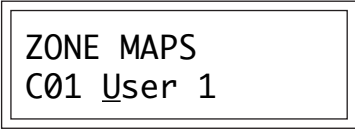

ZONE MAPS
C01 User 1

- 5) Press the Enter button and turn the data knob until the display reads:

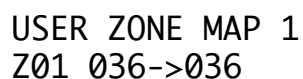

USER ZONE MAP 1
Z01 036->036

- 6) Press the cursor button to move the flashing cursor line to the second line of the display under Z01. Turning the data knob will show you the key numbers which are currently mapped to each zone.
- 7) Assign each of your drum machine buttons to a zone. Place the cursor underneath the key number and press the button on you drum machine to automatically assign the correct number. The chart at the bottom of this page shows which types of Procussion drum sounds will be assigned to each zone. For example, if you want the first button on your drum machine to function as a snare drum, and it is assigned to note number 43, set up the display to look like this:

USER ZONE MAP 1
Z03 043->043

Zones 3-6 are reserved for Snare Drums (see below).

- 8) Continue assigning zones until each button on your drum machine is assigned to a different zone, then press the Master button to exit the module.
- 9) Start the drum machine and verify that the correct types of drums are being played. If the sounds are not assigned as you want them, go back into the "User Zone Map" screen and re-assign them.

The chart below shows how the various types of drums are mapped to the User Zone Maps in the Procussion factory presets.

PROCUSSION FACTORY ZONE ASSIGNMENTS

Zone 1	Kick Drum	Zone 13	Tom
Zone 2	Kick Drum	Zone 14	Tom
Zone 3	Snare Drum	Zone 15	Cymbal
Zone 4	Snare Drum	Zone 16	Cymbal
Zone 5	Snare Drum	Zone 17	Cymbal
Zone 6	Snare Drum	Zone 18	Cymbal
Zone 7	Hi-Hat	Zone 19	Misc. Percussion
Zone 8	Hi-Hat	Zone 20	Misc. Percussion
Zone 9	Hi-Hat	Zone 21	Misc. Percussion
Zone 10	Hi-Hat	Zone 22	Misc. Percussion
Zone 11	Tom	Zone 23	Misc. Percussion
Zone 12	Tom	Zone 24	Misc. Percussion

■ All Procussion kits will not fit into the factory zone assignment scheme so this chart should be used as a basic guide rather than an absolute rule.

MASTER MENU

ENVELOPE MODE

This function allows you to select either a Trigger or Gate mode for each of the 16 MIDI channels when MIDI note on messages are received. For more information on the Envelope Generators, see page 36.

- Trigger mode allows a sound's volume envelope to cycle through all its stages when a note on is received. Trigger mode is almost always used with MIDI drum pads and even when using a MIDI keyboard.
- Gate mode allows a sound's *volume envelope* to cycle through its Attack and Hold stages when a MIDI note on command is received. When the MIDI note off command is received, the Decay phase begins immediately. Gate mode is used when you want the length of the sound to be controlled by how long a key is held.

ENVELOPE MODE
C01 Trigger

MIDI ENABLE

When in MIDI Multi mode, this function lets you turn each MIDI channel On or Off. This is useful when you have other MIDI devices connected and do not want the Procussion to respond to the MIDI channels reserved for the other devices. MIDI Enable only operates when in Multi Mode.

MIDI ENABLE
C01 On

PROGRAM CHANGE

This function lets the Procussion utilize or ignore incoming MIDI program (also called Preset or Kit) change commands for each channel.

PROGRAM CHANGE
C01 On

MASTER MENU

MIDI MODE CHANGE

This function selects whether or not MIDI mode change commands (omni, poly, etc.) are accepted or ignored when received over MIDI (see MIDI Mode).

MIDI MODE CHANGE
 Disabled

MIDI CONTROLLER ASSIGN

The Procussion allows you to assign up to six realtime control sources from your MIDI controller. These control sources could be foot pedals, data sliders or whatever. In this screen, you set up which controllers will be received by Procussion. What effect the controller will have is programmed separately for each Kit. Volume and Pan each have their own controller. Four other MIDI controllers are assigned a letter A-D. Each of the controllers can be assigned to a MIDI realtime controller number from 01-31. The MIDI controller number will be automatically sensed by simply moving the controller (pedal, wheel, etc.) when the cursor is underneath the value. This way you don't have to remember the controller numbers. For more information, see MIDI Realtime Controls in the Programming Basics section.

CONTROLLER#
 VOL:07 PAN:10

Next Screen:

CONTROLLER# ABCD
 01 02 03 04

Some of the standard MIDI Controller numbers are listed below.

- 1 - Modulation Wheel or Lever
- 2 - Breath Controller
- 3 - Pressure: Rev 1 DX7
- 4 - Foot Pedal
- 5 - Portamento Time
- 6 - Data Entry
- 7 - Volume
- 8 - Balance
- 9 - Undefined
- 10 - Pan

MASTER MENU

MIDI FOOTSWITCH ASSIGN

Like the MIDI Controllers, 4 MIDI footswitches can be assigned to MIDI footswitch numbers. Footswitches may be assigned numbers from 64-79. The MIDI footswitch number can be automatically sensed by simply pressing the footswitch when the cursor is underneath the value. Destinations for the footswitch controllers are programmed in the Edit menu.

■ Note that Procussion does not have footswitch inputs on the rear panel. Use the footswitch inputs on your MIDI controller and set Procussion to receive the footswitch commands over MIDI.

FOOTSWITCH#	1234
64	65 66 67

MIDI PROGRAM → KIT

Incoming MIDI program changes can be “mapped” to call a different numbered kit. This is a handy feature when you want a specific program number sent from your controller to be linked with a specific kit on the Procussion. Simply selecting a program on your MIDI controller will automatically call up the proper Procussion kit. Any of the kits in the Procussion may be mapped to any incoming MIDI program change number.

Some of the standard MIDI switch numbers are listed below.

- 64 - Sustain Switch (on/off)
- 65 - Portamento Switch (on/off)
- 66 - Sostenuato (chord hold, on/off)
- 67 - Soft Pedal (on/off)
- 69 - Hold Pedal 2 (on/off)

MIDI PROG	>	KIT
026	>	012

-- Selecting Kit 26 calls up Kit 12

	0	1	2	3	4	5	6	7	8	9
0	00	01	02	03	04	05	06	07	08	09
1	44	191	50	01	15	88	151	78	99	88
2	34	73	106	55	43	75	12	120	121	108
3	30	31	32	33	34	35	36	37	38	39
4	40	41	42	43	44	45	46	47	48	49
5	50	51	52	53	54	55	56	57	58	59
6	60	61	62	63	64	65	66	67	68	69
7	70	71	72	73	74	75	76	77	78	79
8	80	81	82	83	84	85	86	87	88	89
9	90	91	92	93	94	95	96	97	98	99
10	100	101	102	103	104	105	106	107	108	109
11	110	111	112	113	114	115	116	117	118	119
12	120	121	122	123	124	125	126	127		

This chart shows how MIDI program changes can be re-mapped. In this example, program changes 10-29 have been re-mapped. All other programs will be selected normally.

MASTER MENU

AUTO SELECT

When editing a zone or stack parameter, the current zone or stack can be "auto-selected" by simply playing it. While this is a very handy feature, it can sometimes be confusing. Therefore, Auto-Select can be turned On or Off.



REMOTE EDIT

The Remote Edit function allows access to the front panel controls using MIDI note-on events. When Remote Edit is turned On, MIDI key numbers 0-5 activate the following functions.

MIDI NOTE #	FUNCTION
0	Play Current Zone
1	Toggle MASTER menu
2	Toggle EDIT menu
3	Cursor
4	Increment Value
5	Decrement Value

Remote Edit is designed to be used with MIDI drum pads. Create a preset on your MIDI drum pads which assigns the pads to MIDI key numbers 0-5. Now you can program Procussion without putting down your sticks.

Example - To change the stack assigned to a zone using Remote Edit:

- a) Hit pad 2 (Edit) to enter the edit menu.
- b) Hit pad 4 twice (Increment) to move to the stack select screen.
- c) Hit pad 3 twice (Cursor) to move the cursor down to the lower line.
- d) Hit pad 4 (Increment) to increment the stack number.
- e) Hit pad 0 (Play Current Zone) to hear the new stack.
- f) Alternate between steps "d" and "e" until you have the desired stack.



■ **To Record MIDI Data into a Sequencer:**

1. Setup your sequencer to receive system exclusive data.
2. Place sequencer into record mode, then Send Data.

■ **To Receive MIDI Data from a Sequencer:**

1. Simply play back the sequence into Procussion.

▼ *When transferring SysEx data from one Procussion to another, the ID numbers of both units must match.*

SEND MIDI DATA

This function will send MIDI System Exclusive data to the MIDI Out port of Procussion. The MIDI data can either be sent to a computer/sequencer or to another Procussion. Using the cursor key and the data entry control, select the type of MIDI data you wish to transmit. The choices are:

Master Settings: Transmits all parameters in the Master menu except program/kit map and viewing angle. This includes the Kit, Volume, and Pan information for all 16 MIDI channels.

Program/ Kit Map: Transmits only the program/kit map.

User Zone Maps: Transmits user zone maps 1 and 2.

Factory Kits: Transmits all the factory kits.

User Kits: Transmits all the user kits.

Any Individual Kit: Transmits only the selected kit.

The Enter LED will be flashing. Press the Enter button to confirm the operation. To receive MIDI data, simply send the MIDI data into Procussion from another Procussion or your sequencer.

SEND MIDI DATA
024 Industry

VIEWING ANGLE

This function allows you to change the viewing angle of the display so that it may be easily read from either above or below. The angle is adjustable from +7 to -8. Positive values will make the display easier to read when viewed from above. Negative values make the display easier to read from below.

VIEWING ANGLE
+7

DEMO SEQUENCE

Procussion contains a play-only sequencer in order to give you some idea of what is possible using this amazing machine. Press the cursor switch to move the cursor to the bottom line of the display. The Enter LED will begin flashing. Press the Enter switch to start the sequence. The Enter LED will be lit and the bottom line of the display will change to "Stop". Pressing the Enter button again will stop the sequence.

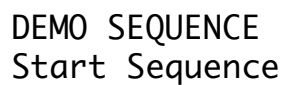

DEMO SEQUENCE
Start Sequence

about **PROCUSSION**

Procussion utilizes digital recordings of real percussion instruments for the basis of its sound. This is similar to a tape recorder except that in the Procussion, the sounds are permanently recorded on digital memory chips.

To perform this modern miracle, sounds and instrument waveforms are first sampled into the Emulator III, our top of the line, 16 bit stereo digital sampler. After the sounds and waveforms have been truncated, looped and processed, they are “masked” into the Procussion ROM (Read Only Memory) chips.

Conceptually, the sampling process is very simple, as shown in the Basic Sampling System diagram. As a sound wave strikes the diaphragm of a microphone, a corresponding voltage is generated. To sample the sound, the voltage level is repeatedly measured at a very high rate and the voltage measurements are stored in memory. To play the sound back, the numbers are read back out of memory, converted back into voltages, then amplified and fed to a speaker which converts the voltage back into sound waves. Of course, playing back 32 channels at different pitches tends to complicate matters, but this is basically how it works. In Procussion, we have left out the Analog/Digital converter stage since the sounds are already sampled for you.

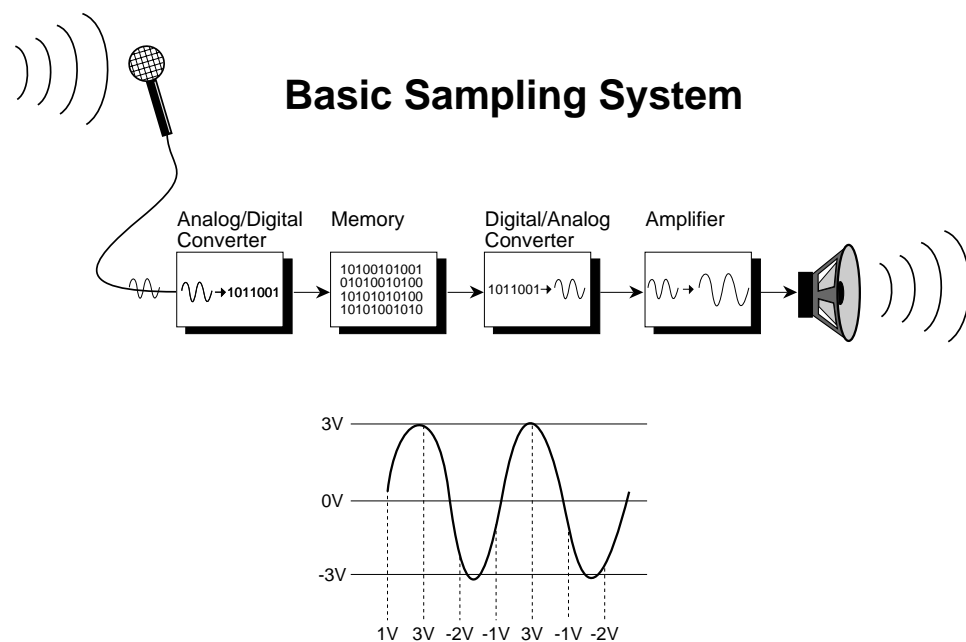

PROGRAMMING BASICS

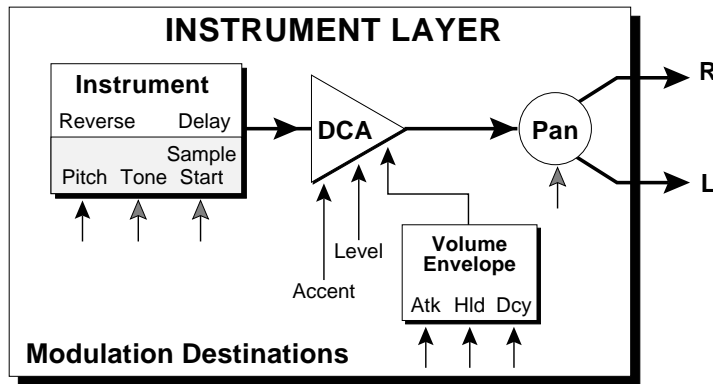

INSTRUMENT LAYER BLOCK DIAGRAM

The diagram above shows the basic architecture of a single instrument layer. The large, horizontal lines and arrows show the audio signal path. The small vertical arrows indicate parameters which can be modulated.

The **Instrument** is one of the 221 sampled percussion sounds stored in ROM. The instrument can be reversed or delayed and the pitch, tone and sample start point can be modulated as shown by the small arrows.

Following the signal path, the sound passes through a **DCA** (Digitally Controlled Amplifier) which controls the volume of the instrument. In addition to Volume and Accent modulation, a **Volume Envelope Generator** can control the DCA in order to shape the volume of the instrument over the course of the note.

Lastly, the sound reaches the **Panning Network**, which positions the instrument in the stereo field.

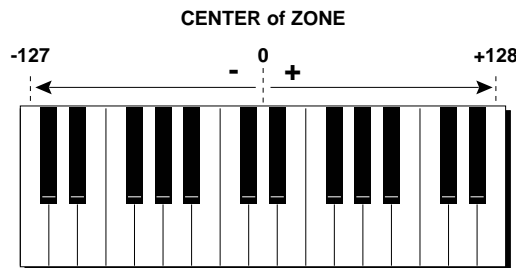

KEY NUMBER

Key Number is a value generated at the start of the note which varies according to which key is played. The center of the zone acts as a zero reference (no effect at the center) and increases in the positive and negative direction as shown above. The end keys of the zone are always the maximum values (-127, +128), but these can be scaled in the patch.

PROGRAMMING BASICS

Modulation Sources:

Velocity
 Key Number
 Trigger Tempo (Rate)
 Random
 MIDI Control A/B/C/D
 Pressure
 Pitch Wheel
 LFO

Destinations:

Pitch, Pitch 1/2/3/4
 Volume, Volume 1/2/3/4
 Accent, Accent 1/2/3/4
 Attack, Attack 1/2/3/4
 Hold, Hold 1/2/3/4
 Decay, Decay 1/2/3/4
 Pitch Env. Amount
 Pitch Env. Amt 1/2/3/4
 Pitch Env. Decay
 Pitch Env. Dcy 1/2/3/4
 Pan, Pan 1/2/3/4
 Tone, Tone 1/2/3/4
 Sample Start
 Sample Start 1/2/3/4
 LFO Rate, LFO Amount

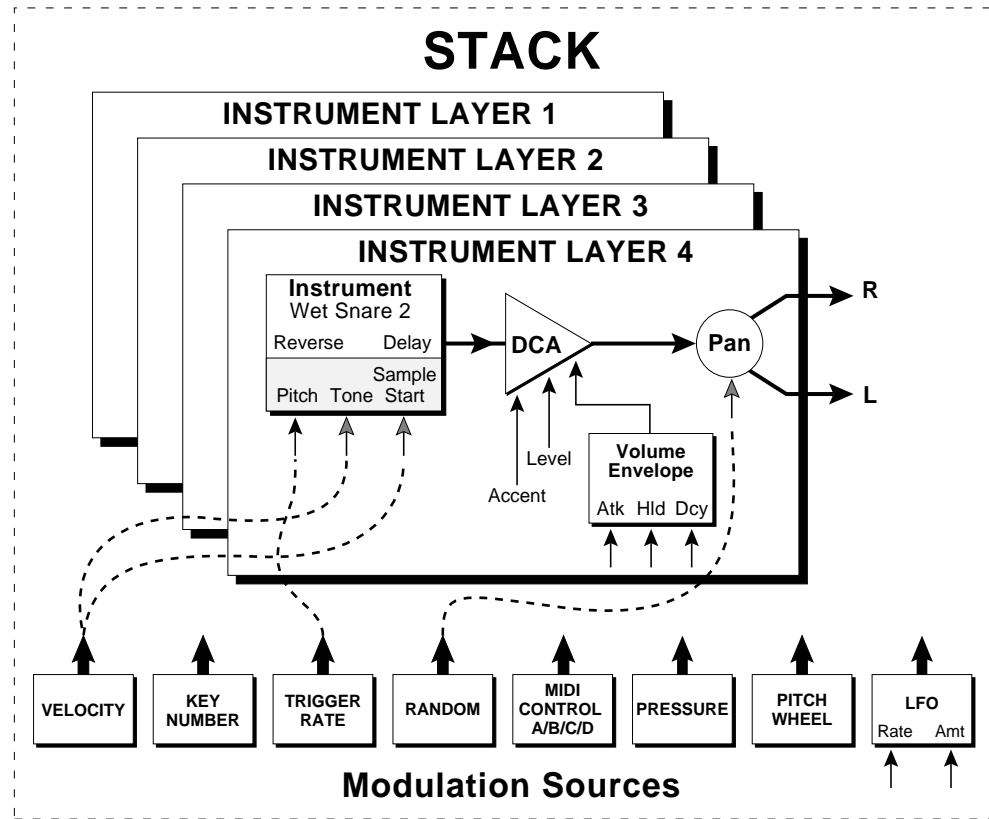

STACK BLOCK DIAGRAM

The diagram above shows the organization of a Procussion Stack. You can think of a stack as a single sound, although it can be made up of up to four different instruments. "Stacking" instruments, in combination with the various modulation parameters can create almost unlimited variations in the final sound.

■ Drum Kits may be assembled using the factory stacks or by creating your own custom stacks. There are 8 custom stacks for each kit in Procussion.

At the stack level, a modulation source can control up to four destinations or one destination can be controlled by up to four sources. The modulation sources can be applied to an individual instrument layer or all four layers simultaneously. The possible modulation routings are completely flexible as shown in the example above.

Three of the modulation destinations, Tone, Sample Start, and Pan cannot be dynamically varied during the course of the note. Their value is "locked in" at the start of the sound. All the other destinations marked with black arrows can be dynamically varied over time.

PROGRAMMING BASICS

VELOCITY CURVES

Incoming velocity values can be scaled by one of the 10 velocity curves in order to match your playing style or better adapt to the MIDI controller. Selecting "Linear" leaves the velocity data unaltered and "Constant" always outputs the maximum value of 127. The velocity curve can be selected globally (for all kits) for each MIDI channel (Master menu), or be programmed separately for each individual kit. Experiment with the curves to find the one that works best for your style and MIDI controller.

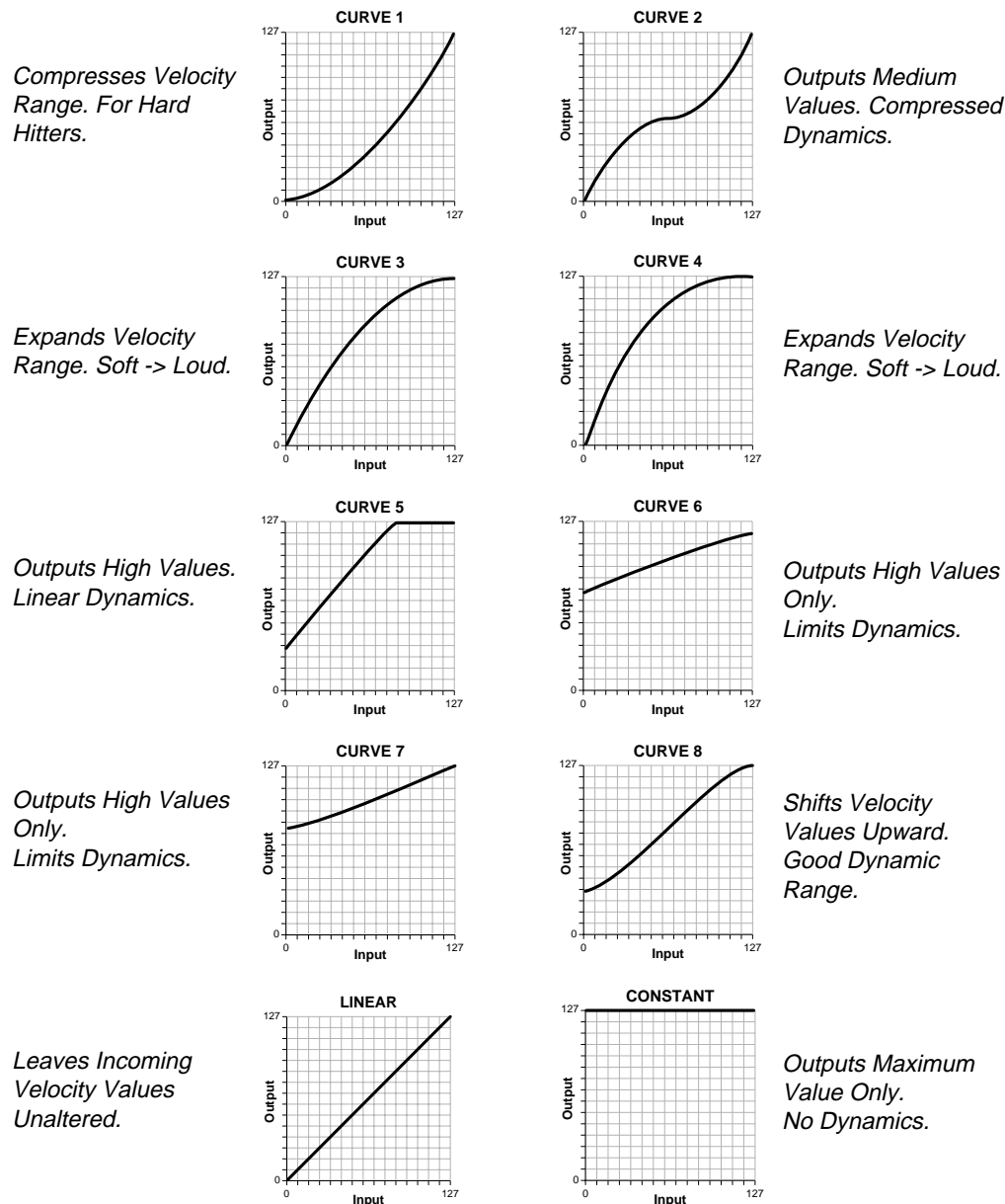

PROGRAMMING BASICS

MIDI REALTIME CONTROLS

The MIDI realtime controllers may seem confusing at first, but they are really very simple to understand. You probably already know that there are 16 MIDI channels that can be used. Each of the 16 MIDI channels uses 3 basic types of messages; *note on/off*, *program changes*, and *continuous controller* messages. Your MIDI keyboard or MIDI drum pads, in addition to telling Procussion which note was played, may also send *realtime control* information, which simply means occurring in real time or live. (You may be using a MIDI device other than a keyboard, but for simplicity's sake we'll presume that you're using a keyboard.) Realtime control sources include such things as pitch wheels or levers, modulation wheels or levers, control pedals, aftertouch, etc. and are used to add more expression or control. Your MIDI keyboard sends out realtime controller information on separate channels called *continuous controller channels*. There is a set of 32 continuous controller channels for each of the 16 MIDI channels. Some of the controller channels, such as pitch wheel, volume, and pan have been standardized. For example, volume is usually sent on continuous controller channel #7.

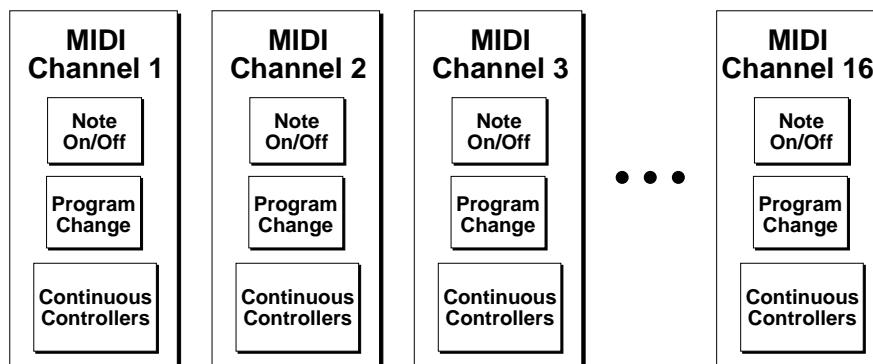

Common realtime controllers such as the pitch wheel, volume, pan and pressure are pre-programmed to their proper destinations. Your keyboard may have other realtime controls such as a control pedal or data slider which can also be programmed to control most of the parameters on Procussion.

The Procussion is equipped with a sophisticated *MidiPatch*[™] system, which allows you to route any continuous controller to any realtime modulation destination. The *MidiPatch* system is also very easy to use. First, you must know which controller numbers your keyboard or pad setup can transmit.

PROGRAMMING BASICS

Let's say for instance, that you are using a Yamaha DX7 as your master keyboard. The DX has pitch and modulation wheels, a breath controller, a data slider and a foot pedal, all of which transmit their values over MIDI. The standard MIDI controller numbers for the controls are listed below (the pitch wheel has a dedicated controller, PWH). First, we would go to the Master menu, MIDI Controller Assign and define the 4 MIDI controllers that we wish to use. Assign each controller number to one of the letters A-B-C-D.

- 01 - Modulation Wheel A
- 02 - Breath Controller B
- 04 - Foot Pedal C
- 06 - Data Entry D

To complete the connections for a particular kit, go to the Edit menu, Realtime Control, and route the MIDI A, B, C, D to the desired destinations. These could be patched to any 4 destinations or even to the same destination. The MIDI Controller Amount menu, (in the Edit menu) allows you to scale the amounts of each of the controllers by a positive or negative value. The signal flow is shown in the diagram below.

- Standard MIDI Controller Numbers:**
- 1- Modulation Wheel
 - 2- Breath Controller
 - 3- Pressure Rev 1 DX7
 - 4- Foot Pedal
 - 5- Portamento Time
 - 6- Data Entry
 - 7- Volume
 - 8- Balance
 - 9- Undefined
 - 10- Pan

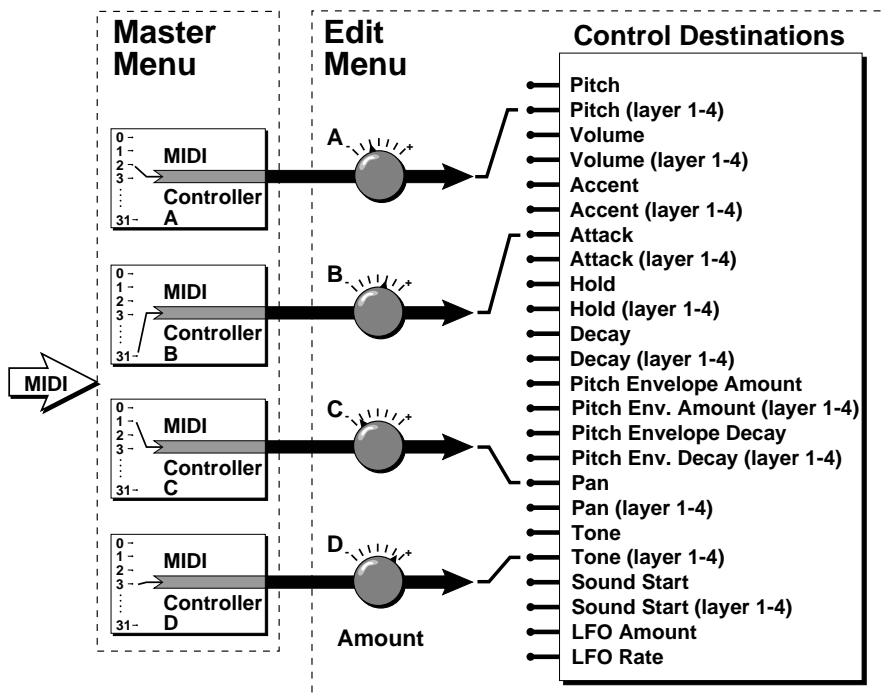

The MIDI controllers A-B-C-D must have both a source (0-31), and a control destination assigned.

PROGRAMMING BASICS

STEREO MIX OUTPUTS

Procussion has three sets of polyphonic stereo outputs (Main, Sub 1, Sub 2). Each zone in a particular kit may be directed to appear at any of these three stereo outputs. This feature is useful for signal processing (EQ, reverb, etc.) of individual sounds prior to final mixdown.

Each zone in a kit can be assigned to one of the submix groups. In general, all the kick drums will be assigned to "Kick", snare drums to "Snare", and so on.

Suppose you wanted to add heavy reverb just to the snare drum. Simply go into the Master menu, Submix Outputs and assign Snare to a particular output. The snare drum will now be directed to that output for processing, regardless of what kit you are using.

Note: All kits will be automatically routed to the Main outputs unless plugs are inserted into the Sub 1 or Sub 2 outputs.

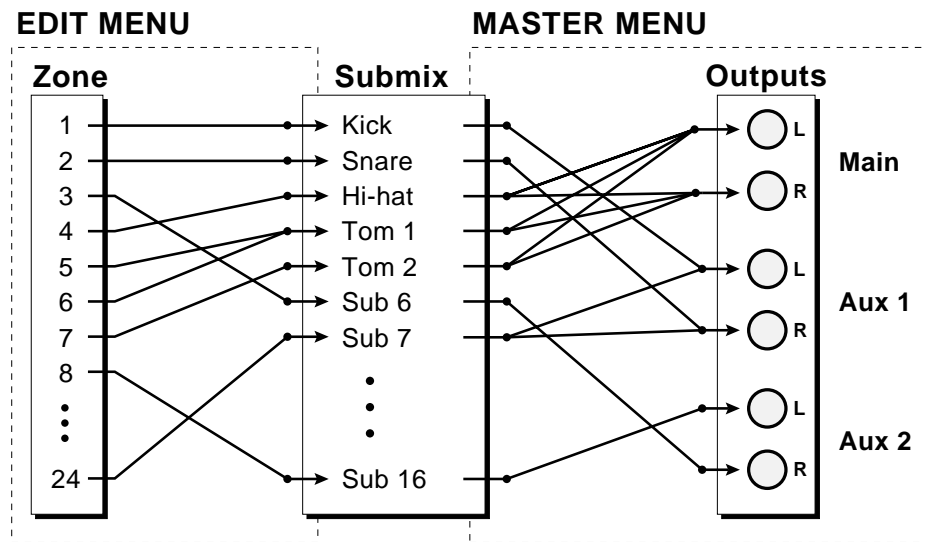

The Edit menu zone assignments are made for each particular kit, while the Master menu output assignments apply to all kits.

PROGRAMMING BASICS

PROGRAMMING BASICS

Your initial involvement with the Procussion will most likely consist of using the existing kits and selecting MIDI channels. While the factory kits are very good, there are probably some things you would like to change, perhaps the tuning, or the tone of a stack. You may also want to make your own custom kits using complex modulation routings. Entirely new sounds can be created by combining the attack portion of one sound with the body of another sound or by combining the digital waveforms with sampled sounds. There are 64 user locations (64-127) available to store your own creations or edited factory kits. Best of all, it's easy to edit or create new kits using the edit menu.

Creating your own custom kit is easy. First, you select the key range for a zone. Then you can simply select the desired stack from the palette of pre-programmed factory stacks. Repeat these two steps until you have a large enough drum kit. You may assign up to 24 stacks to a kit and a zone may contain up to 4 instruments. MIDI drum pads may be programmed to trigger successive note numbers within a given zone for easy tuned percussion.

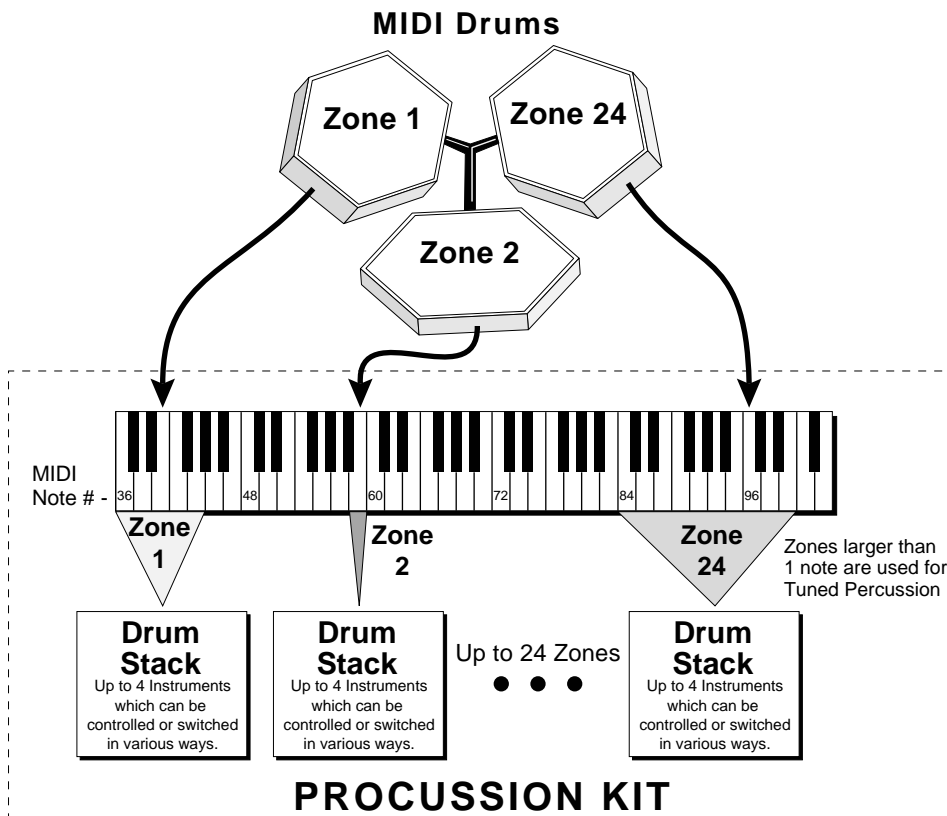

PROGRAMMING BASICS

Procussion has an extensive modulation implementation using multi-wave LFO's (Low Frequency Oscillators), envelope generators and the ability to respond to multiple MIDI controllers. You can simultaneously route any combination of these control sources to multiple destinations.

MODULATION

Modulation means to *dynamically change* a parameter, whether it be the volume (amplitude modulation), the pitch (frequency modulation), or whatever. Turning the volume control on your home stereo rapidly back and forth would be an example of amplitude modulation. To modulate something we need a modulation *source* and a modulation *destination*. The source is your hand turning the knob, and the destination is the volume control. If we had a device that would automatically turn the volume control, we would also call that device a modulation source. The Procussion is designed so that for each of the variable parameters, such as the volume, there is an initial setting which can be changed by a modulation source. Therefore in the case of volume, we have an initial volume and we can change or modulate that volume with a modulation source. Two main types of modulation sources on the Procussion are *Envelope Generators* and *Low Frequency Oscillators*. In the example above, an envelope generator could be routed to automatically turn the volume control as programmed by the envelope. Or, a low frequency oscillator could be routed to automatically turn the volume control up and down in a repeating fashion.

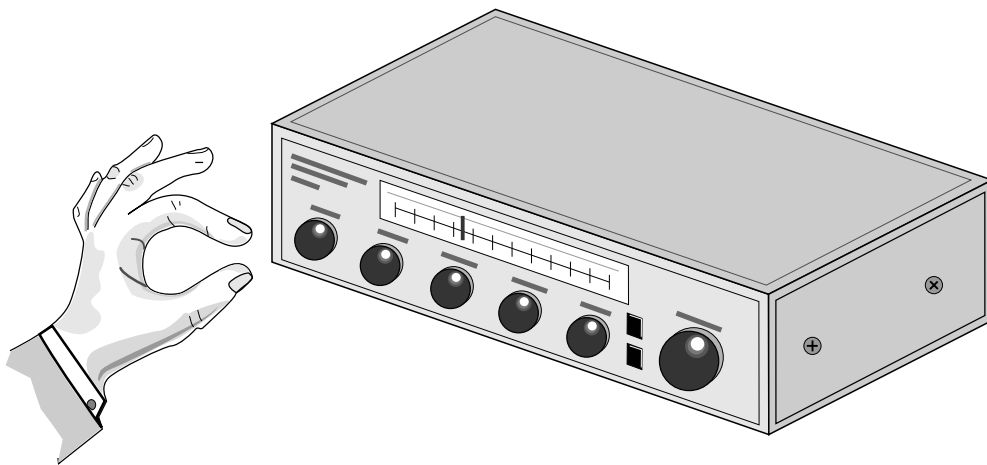

Turning the volume control back and forth on your home stereo is an example of Amplitude Modulation.

PROGRAMMING BASICS

MODULATION SOURCES

Procussion has several different types of modulation sources, including:

■ MODULATION SOURCES

Velocity - How hard the key or pad is played.

Key Number - Generates a value at the start of the note. Outputs a value of zero at the center of the zone's range and increases in the positive (+) direction as keys are played up the scale and in the negative (-) direction as keys are played down the scale.

Trigger Tempo - A value which increases as the playing tempo increases beyond a programmed threshold.

Random - Generates a random value at the start of the note.

MIDI Controllers A/B/C/D (4) - Any type of MIDI controller data.

Keyboard Pressure (mono aftertouch) - Key pressure applied after the key is initially pressed.

Pitch Wheel - A synthesizer pitch bend wheel.

Low Frequency Oscillator - Generates repeating waves.

Envelope Generator - Generates a programmable "contour" which changes over time when a note is played.

■ FOOTSWITCH MODULATION SOURCES

Changes a parameter when one of the three MIDI footswitches are pressed. The footswitches can be programmed to switch: Sustain (Layers 1, 2, 3, 4 or All), Alternate Volume Envelope (Layers 1, 2, 3, 4 or All), Alternate Volume Release (Layers 1, 2, 3, 4 or All), or Reverse the Sound (Layers 1, 2, 3, 4 or All).

Note that the Procussion does not have actual footswitch input jacks. Your MIDI controller (keyboard, MIDI drum pads, etc.) should have footswitch input jacks and be able to send MIDI footswitch commands.

PROGRAMMING BASICS

■ Each Instrument has its own factory preset AHD envelope which is normally employed. If a programmable volume envelope is desired, the alternate envelope is used.

ENVELOPE GENERATORS

An envelope can be described as a “contour” which can be used to shape the sound in some way over time. Each channel of the Procussion contains two envelope generators. One of the envelope generators, the Alternate Volume Envelope, controls the volume of each instrument and has 3 stages, Attack, Hold and Decay. The other envelope, the Pitch Envelope, is permanently routed to control the pitch of an instrument and has only one stage, Decay.

There are two envelope modes on Proformance: Trigger Mode (most often used with drum pads) and Gate Mode (most often used with a keyboard). In Trigger mode, the envelope always completes the Attack-Hold-Decay stages, regardless of how long the key was held down. In Gate Mode, the envelope follows the Attack and Hold phases only as long as a key is pressed and held. At any time the key is released, the Decay phase begins. The Envelope parameters can be described as follows:

■ **Attack** - The time it takes to go from zero to the peak (full) level.

■ **Hold** - The time the envelope will stay at the peak level before starting the decay phase. If a footswitch is being used to control Sustain, the envelope will remain in this stage as long as the footswitch is pressed.

■ **Decay** - The time it takes the envelope to fall to the zero level after the key is released or the hold time has elapsed (in trigger mode).

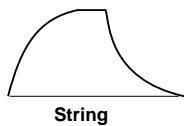
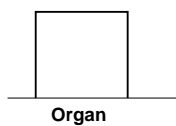
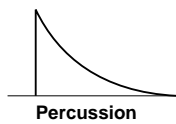

■ These are generalized volume envelopes of a few types of sounds.

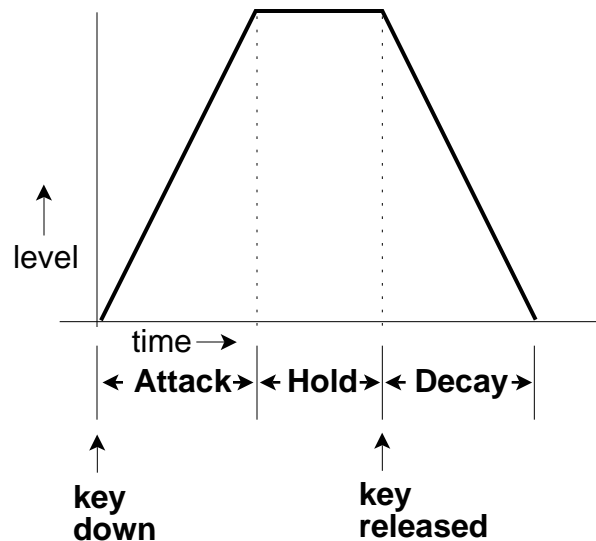

PROGRAMMING BASICS

LOW FREQUENCY OSCILLATORS (LFOs)

A Low Frequency Oscillator is simply a wave which repeats at a slow rate. Procussion has two multi-wave LFOs for each percussion stack. The LFO waveforms are: Triangle, Sine, Sawtooth and Square.

By examining the diagram of the LFO waveforms, you can see how the LFO will affect a modulation destination. Suppose we are modulating the pitch of an instrument. The sine wave looks smooth, and will smoothly change the pitch. The square wave changes abruptly, and will abruptly change the pitch from one pitch to another. The sawtooth wave smoothly increases, then abruptly changes back down. The sound's pitch will follow the same course. Controlling the pitch of an instrument is an easy way to hear the effects of the LFO waves.

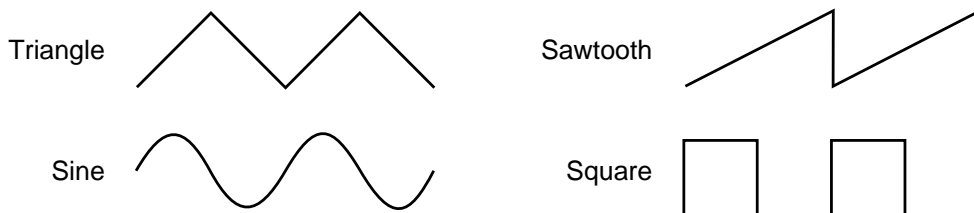

When the amount of an LFO is a negative value, the LFO shape will be inverted. For example, inverting the sawtooth wave produces a wave that smoothly decreases, then instantly resets up.

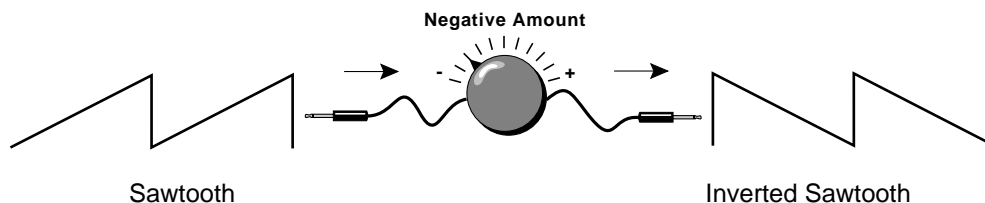

PROGRAMMING BASICS

MODULATION PATCHES

Connecting a modulation source to a destination is called a *patch*. Procussion lets you connect the modulation sources in almost any possible way to the modulation destinations. Each patch also has an amount parameter which determines “how much” modulation is applied to the destination. The modulation amount can be positive or negative and will either add or subtract from the initial value. Modulation sources can be simultaneously patched to any 4 of the 57 destinations for each stack.

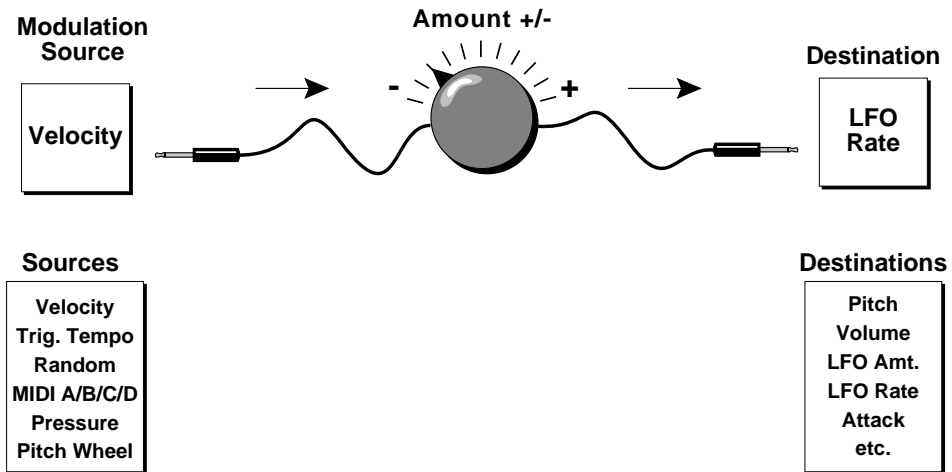

In the example above, Velocity (or how hard a key or pad is played) is "Patched" to control the LFO rate. Since the modulation amount is negative, the harder the note is played, the slower the LFO rate. If the modulation amount was set to a positive value, the LFO rate would increase, the harder the key was played.

ACCENT AND VOLUME

Accent and Volume both control loudness, but behave in a slightly different way when they are modulated. Volume can be modulated between zero and the maximum initial programmed level. When Accent is modulated, it *adds* to the initial level.

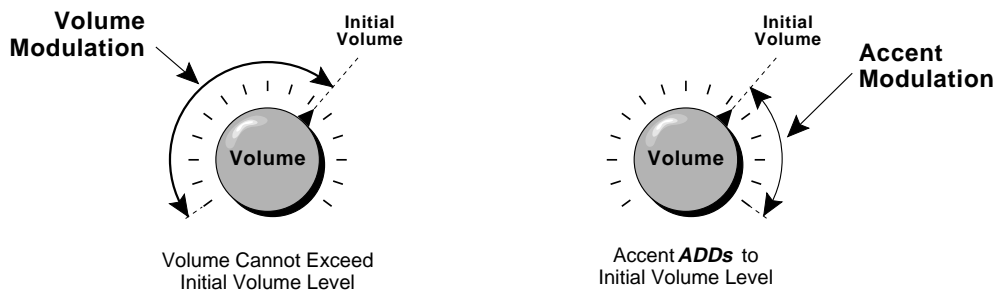

EDIT MENU

```
PITCH ENV  S1L1
On   D23 AMT+255
```

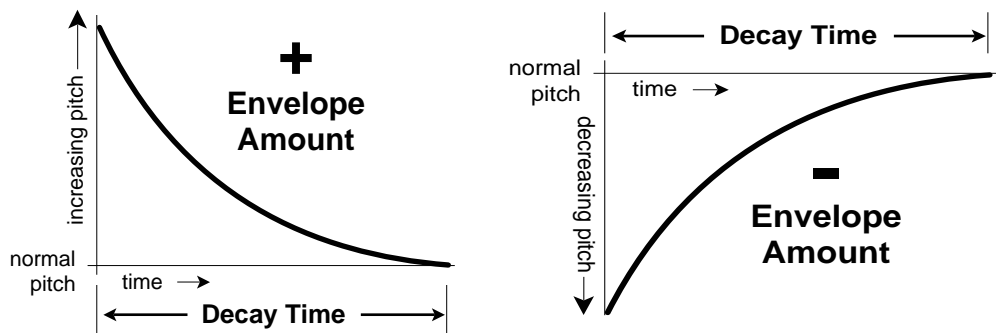

A positive envelope amount setting will sweep the pitch downward and a negative setting will sweep the pitch upward.

LOW FREQUENCY OSCILLATOR

This screen controls the Waveshape, Rate, Amount and Destination of the LFO. There is one LFO per stack which can be routed to the *Pitch* of layers 1, 2, 3, 4 or all, or *Volume* of layers 1, 2, 3, 4 or all. (If a parameter is not labeled 1, 2, 3, or 4 it affects all.) The LFO can be used to produce vibrato (when routed to pitch), or tremolo (when routed to control volume). The four LFO waveshapes are: Triangle, Sine, Sawtooth, and Square. The amount can be varied from -128 to +127. Negative values will produce inverted waveshapes.

```
LFO Tri  R36  S1
->Off   AMT+016
```

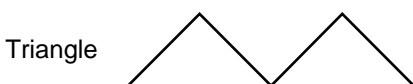

■ Since the LFO always starts from the beginning of its cycle at the start of a note, it can be used as an extra envelope generator when set to a slow rate.

EDIT MENU

STACK MODULATION CONTROL

These functions allow you to route modulation sources to any of the destinations in the eight custom stacks. Up to 4 simultaneous patches may be programmed (3-6). For each of the modulation patches, there is a *Modulation Source*, a *Modulation Destination*, and an *Amount* parameter. The amount parameter is variable from -128 to +127. **Place the cursor under the appropriate parameter and change the Patch Number, User Stack Number, Modulation Source, Modulation Destination, and the Amount using the data entry control.** If a modulation destination is not labeled with a layer number, it affects all layers.

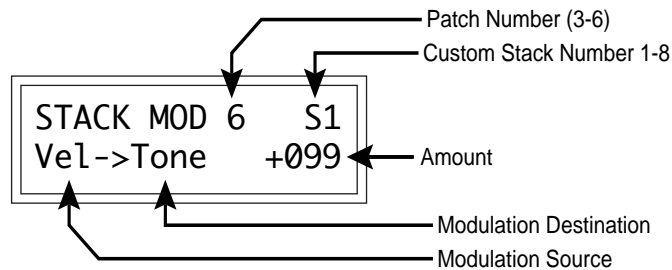

Modulation Sources:

- Velocity
- Key Number
- Trigger Tempo (Rate)
- Random
- MIDI Control A/B/C/D
- Pressure
- Pitch Wheel
- LFO

Destinations:

- Pitch, Pitch 1/2/3/4
- Volume, Volume 1/2/3/4
- Accent, Accent 1/2/3/4
- Attack, Attack 1/2/3/4
- Hold, Hold 1/2/3/4
- Decay, Decay 1/2/3/4
- Pitch Env. Amount
- Pitch Env. Amt 1/2/3/4
- Pitch Env. Decay
- Pitch Env. Dcy 1/2/3/4
- Pan, Pan 1/2/3/4
- Tone, Tone 1/2/3/4
- Sample Start
- Sample Start 1/2/3/4
- LFO Rate, LFO Amount

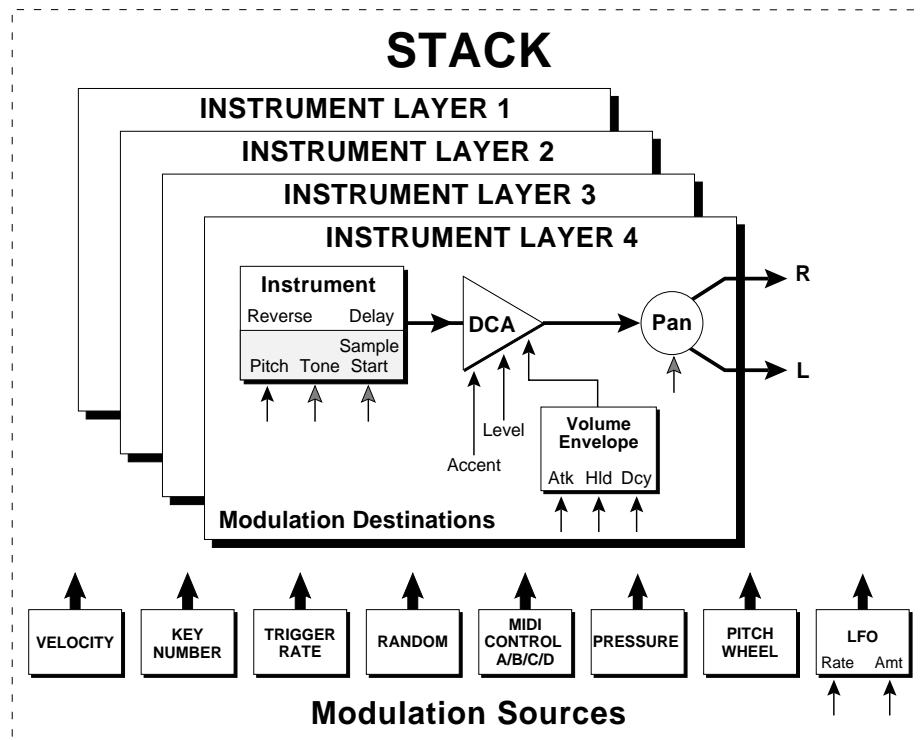

EDIT MENU

STACK FOOTSWITCH 3 AND 4

This function allows you to route the two stack level footswitches (3 and 4) to any of the footswitch destinations for each of the 8 custom stacks. The footswitches can be routed to switch: Sustain (Layers 1/2/3/4 or All), Alternate Volume Envelope (Layers 1/2/3/4 or All), or Reverse Sound (Layers 1/2/3/4 or All).



■ There are 8 Custom Stacks for **each** Kit.

SWITCH MODE

The Super-Switch feature allows a control input (velocity, a control pedal, trigger rate, etc.) to determine which stack layer(s) will be heard. This function selects the switch mode for each of the 8 custom stacks.

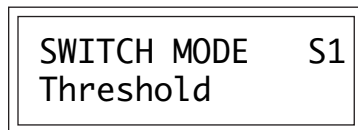

OFF

All layers within the stack are played at their programmed volumes. The control input is ignored.

CROSSFADE

The control input determines the relative volumes of the layers. As the control input is increased, layer 1 will crossfade into layer 2, layer 2 will crossfade into layer 3, then layer 3 will crossfade into layer 4. Unassigned layers will not be included in the level calculation.

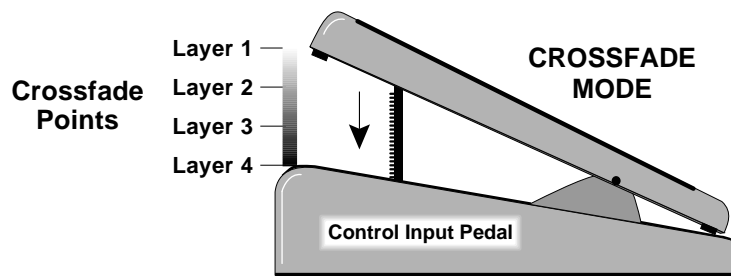

In this example, a control pedal feeds the control input. When the pedal is fully up, only layer 1 will play. As the pedal is moved down, layer 2 will be faded in as layer 1 is faded out. Next, layer 3 will fade in as layer 2 is faded out. Finally, layer 4 will fade in as layer 3 is faded out.

■ Note that other modulation sources (Velocity, Trigger Rate, Random, etc.) besides a pedal may be used to control switch mode. Velocity is commonly used to switch between different layers as the drum pad is struck harder.

EDIT MENU

THRESHOLD If the control input is between 0 and switch point 1, then layer 1 will be played. If the control input is between switch points 1 and 2, then layer 2 will be played. Likewise for layers 3 and 4.

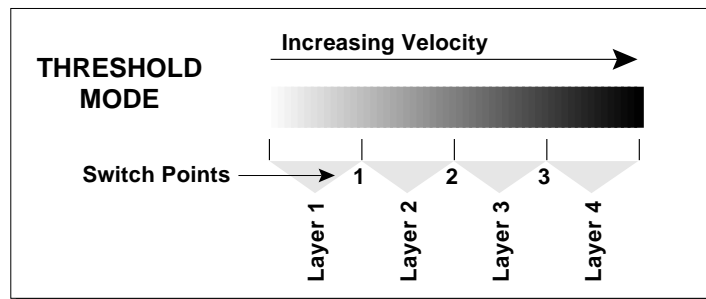

In this example velocity feeds the control input. When the velocity value is below the first switch point, only layer 1 will play. When the velocity value is between switch points 1 and 2, only layer 2 will be played. When the velocity value is between switch points 2 and 3, only layer 3 will be played. When the velocity exceeds switch point 3, only layer 4 will play.

▼ Only ONE hi-hat zone is allowed per kit (low-number priority). If other zones are set to hi-hat mode, they will simply behave as if in threshold mode.

■ Instruments 45-54 are particularly useful with Hi-Hat mode. Use Mono assignment mode for the most realistic effect.

▼ Only controller A, B, C or D can be used as the control source when in hi-hat mode. If another source is selected, it will revert to threshold mode behavior.

HI-HAT This mode is similar to Threshold mode in the first 3 layers, but simulates an actual Hi-Hat pedal in that layer 4 is only triggered when the control input crosses points 2 and 3 and is equal or greater than switch point 3. The control source must be controller A, B, C, or D.

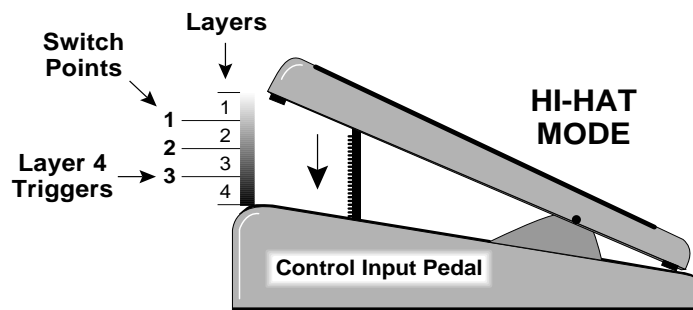

ALTERNATE 1 If the control input is *less* than switch point 1, then layer 1 will be played. Otherwise, a layer will be selected in a cyclical manner.

ALTERNATE 2 If the control input is *greater* than switch point 1, then layer 1 will be played. Otherwise, a layer will be selected in a cyclical manner.

EDIT MENU

RANDOM 1 If the control input is *less* than switch point 1, then layer 1 will be played. Otherwise, a layer will be selected at random.

RANDOM 2 If the control input is *greater* than switch point 1, then layer 1 will be played. Otherwise, a layer will be selected at random.

SWITCH GROUP

This function operates together with Switch Mode and selects either 4-way switching (1/2/3/4) or 2-way switching (1+2/3+4) for each of the 8 custom stacks. If a given stack does not have an instrument assigned, it will not be used. Only the first switch point is used in 2-way switching. In 2-way switching, layers 1 and 2 will play when the switch source is below switch point 1. When the switch source exceeds switch point 1, layers 3 and 4 will play.

SWITCH GROUP S1 1/2/3/4

SWITCH SOURCE

This function selects the control input for switch mode. The control input can be:

	Layer switches depending on:
Velocity -----	How hard a pad or key is played.
Trigger Rate -----	How fast a pad or key is played.
Random Number -----	A random number.
Controller A/B/C/D ---	The position of a MIDI controller.
Footswitch 1/2/3/4 -----	The position of a footswitch.

The footswitches generate a value of 127 when depressed.

SWITCH SOURCE S1 Velocity

EDIT MENU

SWITCH POINTS

This function selects the control input switch points used in *Switch Mode* (for each of the 8 custom stacks).

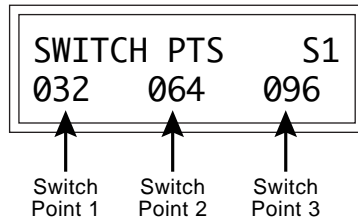

AUDITION LAYER

When Audition Layer is turned on, only the selected layer will be heard. This function is useful when editing a specific layer in a stack.

▼ Remember to turn Audition Layer Off when you are finished auditioning.

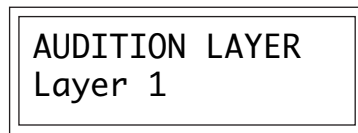

COPY ZONE

This function allows you to copy a zone from any kit, and place it in any zone location of the currently selected kit.

To Copy a Zone:

- 1) First select the kit containing the zone you want to copy. **Move the cursor to the bottom line, select the kit and press the Enter button.**



- 2) Next, select the source and destination zones, and confirm by pressing the Enter button. The source zone is from the kit you selected in the previous step. The destination zone is always in the current kit.

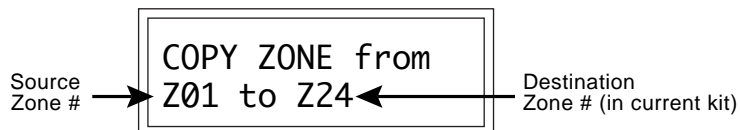

EDIT MENU**COPY STACK**

This function allows you to copy a stack from any kit, and place it in any of the 8 custom stack locations of the currently selected kit.

To Copy a Stack:

- 1) First select either the user kit containing the stack you want to copy or select "Factory Stacks". **Move the cursor to the bottom line, select the kit (or Factory Stacks) and press the Enter button.**

COPY STACK from
127 Eartha

- 2) Next, select the stack you wish to copy, and confirm by pressing the **Enter button**. The selected stack is from the kit you selected in the previous step.

Source Stack →

COPY STACK from
S001 Kicker

- 3) Select the destination stack, and confirm by pressing the **Enter button**. The destination stack is always in the current kit.

Destination Stack (in current kit) →

COPY STACK to
S001 Custom #1

SAVE KIT

Changes made to a kit in the Edit menu are not made permanent until the Kit is *Saved*. To save a kit, move the cursor to the bottom line and select the location for the new kit with the data entry control. The Enter LED will be flashing. Pressing the Enter button will confirm the operation. Any user kit (64-127) can be selected using the data entry control. Writing to a user kit erases the existing kit in that location. Make sure that the destination preset does not contain information that you wanted to keep.

SAVE KIT to
127 --Default--

To Save a Kit:

1. Select the new location.
2. Press Enter.

▼ In order to modify a factory stack, it must first be copied to a custom stack location.

EDIT MENU

EDIT MENU

The edit menu contains functions that can be modified by the user and then saved as kit information in one of the user kits. For example, the tuning or other parameter can be edited, then the kit can be saved to a user location (64-127).

While the Edit menu is activated, incoming MIDI kit changes are ignored. This is a quick and easy way to temporarily turn MIDI Program Change OFF.

WARNING!

Changes made in the Edit menu will be forever lost unless the kit is "saved" using the Save Kit function (page 69) before changing the kit.

TO ENABLE THE EDIT MENU

Press the Edit button, lighting the LED. The current screen will be the one most recently selected since powering up the machine. The cursor will appear underneath the first character of the screen heading on line one.

TO SELECT A NEW SCREEN

Press the cursor key repeatedly (or hold the cursor key while turning the data entry control) until the cursor is underneath the parameter value. (You may also press the Enter button to return the cursor to "Home" position.) Rotate the data entry control to select the screen.

TO MODIFY A PARAMETER

Press the cursor key repeatedly (or hold the cursor key while turning the data entry control) until the cursor is underneath the parameter value. Rotate the data entry control to change the value.

Note: In many cases, such as selecting Key Ranges, and Zones, the value may be changed from your MIDI controller by simply playing the proper key or drum pad. For example, to select a particular Zone, you would simply play the key or drum pad to which the Zone is assigned.

TO RETURN TO KIT SELECT MODE

Press the Edit button, turning off the LED.

EDIT MENU

PROCUSSION BLOCK DIAGRAM

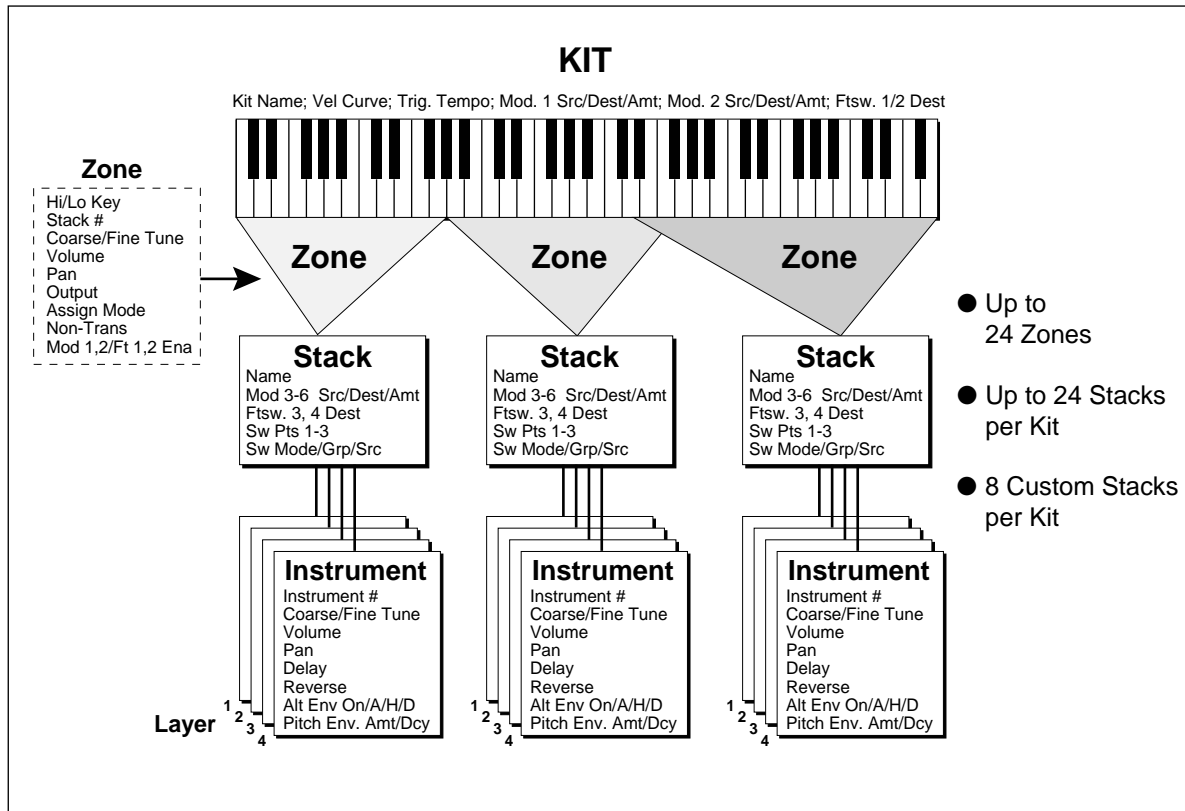

The Procussion is organized as shown in the diagram above.

A Procussion kit can be organized into four levels:

- 1) **Kit** - Parameters which affect the entire kit.
- 2) **Zone** - Parameters affecting the key assignment range.
- 3) **Stack** - A composite percussion sound.
- 4) **Instrument** - An individual instrument.

The Edit menu encompasses all levels of the kit. The display reveals information about which level you are currently editing.

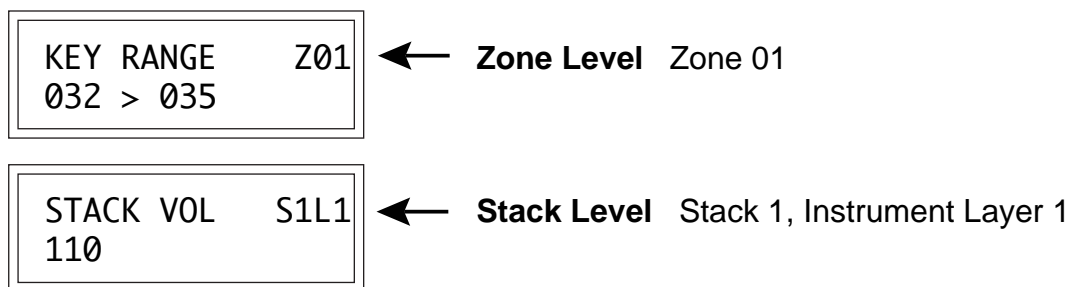

EDIT MENU

EDIT KIT FUNCTIONS

KIT NAME

Kit Name allows you to name each of the user kits with a name of up to 12 characters. Position the cursor under the character location and use the data entry control to change the character. The keyboard can also be used to select characters. The charts below show the keyboard character assignment.

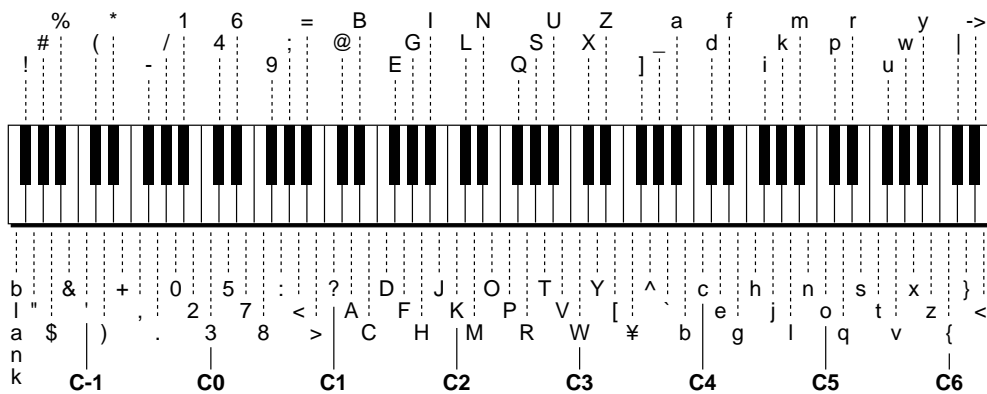
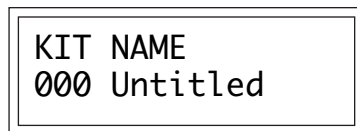

	C	C#	D	D#	E	F	F#	G	G#	A	A#	B	Pitch
-2						blank	!	"	#	\$	%	&	
-1	'	()	*	+	,	-	.	/	0	1	2		
0	3	4	5	6	7	8	9	:	;	<	=	>	
1	?	@	A	B	C	D	E	F	G	H	I	J	
2	K	L	M	N	O	P	Q	R	S	T	U	V	
3	W	X	Y	Z	[¥]	^	_	`	a	b	
4	c	d	e	f	g	h	i	j	k	l	m	n	
5	o	p	q	r	s	t	u	v	w	x	y	z	
6	{		}	→	←								

Octave No.

EDIT MENU

■ Zones can be easily selected by playing the MIDI note number assigned to that zone.

STACK SELECT

This function allows you to select which of the available instrument sounds (or none) will be placed in each zone of the current user kit.

```
STACK SELECT Z01
S002 Robert
```

■ The Key Range can be selected by simply playing the MIDI note numbers when the cursor is under the key numbers on the display.

KEY RANGE

This function allows you to assign each of the 24 zones to a range of MIDI keys. Zones may overlap, but only 2 zones may be assigned to the same key. If more than two zones are assigned, only the lowest numbered two zones will play. The original pitch of the stack will always be assigned to the exact center of the key range. If there are an even number of keys in the range, then the original pitch will be placed on the lower of the two center keys.

```
KEY RANGE Z01
036 -> 039
```

▼ If the Key Range function does not seem to be working properly, make sure the Zone Map function in the Master menu is set to Kit. You may be re-mapping the key assignments.

ZONE #1

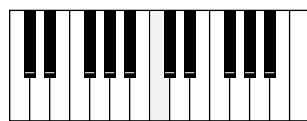

CENTER of ZONE

□ = Original Pitch

ZONE #2

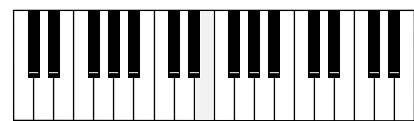

CENTER of ZONE

Zone #1 has an **Odd** number of keys in its range (25), so the original pitch of the stack falls exactly on the center of the zone. Zone #2 has an **Even** number of keys in its range (34) and the center of the zone is a key boundary, therefore the original pitch falls on the next lower key.

ZONE TUNING

This function allows you to change the overall tuning of the selected zone. Coarse tuning is in semitone intervals with a range of ± 48 semitones. Fine tuning is in $1/64$ semitone intervals (approx. 1.56 cents) with a range of ± 1 semitone.

■ Most factory stacks have been tuned to C.

```
TUNING Z01
CRSE+00 FINE+00
```

EDIT MENU**ZONE VOLUME AND PAN**

Volume sets the overall amplitude of the selected zone. This function also allows you compensate for the relative volume differences between stacks.

```
VOLUME PAN Z01
127     =Stack
```

Zone Pan allows you to set the initial pan position for each zone in the kit. A value of -7 pans the zone hard left and a value of +7 pans the zone hard right. This pan setting overrides the pan settings made at the stack level unless the screen is set to Pan = Stack. The pan setting made here is only valid if "K", for kit pan, is selected in the main display.

```
VOLUME PAN Z01
127     -7
```

The Pan Setting on the Main Screen Overrides Zone Pan!

```
C01 VOL127 PAN=K
071 Conga
```

← Pan in Main Screen must be set to **KIT** for Zone pan to have any effect.

NONTRANSPOSE

Nontranspose mode allows a stack to play throughout its assigned keyboard range, but at its original pitch only - there will be no transposition. Nontranspose mode can be turned On or Off for each zone.

When the Procussion is used with a MIDI keyboard you might want to play several keys at once for a thicker sound. Turning Nontranspose mode **On** would let all the notes play at the same pitch.

```
NONTRANSPOSE Z01
Off
```

■ Assign a non-transposed sound and play several keys at once for phasing/flanging effects.

EDIT MENU

■ If you don't want to use the assignment modes, set the zone to *Poly (32)*.

ASSIGNMENT MODE

There are a total of 32 output channels on the Procussion. The assignment mode affects note polyphony and interaction. Using assignment mode, each zone can be programmed to be polyphonic, with a certain number of available channels, or can be made monophonic with special assignments.

ASSIGNMENT	Z01
Poly (32)	

The various assignment modes are described below.

POLY (32)	Notes are played polyphonically, with dynamic channel assignment, using all 32 channels.
POLY (8)	Notes are played polyphonically, with dynamic channel assignment, but using no more than 8 channels at a time.
POLY (4)	Notes are played polyphonically, with dynamic channel assignment, but using no more than 4 channels at a time.
MONO	Any layer in the zone interrupts itself or any other layer, but does not affect other zones.
LAYER MONO 1	Any layer in the stack interrupts itself, but does not affect other layers or other zones.
LAYER MONO 2	Any layer in the zone interrupts any other layer, but does not affect its own layer or other zones.
EXCLUSIVE 1-8	The zone's stack is assigned to one of the 8 exclusive "channels". Notes in any zone in the kit will interrupt each other if they are assigned to the same exclusive channel.

■ Layer Mono 1 + 2 assignment modes are designed to be used in combination with Switch Mode.

For example, playing a fast roll on a ride cymbal in *Poly (32)* mode will assign a new channel on each strike which might tend to "muddy" the sound or use up too many output channels. One solution might be to use *Poly (4)* mode, which only allows the cymbal to use 4 channels.

You also might want the closed High Hat to cut off the open High Hat. In this case, you would assign the High Hats a *Mono* assignment.

EDIT MENU

If you had a cymbal crash on one drum pad and a choked cymbal on another, you might assign both zones to *Exclusive 1* (or any of the other exclusive channels) so that hitting the choke pad would cut off the crash.

ZONE SUBMIX

This function allows you to assign each zone to one of the 16 submix busses. The submix busses are routed to an output jack in the Master menu. For more information on Submixes, see pages 23 and 46.

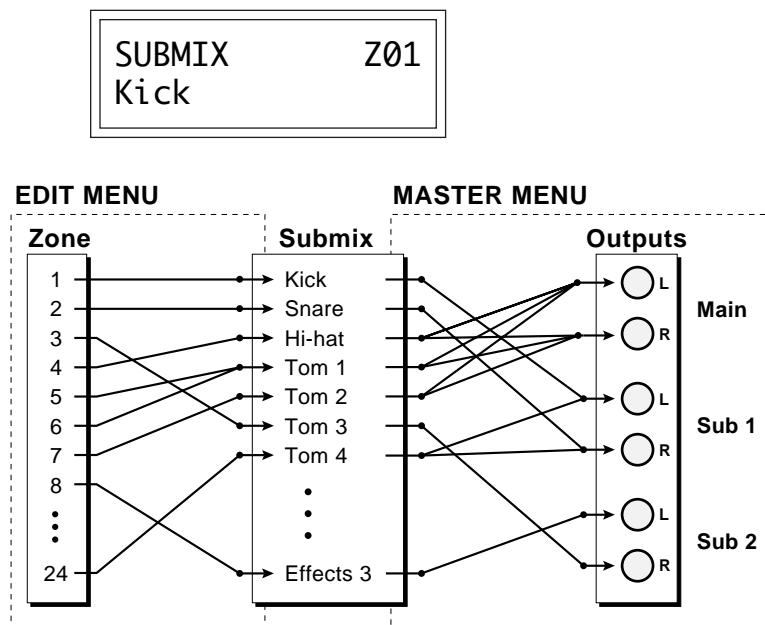

The Submix buss makes it easy to keep track of your output assignments.

MODULATION ENABLE

This function allows the Modulation 1 and 2 routings to be turned On or Off for each zone in the kit. (Modulation 1 and 2 affect the entire kit.)

For example, suppose you are using Modulation 1 to route Velocity-to-Volume, but you want your snare drum to be at a constant level. Simply turn Mod 1 **Off** for the snare drum zone.

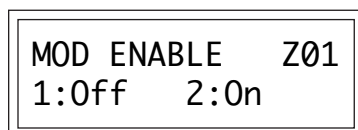

EDIT MENU

FOOTSWITCH ENABLE

This function allows the Footswitch 1 and 2 routings to be turned On or Off for each zone in the kit. (Footswitches 1 and 2 affect the entire kit.) For example, suppose you want Footswitch 1 to reverse zone 1 *only*. Simply turn FTSW 1 **Off** for all zones except zone 1.

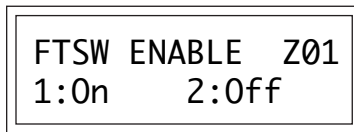

■ If the Modulation Patches do not seem to be working, check to make sure that the Modulation Enable is turned On for the Zone.

MODULATION PATCH 1 AND 2

These functions allow you to route modulation sources to any of the modulation destinations and affect **all** zones in the kit, although they may be turned On or Off for each zone. For each of the two modulation patches, there is a *Modulation Source*, a *Modulation Destination*, and an *Amount* parameter which is variable from -128 to +127. **Place the cursor under the appropriate parameter and change the patch number, modulation source, modulation destination, or the amount using the data entry control.** If a parameter is not labeled with a layer number, it affects all.

Modulation Sources:

- Velocity
- Key Number
- Trigger Tempo
- Random
- MIDI Control A/B/C/D
- Pressure
- Pitch Wheel

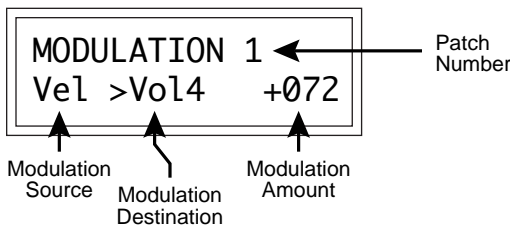

Destinations:

- Pitch, Pitch 1/2/3/4
- Volume, Volume 1/2/3/4
- Accent, Accent 1/2/3/4
- Attack, Attack 1/2/3/4
- Hold, Hold 1/2/3/4
- Decay, Decay 1/2/3/4
- Pitch Env. Amount
- Pitch Env. Amt 1/2/3/4
- Pitch Env. Decay
- Pitch Env. Dcy 1/2/3/4
- Pan, Pan 1/2/3/4
- Tone, Tone 1/2/3/4
- Sample Start
- Sample Start 1/2/3/4
- LFO Rate, LFO Amount

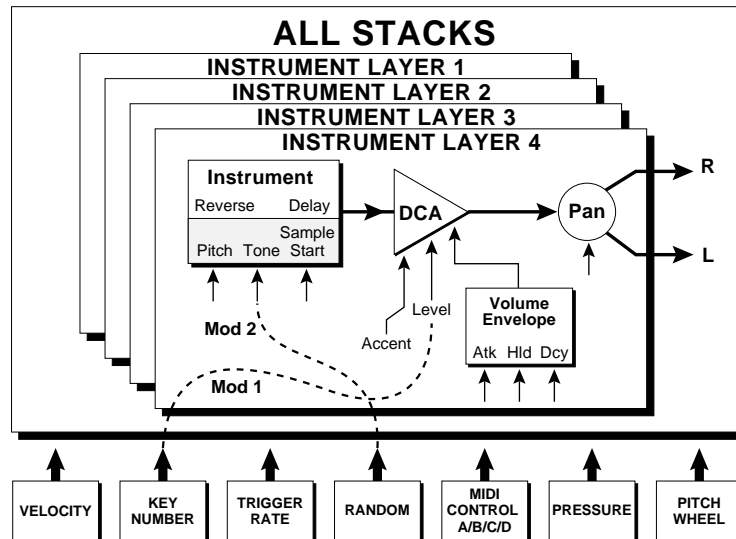

EDIT MENU**FOOTSWITCH CONTROL**

This function allows you to route the two kit level footswitches (1 and 2) to any of the footswitch destinations. These two “patchcords” affect all zones in the kit, although they may be turned On or Off for each zone. The footswitches can be routed to switch: Sustain (Layers 1/2/3/4 or All), Alternate Volume Envelope (Layers 1/2/3/4 or All), Reverse Sound (Layers 1/2/3/4 or All), or may trigger a Note-on event on any of the zones 1-8.

FOOTSWITCH
 1 > Note-on Z8

VELOCITY CURVE

Incoming velocity data can be modified by a velocity curve in order to provide different types of dynamics in response to your playing or better adapt to your MIDI controller. Velocity curves affect the entire kit. This function allows you select one of the 8 velocity curves, leave the data unaltered (Linear), or have the velocity scaled to full level (Constant). This velocity curve selection is only valid if the Global Velocity Curve in the Master menu is set to “Kit”.

VELOCITY CURVE
 Linear

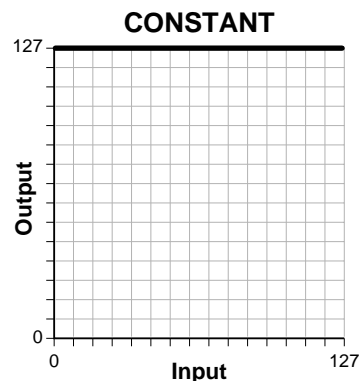
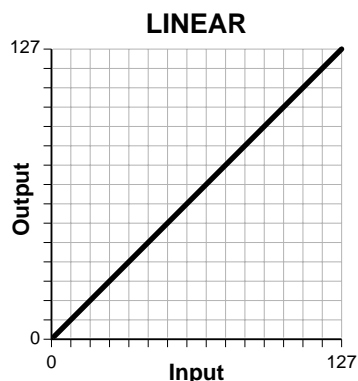

■ The Alternate Envelope must be initially turned **Off** in order for the footswitch to turn it **On**.

■ If the Footswitches do not seem to be working, check to make sure that the Footswitch Enable is turned On for the Zone.

■ Use a footswitch as a kick drum pedal by triggering a Note-on event.

EDIT MENU

VELOCITY CURVES

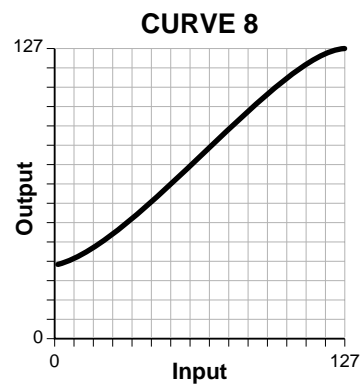
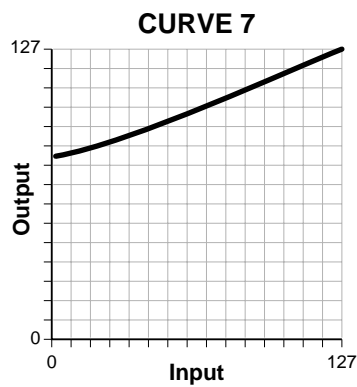
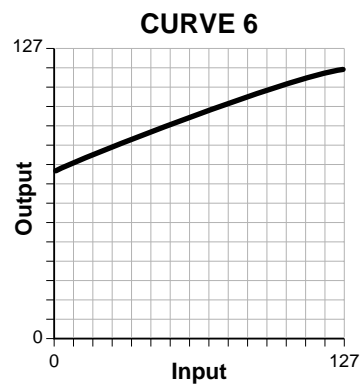
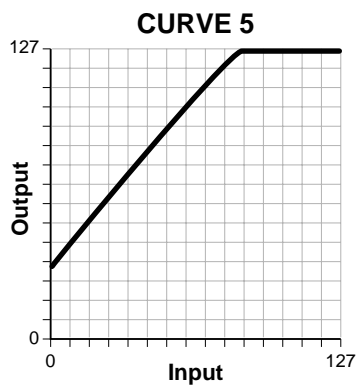
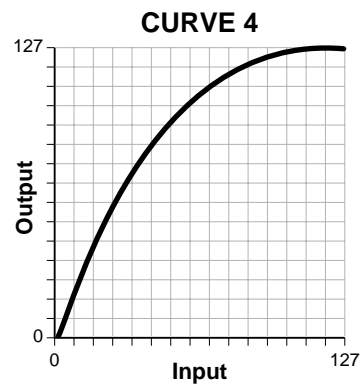
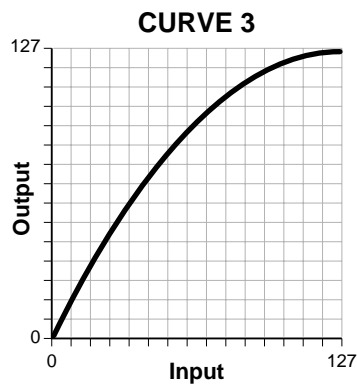
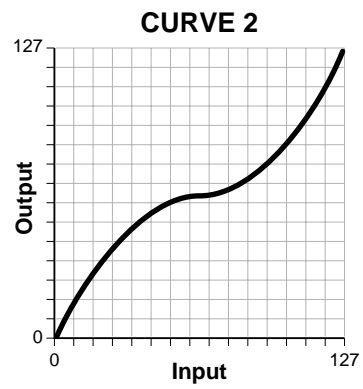
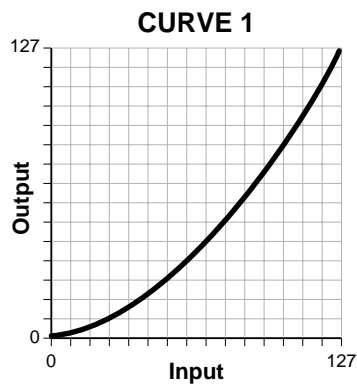

EDIT MENU

TRIGGER TEMPO

Trigger Tempo is a function which generates a control signal based on the tempo of your playing. When your playing tempo exceeds the selected Trigger Tempo, the amount of the control signal begins to increase from zero. This control signal can be used either to switch between drums in a stack or as a general controller which can affect virtually any parameter (see pages 64 + 67). For example, Trigger Tempo could be routed to raise the pitch as you play faster. Any tempo from 20 BPM (Beats-Per-Minute) to 260 BPM can be programmed. This Trigger Tempo setting is only valid if the Global Trigger Tempo set in the Master menu is set to "Per Kit".



STACK NAME

Stack Name allows you to name each of the 8 custom stacks (for each kit) with a name of up to 12 characters. Position the cursor under the character location and use the data entry control to change the character. A MIDI keyboard can also be used to select characters. The chart below shows the keyboard character assignment.

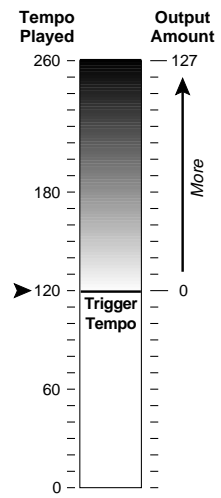
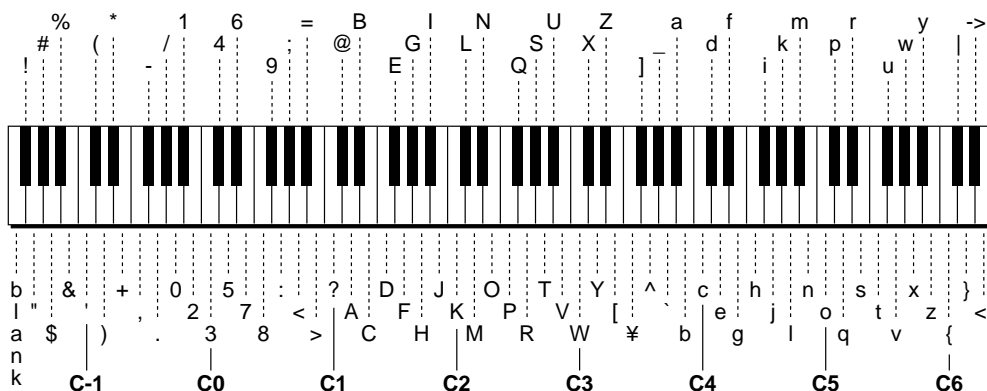
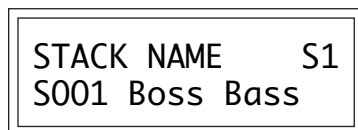

■ When the tempo of your playing exceeds the selected Trigger Tempo, the amount of the control signal increases from zero.

EDIT MENU

■ There are 8 custom stacks for **each** kit in the Procussion.

STACK INSTRUMENTS

This function allows you to select one of the available instrument sounds for each layer in the 8 custom stacks.

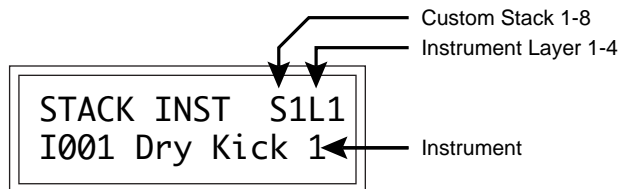

STACK TUNE

This function allows you to change the coarse and fine tuning of each layer in the 8 custom stacks. The coarse tuning range is ± 48 semitones (8 octaves) in semitone steps. The fine tuning range is ± 1 semitone in $1/64$ semitone steps (approx. 1.56 cents).

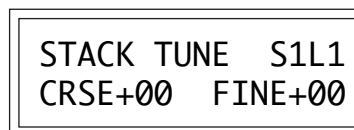

STACK VOLUME

Stack Volume sets the amplitude of each layer in the 8 custom stacks. This function allows you to blend the four instrument layers or compensate for the relative volume differences between instruments.



STACK PAN

Stack Pan allows you to independently set the initial pan position of each layer in the 8 custom stacks. A value of -7 pans the zone hard left and a value of +7 pans the zone hard right. The pan setting made here is only valid if "Stack" is selected in the zone pan setting and if "K", for kit pan, is selected in the main display.

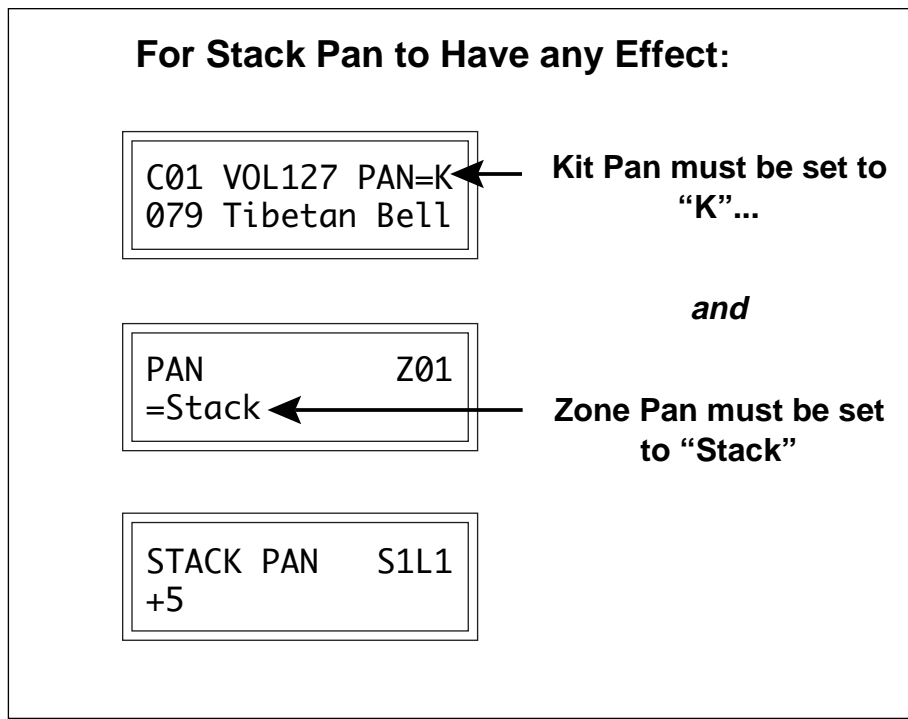

EDIT MENU**DELAY/SOUND START**

Delay varies the time between MIDI Note-on reception and the onset of the sound for each layer in the 8 custom stacks. The delay time is adjustable from 0-13 seconds (0-63).

Sound Start allows you to set where in the sample the instrument begins playing. A setting of 000 plays the instrument from the beginning; higher values move the sound start point toward the end of the sound.

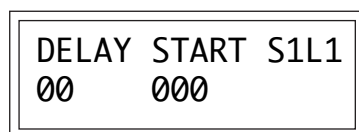

The Delay parameter is very useful in producing echo type effects and the Sound Start parameter can be used to remove the attack portion of the sound for "Procussion Synthesis" or to "fine tune" when modulating the Sound Start parameter with velocity or any other modulation source.

EDIT MENU**REVERSE**

When reverse is turned On, the instrument will be played backwards. Reverse can be turned On or Off for each layer in the 8 custom stacks.

REVERSE	S1L1
Off	

ALTERNATE ENVELOPE

Each instrument layer in the stack has its own preset Attack/ Hold/ Decay volume envelope which is normally employed. If a programmable volume envelope is desired, the alternate envelope is used. This screen allows you to turn the alternate envelope On or Off and set the Attack, Hold and Decay parameters for each layer in the 8 custom stacks.

ALT ENV	S1L1
On A00 H19 D33	

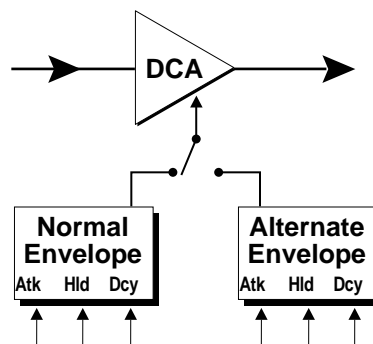
**PITCH ENVELOPE**

The Pitch Envelope is a “decay only” envelope which can control the pitch of an instrument. This screen allows you to turn the pitch envelope On or Off, and set the Decay and Amount parameters for each layer in the 8 custom stacks. Larger decay values increase the decay time. Similarly, larger amount values will increase the amount of pitch modulation. A positive envelope amount setting will sweep the pitch downward and a negative setting will sweep the pitch upward.

PROGRAMMING PROCUSSION

PROGRAMMING PROCUSSION

CREATING A CUSTOM KIT

Creating your own custom kit is easy. First, you select the key range for the zone. Then you may simply select the desired stack from the palette of pre-programmed factory stacks. Repeat the two steps until you have a large enough drum kit. You may assign up to 24 stacks to a kit and a zone may contain 1 or 2 stacks.

BUILDING A CUSTOM KIT ... STEP BY STEP

- 1) Select one of the "--default--" kits which are located at numbers 105-127.
- 2) Press the **Edit** button and go to the second screen, "STACK SELECT".
- 3) Play the **Pad** or **Key** to select the Zone.
- 4) Move the **Cursor** underneath the Stack number and use the **Data Knob** to change stacks until you find one you like.
- 5) Repeat steps 3 and 4 until your kit is complete. Then press **Enter**.
- 6) If you wish to rename your new kit, do so now using the "KIT NAME" function.
- 7) Rotate the **Data Knob** to the last screen, "SAVE KIT". Move the **Cursor** to the lower line and press **Enter**.

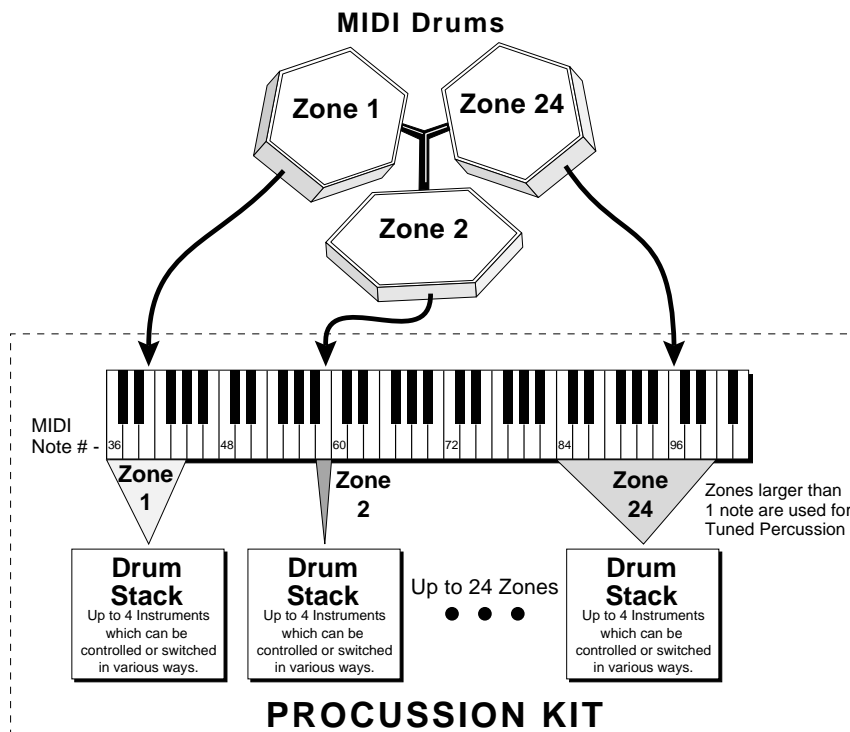

■ If you are using the Procussion with a MIDI keyboard, set the Zone Map to "Kit" (Master Menu). If you are using MIDI drum pads or a drum machine you should use one of the User Zone Maps or a Zone Map which is preprogrammed for your controller.

■ The center of the zone is always the original pitch of the stack. The original pitch of most factory stacks is set at "C". If the zone is out of tune, use the Zone Tuning function to tune the stack to the correct pitch.

PROGRAMMING PROCUSSION

EDITING KITS

The easiest way to make a kit is to edit an existing kit. This is also an excellent way of becoming familiar with Procussion. You can find a kit that is almost the way you want it and then slightly modify it to suit your taste. If you don't like what you hear, simply change the kit and Procussion reverts back to the original sound. Changes are not made permanent until you *Save* them using the "SAVE KIT" function, which is the last screen in the Edit menu. We'll start with a function that has an obvious effect on the sound; Stack Tuning. First, choose a kit that strikes your fancy and press the Edit button.

CHANGING THE TUNING OF A ZONE

Changing the tuning of a zone is something you will often want to do. And it's so easy. Scroll through the Edit menu until you come to the screen:

TUNING	Z01
CRSE+00	FINE+00

Move the cursor under the Zone Number (using the cursor button) and play the keyboard key or drum pad containing the stack you want to tune. The proper zone will automatically be selected.

Next, move the cursor to the bottom line so that it is underneath the Coarse Tuning amount. As you play the stack, turn the data knob to change the tuning in semitone intervals. The Fine Tuning parameter changes the tuning in 1/64 of a semitone intervals.

By moving the cursor back under the Zone Number you could select the next zone to be tuned. Easy, isn't it? And, if you wanted to save the new tunings? Press the Enter button and continue.

SAVING YOUR WORK

Every time you have made a series of changes to a kit that you would hate to lose, you should *SAVE* your work using the "SAVE KIT" function which is the last screen in the Edit menu. Kits can be save to any of the User Kit locations 64-127. Kits 105-127 have been left empty to encourage you to modify and save your own custom kits.

PROGRAMMING PROCUSSION

TO SAVE A KIT

- 1) Turn the **Data Knob** clockwise until you get to the last screen, "SAVE KIT".
- 2) Move the **Cursor** to the lower line in the display.
- 3) Turn the **Data Knob** to select the Kit number where the new kit will be placed (64-127). *Remember* - Writing to a kit location erases whatever kit was already there.
- 4) When you have selected the new kit location, press **Enter**. The display will say, "SAVING KIT". The kit is now saved.

▼ **Saving a Kit overwrites the previous Kit in that location!**

BUILDING YOUR OWN STACKS

Let's go a step further now and create a hot new sound completely from scratch. In order to get the most out of this section, you should have already read the Programming Basics section of this manual and have a basic understanding of the Procussion architecture.

Assign a Custom Stack

There are 8 Custom Stacks for each User Kit in Procussion.

- 1) Select one of the "--default--" kits which are located at numbers 105-127.
- 2) Press the **Edit** button and turn the **Data Knob** clockwise to the second screen, "STACK SELECT".
- 3) Move the **Cursor** to the lower line and select "Custom #1", then press **Enter**.
- 4) Turn the **Data Knob** clockwise to the next screen, "KEY RANGE". Choose zone 1 with cursor or data knob or by playing a key.
- 5) Move the **Cursor** to the lower line by pressing it twice. The display should look like this, with the cursor under the first key number:

■ *When first learning your way around Procussion, keep your eye on the flashing cursor to make sure it is under the correct parameter.*

KEY RANGE	Z01
036 -> 036	

PROGRAMMING PROCUSSION

- 6) Play a note on your Keyboard or Drum Pad, and press the **Cursor**.
- 7) Play the note again and press **Enter** to assign the zone to a one-note range. (The one-note range is only for simplicity. You may of course, assign a wider range if desired.)

Select and Tune Instruments

- 8) Turn the **Data Knob** clockwise until you find the screen:

■ *The cursor can be moved to the function select position (top-left) by pressing Enter or by using the cursor control. Either method is fine.*

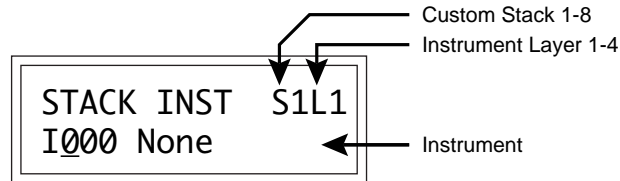

Set the Stack and Layer numbers to S1 L1 as shown above.

- 9) Move the **Cursor** to the lower line as shown above.
- 10) While playing the note that you assigned in step 7, turn the **Data Knob** until you find an instrument that you like. Press **Enter**.
- 11) Turn the **Data Knob** clockwise to the next screen:

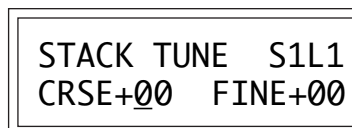

- 12) Move the **Cursor** to the lower line underneath the Coarse Tuning value. Now turn the **Data Knob** to change the tuning. Notice how you can completely change the character of the sound by tuning it out of its normal range. Also notice the distortionless pitch shifting from Procussion that makes this possible. Tune this first layer to your liking, then press **Enter**.
- 13) Now go back to the "STACK INST" screen to select the instrument for layer 2.
- 14) Move the **Cursor** underneath the Instrument Layer parameter (see the diagram above) and use the **Data Knob** to select Layer 2.

PROGRAMMING PROCUSSION

- 15) Now move the **Cursor** back down to the bottom line and repeat steps 10 through 12. Try to find an instrument which complements the first one you selected. Remember that the tunings have a lot to do with how an instrument sounds. Play around awhile with the instruments and tunings until you have a composite sound that you like. If you want, you can even add a third or fourth layer to the brew. In any case, press **Enter** to select the next screen.

This might be a good time to introduce another cool feature, “**Audition Layer**”. This feature allows you to completely mute all layers but the one you are working on. It is often useful, when working on a complex sound, to be able to hear exactly what you are doing to a single layer.

- 16) Turn the **Data Knob** until you find the screen “AUDITION LAYER” and move the cursor down to the lower line. Use the **Data Knob** to select Layers 1, 2, 3, or 4. When you are finished, be sure to turn Audition Layer “Off” again and press **Enter**. Now, back to our programming.

Volume and Panning

- 17) Turn the **Data Knob** counter-clockwise until you find the screen:

STACK VOL	S1L1
100	

Now we will adjust the relative volumes of the instruments. This can really “fine tune” the composite sound.

- 18) Go back and forth between the **Layer** and the **Volume** amount while playing the sound until you get the mix just right. Don't turn any of the levels up full or you won't be able to add accents later (the volume will already be “Maxed”). A maximum setting of around 100-110 will leave a little headroom.
- 19) Move the cursor back up to the top line by either pressing **Enter** or simply pressing the **Cursor** button until it is underneath “Stack Vol”.

PROGRAMMING PROCUSSION

- 20) Turn the **Data Knob** to the next screen, "STACKPAN". Adjust the pan positions to hear how this separates the layers. Leave them set near center (0-2) and press **Enter**.

Delay, Sound Start and Reverse

- 21) Turn the **Data Knob** to the next screen, "DELAY/START". Play around with these two parameters and note the effects. Delay will be obvious. Sound Start removes samples from the start of the sound. A setting of 000 plays the sound from the beginning, higher values move the start point toward the end of the sound. These parameters may or may not appeal to your artistic sensibilities. In any case, now you know what they do. *Next...*

→ → → → → →

From here on out we'll dispense with the step-by-step explanations since you are probably becoming familiar with the way Procussion operates.

- 22) Let's move on to the next screen - **Reverse**. Reverse can be turned on or off for each layer. Try reversing each layer and note the effects. Reverse works especially well for special effects. *Next function ...*

- 23) **Alternate Envelope**. This function allows you to change the default volume envelope for each instrument. The Alternate Envelope is a really powerful function for shaping the sound. Percussion sounds and waveforms can be shaped and blended over the course of the sound, creating new and dramatic textures.

When first working with this function, keep track of which layer you are working on and where your cursor is located. It's easy to get confused and modify the wrong layer. You may want to make use of the Audition Layer function while experimenting with the Alternate Envelope, as it will allow you to hear each layer separately.

- 24) **Pitch Envelope**. The Pitch Envelope allows you to add a pitch sweep (up or down) to each layer of your stack. The decay time of the sweep and the amount are adjustable. Positive amounts sweep the pitch down and negative amounts sweep the pitch up. This is another powerful synthesis function which can completely change the character of a sound. The effect of this function can be subtle or very obvious. Try changing the initial tuning of the instrument as it relates to the Pitch Envelope.

- 25) **LFO**. The LFO (or Low Frequency Oscillator) allows you to cyclically sweep either the pitch or the volume of any layer. Note that there is

PROGRAMMING PROCUSSION

only one LFO for all four layers. There are four different LFO waveforms from which to choose from, as well as a rate (speed) and amount parameter. Modulating the pitch is an easy way to hear the effects of the different waveforms.

- 26) **Stack Modulation Routings 3-6.** We'll walk you through this one since it can be confusing. You can make four "patches" in this module (3, 4, 5, 6) to connect modulation sources to destinations.

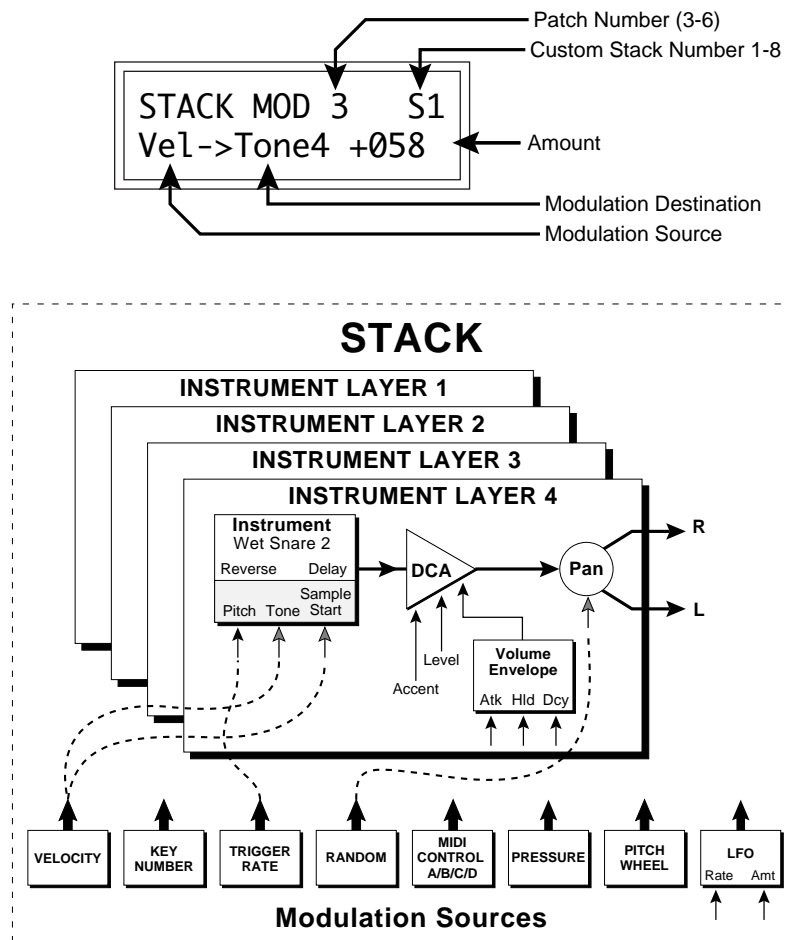

Note how the screen parameters relate to the stack block diagram. Try making a few "patches" and note the effects. The flexible modulation routing scheme is probably the most powerful feature of Procussion because it allows you to produce subtle variations in the sound using performance parameters such as velocity, playing speed, etc. Remember that everything is "legal" when it comes to making music. Experiment!

PROGRAMMING PROCUSSION

- 27) **Using Trigger Tempo.** Trigger Tempo is a modulation source which increases from zero when your playing speed exceeds a preset tempo. First of all, go into the Master menu and turn to the Global Trigger Tempo screen. Set it to 150 beats-per-minute as shown below.

GLOBAL TR TEMPO
 150 BPM

Go back to the Edit menu, Stack Modulation screen and route Trigger Tempo to control the Pitch as shown below. Now start playing, slowly at first, then faster. Notice that the pitch stays constant until you play faster than 150 BPM, then it begins to increase. That's how it works!

MODULATION 3
 Trig->Pitch +100

Further your experiments by using Trigger Tempo as a switch source to switch in different instrument layers depending on your playing speed. As an example, copy Stack 150, "Rapper Snare" to a User location (in a Default Kit). Set *Switch Mode* → *Threshold*; *Switch Source* → *Trigger Rate* and play. The Tempo controls which layers are heard.

- 28) **Routing the Pitch Wheel to Control ... Pitch.** This is something that you might want to do either at the **Stack** level (to affect only one Stack) or at the **Kit** level (to affect all the Stacks in the Kit). For now let's control the pitch of the entire Kit. The Modulation 1 and 2 parameters affect the entire Kit. Simply set the Modulation 1 (or 2) screen as shown below and *voilà*, Pitch Wheel control. Incidentally, the setting of +114 will produce a pitch bend interval of a perfect fifth. See the Pitch Modulation Interval Charts (in the Reference Section) for more information.

MODULATION 1
 PWhl->Pitch +056

■ *Modulation destinations followed by a number (Pitch 1, Pitch 2, etc.) affect only one layer. Destinations without numbers affect all layers.*

■ *By setting the Global Trigger Tempo to MIDI Clocks, the Trigger Tempo rate will follow along with a sequencer or drum machine.*

▼ *Modulation Enable must be turned On for each Stack or the Pitch Wheel will not work!*

PROGRAMMING PROCUSSION

HI-HAT INVESTIGATION

The Hi-Hat is perhaps the most expressive part of a drum set. Procussion offers expressive Hi-Hat control; up to 4 different Hi-Hat samples can be switched-in depending on the position of a pedal or control wheel. Many of the factory kits already have a Hi-Hat programmed to respond to the Modulation Wheel of a MIDI keyboard. The Hi-Hat is assigned to MIDI key number 52 (Zone 9). Play key number 52 (E) while moving the Modulation Wheel. You will notice that the closed Hi-Hat sound triggers as the wheel nears maximum. If you are using a MIDI drum pad setup, you will need a continuous controller pedal which has its output translated into MIDI. The diagram on page 12 shows one such arrangement.

Copy Stack

In order to modify a factory stack, it must first be copied to a user location.

1. Start with a Default Kit (105-127) in the **Edit Menu**.
2. Press the Edit button and move to the second to last screen, **Copy Stack**.
3. Copy from: Factory Stacks. Select #243 Mod Hi-Hat 2 (for this example).
4. Copy to: Custom #1 (or any of the Custom Stacks).

Assign the Hi-Hat

1. Set **Stack Select**, Zone 9 to: ModHiHat 2
2. Set **Key Range**, Zone 9: 052 -> 052.
3. Play MIDI Key # 52. You should be hearing the Hi-Hat.

Examination of the Hi-Hat

1. Go to the **Stack Inst.** screen. Move the cursor to the Layer (L1) and turn the data knob. You will see that the ModHiHat 2 stack is made up of four instruments; L1-HihatB open, L2-HihatB 2/3, L3-HihatB 1/3, L4-HihatB shut. Press **Enter** to return to the screen identifier.
2. Turn to the **Switch Mode** screen. Notice that the switch mode is **Hi-Hat**.
3. Turn to the **Switch Source** screen. Notice that the switch source is **Control A**. Control A is normally a Modulation Wheel. Alternately, a control pedal can be used as shown in the drum kit diagram on page 12. (If you do not understand the concept of Control A, see pages 44 and 45.) There are other possible sources such as: Velocity, Trigger Rate, etc., but when in Hi-Hat mode, only controllers A-D will have any effect.
4. Turn to the next screen, **Switch Points**. Think of the Modulation Wheel or Pedal as going from 0-127. These are the points at which the different Hi-Hat Instruments will be switched in. Try changing the switch points and note the effects. The points should be in an ascending order for this function to work correctly. Now continue on your own. *Experiment!*

■ You can create custom Hi-Hats by simply changing the instruments.

■ You can change the switch points to adjust the modulation wheel or pedal to your own specifications.

PROGRAMMING PROCUSSION

ON YOUR OWN

In the course of these exercises you have hopefully learned a little about programming a Procussion Stack. You can experiment as much as you want and when you come up with something good, save it to one of the empty kit locations. Feel free to try out all the other parameters that we did not cover such as the Footswitches and other Super-Switch modes. Simply trying out the various functions will remove a lot of the mystery associated with them. Procussion is an extremely powerful tool which will do a lot of things that no one has even thought of yet. Dig in and discover them yourself.

PROGRAMMING TIPS and IDEAS

- Use the Stack Select screen in the Edit menu to monitor which stacks you are playing. This is also a quick way to temporarily disable MIDI program changes.
- Routing Velocity to Sound Start with a negative amount will remove the Attack portion of the drum when played softly, simulating the effect of an actual drum head.
- Remember that the center of the Zone is always the original pitch of the Stack (usually C), so you may have to retune the stack using the Zone Tune function when creating tuned instruments such as Marimbas.
- Key Number can be routed to control Pitch (+ or -) in order to change the normal equal tempered tuning relationship between notes.
- Remember that Sample Start, Tone, Attack and Pan Position are set at the beginning of the note. Continuous controllers used after the start of the note (such as pressure) will not have any effect.
- In order to modify a Factory Stack, it must first be copied to a Custom Stack location.
- Interesting factory ROM stacks may be analyzed by first copying them to RAM stack locations and then examining the various parameters.

PROGRAMMING PROCUSSION

PROCUSSION SYNTHESIS

Procussion Synthesis is a form of additive synthesis. Normal additive synthesis uses simple sine waves as the basis of its sound. In Procussion Synthesis, we start off with complete sampled sounds or complex waveforms and combine all or part of these together to form new sounds. The process is illustrated below.

PROCUSSION SYNTHESIS

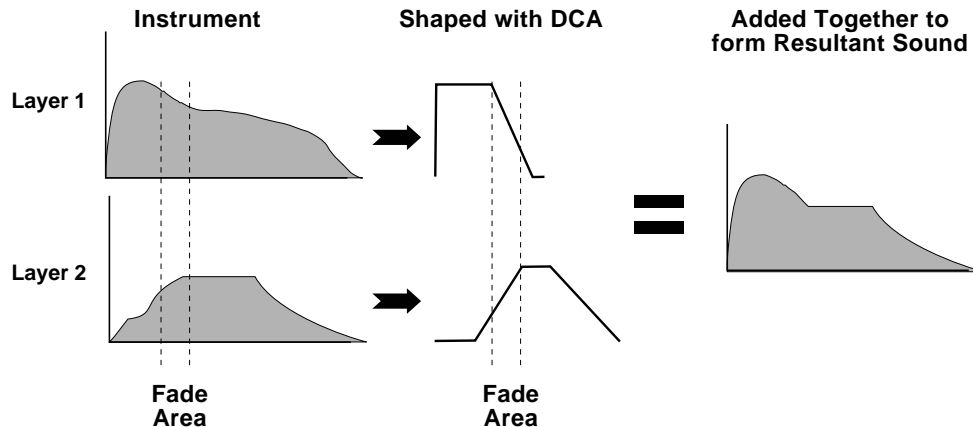

In this example, portions of two sounds are dynamically crossfaded in order to produce a new sound containing elements of both.

The envelope generators controlling the DCAs (digitally controlled amplifiers) can be used to fade between up to four instruments during the course of a note. This powerful technique allows you to combine elements of different instruments together to form completely new sounds. New sounds that are totally natural, because they are based on natural sounds. Procussion also contains many digitally generated waveforms that may be combined with other digital waves or with the sampled instruments in order to change the character of the sound, perhaps to add a digital "edge" or add more bottom. In addition to the envelope generators, parameters such as Tone, Tuning, Delay, Sound Start, and Super-Switch allow you to further control the texture and blend of the four instruments.

PROGRAMMING PROCUSSION

As an example, let's combine two cymbals in order to create a new cymbal containing elements of both. Use one of the 8 Custom Stacks in a "Default Kit" for your experiments. Refer to the Edit menu parameters in the chart below and do not change any parameters but the ones specified.

The **Ride Bell** instrument is used for the "Attack" (or the sound you hear when the cymbal is first struck). We'll put this sound on layer 1. The **19" Pang** instrument is used for the "Decay" (or the sound you hear after the initial strike until the sound fades away). The Pang sound will be layer 2. The 19" Pang cymbal doesn't seem to quite fit with the Ride cymbal somehow, but by tuning it up an octave, it sounds fine. Next we'll adjust the Delay of the Pang so that it comes in after the Ride Bell sound. Moving the Sound Start parameter of the 19" Pang to 124 removes the attack portion of the cymbal since we only want to hear the Ride Bell at the start of the note. The Alternate Envelope generators are used to fade out the Ride Bell during the decay portion of the sound and also to shorten the 19" Pang's decay a little. Finally we adjust the volume of the Pang cymbal to match it up with the Ride Bell. That's it! You have just bought yourself a new cymbal!

Stack Name: Ride Pang							
Layer 1				Layer 2			
Instrument: Ride Bell				Instrument: 19" Pang			
Tuning: C:00 F:00				Tuning: C:12 F:00			
Volume: 100				Volume: 074			
Pan: +0				Pan: +0			
Delay: 00				Delay: 03			
Sound Start: 000				Sound Start: 124			
On	A	H	D	On	A	H	D
	00	02	21		00	23	36

The example above shows one way that you can transform the ROM instruments into completely new sounds. In this example we have only used two layers and no modulation parameters at all! Remember that you can have up to *eight* layers by assigning two zones to a key range.

Next, we'll cover another exciting new technique, *Spatial Convolution*.

PROGRAMMING PROCUSSION

SPATIAL CONVOLUTION

"It's technical..." Spatial Convolution is a technique of adding reverb ambience to the sound by combining a "convolved" reverb sound with a "dry" drum sound of the same type. Convolution involves combining two sounds so that only frequency components common to both sounds are accentuated while uncommon frequencies are discarded. In simple terms this produces a nearly ideal reverb "tail" that can be tuned and shaped like an ordinary sample. There are four Spatial Convolution "spaces" (instruments 132-135) in Procussion which were created using the Transform Multiplication function on our Emax II 16-bit sampler.

Enough tech talk. Let's get busy and add some space to the sound. As before, use one of the 8 Custom Stacks in a "Default Kit" for your experiments. Set up the Edit menu parameters as in the chart below and change only the parameters specified.

Stack Name: Ambient Snare			
Layer 1	Layer 2	Layer 3	Layer 4
Instrument: Dry Snare8b	Instrument: Dry Snare 7	Instrument: Snare Space	Instrument: Snare Space
Tuning: C:00 F:-55	Tuning: C:00 F:00	Tuning: C:00 F:+12	Tuning: C:-01 F:-26
Volume: 100	Volume: 095	Volume: 100	Volume: 100
Pan: +0	Pan: +0	Pan: +7	Pan: -7
Delay: 00	Delay: 00	Delay: 00	Delay: 01
Sound Start: 000	Sound Start: 000	Sound Start: 000	Sound Start: 085

Examine the first two layers. This is a straightforward combination of two snare sounds. Layer 1 has been slightly detuned in order to "fatten up" the sound a bit. In layers 3 and 4 things start to get interesting. Notice that we are using the same instrument (#134-Snare Space) on both layers, one panned hard right and the other hard left. In addition they are quite detuned from each other in order to give each one a separate identity. The Delay and Sound Start parameters are used on layer 4 to prevent flanging effects which occur when identical samples are mixed together. Use the Audition Layer function in order to hear what each layer contributes to the overall sound. You will be impressed!

The reverb tail can be further shaped using the Alternate Envelope, Reverse, the Pitch Envelope or any of the other modulation parameters.

PROGRAMMING PROCUSSION

USING PROCUSSION WITH A SEQUENCER

We thought you'd never ask. Procussion was designed from its conception with multi-timbral sequencing in mind. Just take a look at the main screen.

```
C01 Vol127 Pan=K
000 Ampitheatre
```

The kit for each MIDI channel is selected from the main screen. Press the cursor button to move the cursor up so that it is underneath the channel number.

```
C01 Vol127 Pan=K
000 Ampitheatre
```

Turn the data entry control and you will see that every MIDI channel has a kit assigned to it. Just select a kit for each of the MIDI channels. It's simple! In order to respond to multiple MIDI channels, Procussion must be in Multi-Mode. Multi-Mode is selected in the Master menu. Press the Master menu button and use the data entry control to scroll through the screens until you find MIDI MODE.

```
MIDI MODE    ID
Multi       00
```

Move the cursor down to the second line and change the mode to Multi as shown. Procussion will now respond to multiple MIDI channels.

MORE ADVANCED SEQUENCING

PRE-SEQUENCE SETUP

Suppose that you want to have your sequencer set up everything for you before the start of the song. Good idea. This will make the Procussion setup procedure automatic and prevent the wrong kits from playing.

PROGRAMMING PROCUSSION

The basic idea of a pre-sequence setup is to send out MIDI information just before the start of the song. This MIDI information will select all the proper kits, adjust the mix, and pan positions of each kit.

Note: Procussion setup information should be transmitted from the sequencer *before* the song actually starts, perhaps during a lead-in measure or countdown. **DO NOT** send setup information just before the first beat of the song or MIDI timing errors could result.

INITIAL SETUP

1) Set PAN in the main screen to any setting other than Kit. This allows Procussion to receive pan data over MIDI.

In the Master menu:

- 2) Turn ON Multi-Mode
- 3) Turn ON Kit Change enable for each channel.
- 4) Turn OFF MIDI Enable on MIDI channels that are to be used for other instruments.

KIT, VOLUME and PAN SETUP

Program your MIDI sequencer to transmit the following information before the song starts.

- 1) Select the proper kits for each MIDI channel used on Procussion (program change command).
- 2) Send MIDI volume information (controller #7) for each MIDI channel used on Procussion.
- 3) Send MIDI pan information (controller #10) for each MIDI channel used on Procussion.

Now your song will play perfectly every time using the proper kits, volumes and pan positions. In addition, kits, volumes and pan positions (or anything else for that matter) can be adjusted in realtime during the song. Note: If the wrong kits are being selected, check the MIDI Program -> Kit map.

To carry the pre-sequence setup even further, you can even include kit data for each kit used in the sequence. See page 30 for details.

■ *Transmitting the Master Settings will set up the Kit, Volume and Pan information for all 16 MIDI channels.*

PROGRAMMING PROCUSSION

CHANNEL RIPOFF

In very rare instances you may encounter what is commonly known as “channel ripoff”. When Procussion uses up all its 32 channels and needs more, it steals a channel from the key that has been held the longest. Because percussion sounds are generally so short and because 32 instruments are almost never played all at once, the “ripoff” effect would probably only occur when using Procussion in multi-timbral mode. Since Procussion dynamically allocates channels as needed, to eliminate ripoff you must either, play fewer notes, or use simpler stacks (ones without all four layers used).

USING EXTERNAL PROCESSING

Don't be afraid to use external processing on specific sounds if you feel the urge. The submix sends and returns on Procussion are there for a reason. In many instances a bit of reverb or EQ will be just the thing a drum stack needs to give it a distinct identity. By dedicating a multi-effects box to a submix out/in, you can open up a whole new world of possibilities by effecting only those drums you have routed through the submix.

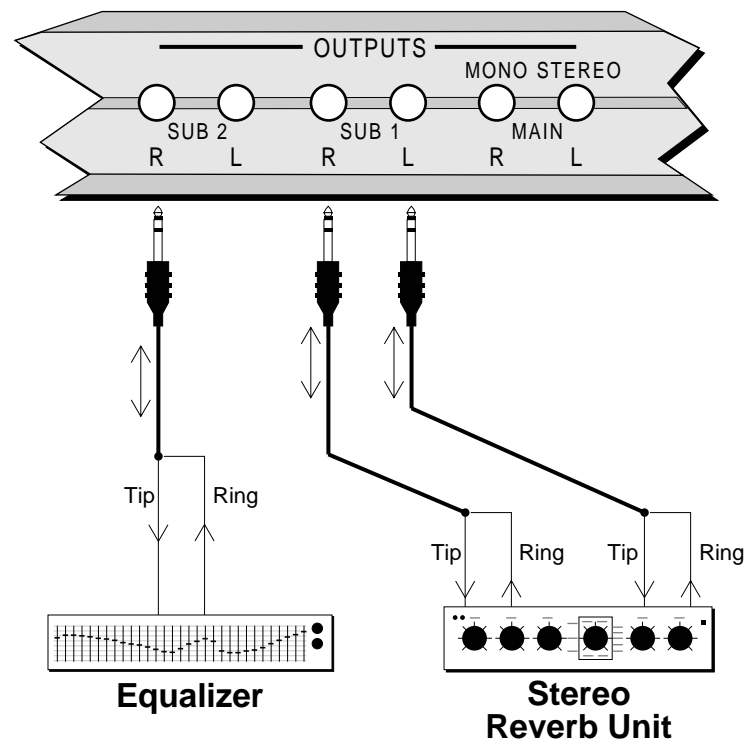

REFERENCE SECTION

PROCUSSION FACTORY KITS

ROM KITS

- | | |
|---------------------|---------------------|
| 0. Ampitheater * | 32. Rocket Drums |
| 1. Mega Drums * | 33. Huge Room * |
| 2. Rock n Roll * | 34. Churchyard |
| 3. Palladium * | 35. Drum Dance * |
| 4. Jazz Drums * | 36. Percussion 3 |
| 5. Metal Drums * | 37. Mallet Bells |
| 6. Rap Session * | 38. Hip House |
| 7. Latin Drums | 39. Latin Layers |
| 8. Percussion 1 | 40. Big Band |
| 9. Tool Kit | 41. Multi FX |
| 10. Ambient Rock * | 42. Heaviosity * |
| 11. Acoustic Kit * | 43. Ritual Night |
| 12. Thundadome | 44. Dance Club * |
| 13. Disco Ball | 45. Indo Steel |
| 14. Vibrations | 46. Orch Perc |
| 15. Rock Drums * | 47. Country Kit * |
| 16. House Machine * | 48. Killer Synth |
| 17. Fusion Stix * | 49. Heavy Handed |
| 18. Found Sound | 50. Percussives |
| 19. Marimba | 51. Mystic Land |
| 20. Space Drums * | 52. Beach Party |
| 21. Hard Rock * | 53. Intervallix |
| 22. Stadium Rox * | 54. Jazzy Traps |
| 23. Dance 2000 * | 55. Clavarimba |
| 24. Industry | 56. Rockabilly * |
| 25. Heavy Metal * | 57. Control Snares |
| 26. Hip Hop * | 58. Lotsa Kicks |
| 27. Rosewood Tine | 59. All Snares |
| 28. Percussion 2 | 60. More Toms |
| 29. Sound FX | 61. More Cymbals |
| 30. Sluggo Drums * | 62. More Percussion |
| 31. Beat Box | 63. More Basses |

■ The ROM kits listed on this page are permanently located in kits 0-63.

The User Kits 64-127, are listed on a separate insert page which allows them to be easily updated.

■ Kits marked with an asterisk (*), follow the standard kit layout shown on the following page.

STANDARD FACTORY KIT LAYOUT

This diagram shows the layout of the standard trap kits in Procussion. Special kits, such as Latin Percussion or Sound Effects, will not follow the standard layout.

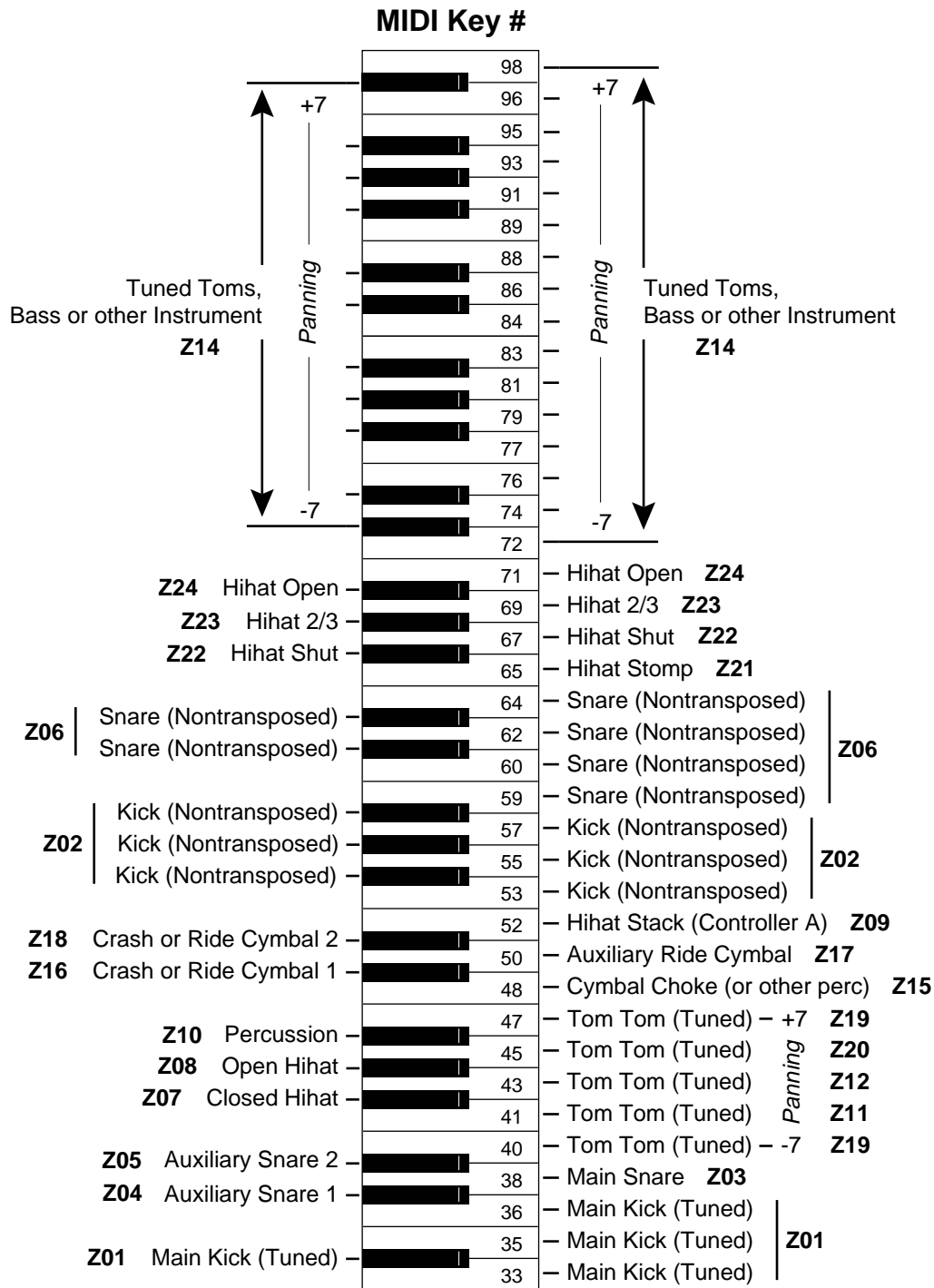

PROCUSSION FACTORY STACKS

9. Dry Kick 1
10. Dry Kick 2
11. Dry Kick 3
12. Dry Kick 4
13. Dry Kick 5
14. Dry Kick 6
15. Room Kick 1
16. Room Kick 2
17. Gated Kick
18. Round Kick
19. The Kicker
20. Fat Kick
21. Mansion Kick
22. Big Foot
23. Bonzo Kick
24. Good Kick
25. Wet Kick 1
26. Wet Kick 2
27. Wet Kick 3
28. Wet Kick 4
29. Wet Kick 5
30. Thick Kick
31. Kick Punch
32. Reek Keek
33. ModSnapKik
34. Kahnbo Kick
35. Metal Kick
36. Havok Kick
37. Cave Kick
38. Boom Bass
39. Bellow Kik
40. Kooky Kick
41. Kick Space
42. DrkK-Space
43. House Kick 1
44. House Kick 2
45. House Kick 3
46. Dance Kick
47. Rap Kick
48. ModToneRap
49. Cymbal Kick
50. Floor Kick
51. Janz Kick
52. Mambo Kick
53. Rapper Kick
54. Kick In
55. SuprSinKik
56. Butt Kicker
57. Space Kick
58. Growth Kick
59. Tam Kick 1
60. Tam Kick 2
61. Tam Kick 3
62. Kick Shake 1
63. Kick Shake 2
64. Tik Kick
65. Kidz Kick
66. Trash Kick
67. Orch Bass
68. Earth Kick
69. Big Bass Drum
70. Stereo BD
71. Timpani
72. Kettle Drum
73. Kettle Drum 2
74. Jazz Kick
75. Dry Snare
76. Dry Rim
77. Dry Click 1
78. Dry Click 2
79. Arid Snare
80. Brush Snare A
81. Brush Snare B
82. Brush Snare C
83. Snap Snare 1
84. Snap Snare 2
85. Snap Snare 3
86. Snap Snare 4
87. Snap Snare 5
88. Snap Snare 6

PROCUSSION FACTORY STACKS

- | | | | |
|------|----------------|------|------------------|
| 89. | Brush Sweep | 129. | HerboSnare |
| 90. | Room Snare 1 | 130. | Kooky Snare |
| 91. | Room Snare 2 | 131. | Tough Snare |
| 92. | Stereo Snare | 132. | Snare Smash |
| 93. | Big Snare | 133. | Pipe Snare |
| 94. | Body Snare | 134. | Sewer Snare |
| 95. | God's Snare | 135. | Ringer |
| 96. | Tight Snare | 136. | Ratt Dance |
| 97. | Big Whack | 137. | Canon Snare 1 |
| 98. | Smack Snare | 138. | Canon Snare 2 |
| 99. | Modern Snare | 139. | Canon Snare 3 |
| 100. | Tonal Snare | 140. | Dance Snare |
| 101. | Bonzo Snare | 141. | Analog Snare |
| 102. | Dan's Snare | 142. | Synth Snare |
| 103. | Tite Snare | 143. | House Snare 1 |
| 104. | Slap Snare | 144. | House Snare 2 |
| 105. | Modern Twin | 145. | House Snare 3 |
| 106. | Snare Center | 146. | House Snare 4 |
| 107. | Space Snare | 147. | House Snare 5 |
| 108. | Aerobic Snare | 148. | House Snare 6 |
| 109. | Big Fat Snare | 149. | PW Snarey |
| 110. | Wet Snare 1 | 150. | Rapper Snare |
| 111. | Wet Snare 2 | 151. | Tambo Snare |
| 112. | Wet Snare 3 | 152. | Deep Tam Snare |
| 113. | Wet Snare 4 | 153. | Garbage Boy |
| 114. | Ambient Snare | 154. | Trash Snare 1 |
| 115. | Ambi-Snare 1 | 155. | Trash Snare 2 |
| 116. | Ambi-Snare 2 | 156. | Trash Snare 3 |
| 117. | Krakatoa! | 157. | Trash Snare 4 |
| 118. | Mod Verb Snare | 158. | Bullet Snare |
| 119. | Mod Verb Rim | 159. | Brush Dance |
| 120. | Mod Pan Snare | 160. | Rim Tin Tin |
| 121. | ReverbaRim | 161. | Vel-XSnare |
| 122. | Rim Snare | 162. | Tam Snare 1 |
| 123. | Metal Snare | 163. | Tam Snare 2 |
| 124. | Prairie Snare | 164. | Clave Snare |
| 125. | SNARE 1157 | 165. | Clap Snare |
| 126. | SNARE AMB! | 166. | Backward Snare 1 |
| 127. | Noisy SNR | 167. | Backward Snare 2 |
| 128. | BigOSnare | 168. | Backward Snare 3 |

PROCUSSION FACTORY STACKS

- | | | | |
|------|------------------|------|------------------|
| 169. | Backward Snare 4 | 209. | Tuned Tomz |
| 170. | Rev Snare 1 | 210. | Analog Toms |
| 171. | Rev Snare 2 | 211. | Roto Dance |
| 172. | Rev Snare 3 | 212. | Roto 2 |
| 173. | Center Reverse | 213. | Minor Tom |
| 174. | Bband Snare | 214. | Apache |
| 175. | Bband Rim | 215. | Tacky Bang |
| 176. | Bband Click | 216. | Pots & Pans |
| 177. | Psyko Snare | 217. | Stereo Tom |
| 178. | Swept Snare | 218. | Bband Tom |
| 179. | Dry 12" Tom | 219. | Wunder Tom |
| 180. | Dry 16" Tom | 220. | Echo Tom |
| 181. | Brushed Tom | 221. | Pitch Toms |
| 182. | Punch Tom | 222. | Syn-Tom |
| 183. | Sloppy Toms | 223. | AcousRoto 1 |
| 184. | 2 Head Tom | 224. | ElecTomic |
| 185. | Tim & Tom | 225. | Echo Tom X |
| 186. | Tuned Tom | 226. | Falling Tom |
| 187. | Rock Tom X | 227. | Backward Tom |
| 188. | Room Tom 1 | 228. | Mod Tom Fall |
| 189. | Room Tom 2 | 229. | Mod Wund Tom |
| 190. | Electro Tom | 230. | Mod Brush Tom |
| 191. | SubaTomic | 231. | Mod Echo Tom |
| 192. | Ambi Tom 1 | 232. | Hihat A shut |
| 193. | Ambi Tom 2 | 233. | Hihat A 1/3 |
| 194. | Power Toms | 234. | Hihat A 2/3 |
| 195. | Power Tom 1 | 235. | Hihat A open |
| 196. | Power Tom 2 | 236. | Hihat A stomp |
| 197. | Power Tom 3 | 237. | Hihat B shut |
| 198. | Power Tom 4 | 238. | Hihat B 1/3 |
| 199. | Real Tom | 239. | Hihat B 2/3 |
| 200. | Epic Tom | 240. | Hihat B open |
| 201. | ResonanTom | 241. | Hihat B stomp |
| 202. | EleckTom | 242. | Mod Hihat 1 |
| 203. | Tom Stack X | 243. | Mod Hihat 2 |
| 204. | dB Toms | 244. | Closed Tip Hat A |
| 205. | Tom Hall | 245. | Open Hihat A |
| 206. | Tommy Toon | 246. | Open Hihat B |
| 207. | Homie Tom | 247. | Closed Tip Hat B |
| 208. | House Toms | 248. | 1/2 Open Hat B |

PROCUSSION FACTORY STACKS

- | | | | |
|------|--------------|------|-----------------|
| 249. | Pedal Hat B | 289. | 19" Pang |
| 250. | Metal Hat 1 | 290. | Ride Ping |
| 251. | Metal Hat 2 | 291. | Ride Bell |
| 252. | Metal Hat 3 | 292. | Mallet Cymbal |
| 253. | Syn Hat 1 | 293. | China Gong |
| 254. | Syn Hat 2 | 294. | Mallet Roll |
| 255. | Synth Hat A | 295. | Combo Crash |
| 256. | Synth Hat B | 296. | Dubl Crash |
| 257. | Elec Hat 1 | 297. | Cymbal Decay |
| 258. | Elec Hat 2 | 298. | HypeRidCym |
| 259. | Elec Hat 3 | 299. | Pang Cymbal |
| 260. | Elec Hat 4 | 300. | Big Crash |
| 261. | Dance Hat 1 | 301. | Velocity Ride |
| 262. | Dance Hat 2 | 302. | Dark Cymbal 1 |
| 263. | House Hat 1 | 303. | Dark Cymbal 2 |
| 264. | House Hat 2 | 304. | House Cymbal |
| 265. | House Hat 3 | 305. | Crash Dance |
| 266. | House Hat 4 | 306. | Splash Dance |
| 267. | House Hat 5 | 307. | SoChokeMe |
| 268. | House Hat 6 | 308. | Finger Cymbal |
| 269. | Tam Hat | 309. | Gongo'Doom |
| 270. | Beasty Hat | 310. | Cymbal Six |
| 271. | Beasty Open | 311. | SFX 1 |
| 272. | Horny Hat | 312. | SFX 2 |
| 273. | Blasty Hat | 313. | SFX 3 |
| 274. | Noise Hat A | 314. | Smash Cymbal |
| 275. | Noise Hat B | 315. | Brash Cymbal |
| 276. | Noise Hat C | 316. | SteroCrash |
| 277. | Hatsoff | 317. | Stereo Malt |
| 278. | Hats Off 2U | 318. | Hypereal |
| 279. | Bband Hat Cl | 319. | Backward Cymbal |
| 280. | Bband Hat Op | 320. | Backward Cym |
| 281. | Bband Hat St | 321. | Noise Burst |
| 282. | Servo Hat #1 | 322. | Big Thwack |
| 283. | Servo Hat #2 | 323. | White Noise |
| 284. | Servo Hat #3 | 324. | Big Rasp |
| 285. | Backward Hat | 325. | Big Hammer |
| 286. | 16" Crash 1 | 326. | Metal Stack |
| 287. | 16" Choke 1 | 327. | Stilieto |
| 288. | 16" Crash 2 | 328. | Stilieto Flange |

PROCUSSION FACTORY STACKS

- | | | | |
|------|------------------|------|--------------------|
| 329. | Pipe | 369. | Cowbell |
| 330. | Clank | 370. | Cow Block |
| 331. | Lazer Hit | 371. | Ambi-Stick |
| 332. | Sonic Crack | 372. | Bband Cowbell |
| 333. | Rap Scratch | 373. | Cowtombell |
| 334. | Doubl Scratch 1 | 374. | Stereo Marimba |
| 335. | Double Scratch 2 | 375. | Syn Celesta |
| 336. | Syn Scratch | 376. | Carillon |
| 337. | ErsatScrch | 377. | Log Drum |
| 338. | BASScratch | 378. | Vibrations |
| 339. | Squea... | 379. | Shakatam |
| 340. | Finger Snap | 380. | Synclaves |
| 341. | RevSnapper | 381. | Plastic Cow |
| 342. | Reverb Snaps | 382. | Octarimba |
| 343. | Hand Claps | 383. | Mambo Open |
| 344. | Fat Claps | 384. | Mambo Closed |
| 345. | Odd Claps | 385. | Campana Open |
| 346. | Wack Claps | 386. | Campana Heel |
| 347. | Klapz | 387. | ChaCha Open |
| 348. | RapClav | 388. | ChaCha Closed |
| 349. | Vox Eek!! | 389. | Cabasa Front |
| 350. | Backward Sweep | 390. | Cabasa Back |
| 351. | Hand Drum | 391. | Cabasa Roll |
| 352. | Analog Tick | 392. | Guiro Down |
| 353. | Kick Cymbal | 393. | Guiro Up |
| 354. | Choke-Pipe | 394. | Shekere Net |
| 355. | Choke Clank | 395. | Shekere Snap |
| 356. | Castapan | 396. | Shaker Back |
| 357. | Tick Tock | 397. | Shaker Front |
| 358. | Thwack Echo | 398. | Timbale 1a |
| 359. | Raspiness | 399. | Timbale 1b |
| 360. | Temple Block | 400. | Timbale 1c |
| 361. | Agogo Bell | 401. | Timbale 2a |
| 362. | Triangle | 402. | Timbale 2b |
| 363. | Triangle Mute | 403. | Timbale 2c |
| 364. | Hi Triangle | 404. | Tumba Tone |
| 365. | Clave | 405. | Tumba Rim |
| 366. | Castanet | 406. | Quinto Tone |
| 367. | Wood Block | 407. | Quinto Slap Open |
| 368. | Tamborine | 408. | Quinto Slap Closed |

PROCUSSION FACTORY STACKS

- | | | | |
|------|-----------------|------|----------------|
| 409. | Quinto Tip | 449. | Vox Freak 1 |
| 410. | Quinto Heel | 450. | Vox Freak 2 |
| 411. | Hembra Tone | 451. | Synth Lead |
| 412. | Hembra Slap | 452. | Metalimba |
| 413. | Macho Tip Left | 453. | Red Sky |
| 414. | Macho Tip Right | 454. | Jungle Night |
| 415. | Macho Rim | 455. | Kalimdrum |
| 416. | Macho Tone | 456. | Pit o Doom |
| 417. | Macho Slap | 457. | Shaker Drum 2 |
| 418. | Slide Conga | 458. | Silvoon |
| 419. | Shake It | 459. | Big Al |
| 420. | Conga Set | 460. | Woodpecker |
| 421. | Indo Steel | 461. | Ganga Log |
| 422. | Bongo! Boy! | 462. | Pipeline |
| 423. | Tone Drum | 463. | Springz |
| 424. | Velocity Guiro | 464. | Melodic Bel |
| 425. | Bass 1 | 465. | Shaker Bell 1 |
| 426. | Balzy Bass | 466. | Shaker Bell 2 |
| 427. | Synth Bass | 467. | Mutant Mal 1 |
| 428. | Lazer Bass | 468. | Mutant Mal 2 |
| 429. | Bass Stack | 469. | Backward Agogo |
| 430. | Mod Bass Tone | 470. | Big Pipe |
| 431. | Mod Woof Tone | 471. | Marimboid |
| 432. | Mod Saw Tone | 472. | House Pipe |
| 433. | Mod Pipe Tone | 473. | Weird O Slap |
| 434. | Monsta Bass | 474. | Tinkle Tine |
| 435. | Hip Moog | 475. | Bellhause |
| 436. | Rap Moog | 476. | Golden Gate |
| 437. | Warm Bass | 477. | Mod Shots |
| 438. | Stone Bone | 478. | Surfin' USA |
| 439. | Amazon | 479. | Velocity Sweep |
| 440. | Hallowell | 480. | Metl Ketl |
| 441. | Star Tree | 481. | Klincker |
| 442. | Thundadome | 482. | Crackssss! |
| 443. | ShakerDrum | 483. | Space Stone |
| 444. | Drumborine | 484. | Fantasy 99 |
| 445. | Gutt Bust | 485. | Zapster |
| 446. | Dust Pang | 486. | Cymbaline |
| 447. | Warble Wave | 487. | Mega Garbo |
| 448. | Temple Bell | 488. | BAM BAM |

PROCUSSION FACTORY STACKS

- | | | | |
|------|------------------|------|---------------|
| 489. | Super Spring | 529. | Pipegg Right |
| 490. | Tone Drum 2 | 530. | Rocket #1 |
| 491. | Industry | 531. | Rocket #2 |
| 492. | Master Blast | 532. | Tweek |
| 493. | Ice Missile | 533. | Ear Splitter |
| 494. | Fire Biter | 534. | Space Block |
| 495. | DUNK | 535. | Cool FX |
| 496. | Klinkle | 536. | Qool KlanQ |
| 497. | Pipertam | 537. | Stick/Tamb |
| 498. | Bellism | 538. | The Shaker |
| 499. | Jangler | 539. | The Stick |
| 500. | Double Drum | 540. | Twank |
| 501. | Mystic Land | 541. | Mega Planks |
| 502. | Macho Cow | 542. | Temple O Doom |
| 503. | Inner Val | 543. | Glong |
| 504. | Fibersnap | 544. | Giant Ratchet |
| 505. | Whole Tone 1 | 545. | Echo Thud |
| 506. | Whole Tone 2 | 546. | Awk Bosk |
| 507. | Gong Pow | 547. | Gymnasium |
| 508. | Ritual Drum | 548. | Klicker |
| 509. | Cymbal Drum | 549. | Der Aufish |
| 510. | Springy | 550. | Bubl Trubl |
| 511. | Baby Breath | 551. | FunkinNoys |
| 512. | Bent China | 552. | Lazer Stew |
| 513. | Ant Itch | 553. | Kloggers |
| 514. | Water Pin | 554. | Rasparity |
| 515. | Sigh... | 555. | Drum Tree |
| 516. | Indian Man | 556. | They're Here |
| 517. | Hat Thang | | |
| 518. | Thwack | | |
| 519. | Crack | | |
| 520. | CirckeNoys | | |
| 521. | Gong Attack | | |
| 522. | UFOs | | |
| 523. | Cheering | | |
| 524. | Generator X | | |
| 525. | Noise FX | | |
| 526. | Snare Pegg Left | | |
| 527. | Snare Pegg Right | | |
| 528. | Pipegg Left | | |

PROCUSSION INSTRUMENTS

SAMPLED SOUNDS

1. Dry Kick 1
2. Dry Kick 2
3. Dry Kick 3
4. Room Kick 1
5. Room Kick 2
6. Wet Kick 1
7. Wet Kick 2
8. Wet Kick 3
9. Machine K1
10. Machine K2
11. Rap Kick
12. Orch Bass
13. Dry Snare 1
14. Dry Snare 2
15. Dry Snare 3
16. Dry Rim 3
17. Dry Click 3
18. Dry Click 4
19. Dry Snare 5
20. Dry Snare 6
21. Dry Snare 7
22. Dry Snare 8a
23. Dry Snare 8b
24. Dry Snare 8c
25. Wet Snare 1
26. Wet Snare 2
27. Wet Snare 3
28. Wet Snare 4
29. Wet Snare 5
30. Wet Snare 6
31. Snap'n Snare
32. Dance Snare
33. Analog Snare
34. Synth Snare
35. Brush Snare A
36. Brush Snare B
37. Brush Snare C
38. Brush Sweep
39. Dry 12" Tom
40. Dry 16" Tom
41. Room Tom 1
42. Room Tom 2
43. Brushed Tom
44. Electro Tom
45. Hi-Hat A shut
46. Hi-Hat A 1/3
47. Hi-Hat A 2/3
48. Hi-Hat A open
49. Hi-Hat A stomp
50. Hi-Hat B shut
51. Hi-Hat B 1/3
52. Hi-Hat B 2/3
53. Hi-Hat B open
54. Hi-Hat B stomp
55. Mallet Roll
56. 16" Crash 1
57. 16" Choke 1
58. 16" Crash 2
59. 19" Pang
60. Ride Ping
61. Ride Bell
62. Springy
63. Cowbell
64. Side Stick
65. Tambourine
66. Finger Snap
67. Hand Claps
68. Noise Hat A
69. Noise Hat B
70. Noise Hat C

PROCUSSION INSTRUMENTS

- | | |
|--------------------|-------------------------|
| 71. Noise Burst | 106. Shekere Net |
| 72. Big Thwack | 107. Shekere Snap |
| 73. White Noise | 108. Shaker Back |
| 74. Big Rasp | 109. Shaker Front |
| 75. Big Hammer | 110. Timbale 1a |
| 76. Metal Stack | 111. Timbale 1b |
| 77. Stiletto | 112. Timbale 1c |
| 78. Pipe | 113. Timbale 2a |
| 79. Clank | 114. Timbale 2b |
| 80. Lazer Hit | 115. Timbale 2c |
| 81. Sonic Crack | 116. Tumba Tone |
| 82. Rap Scratch 1 | 117. Tumba Rim |
| 83. Rap Scratch 2 | 118. Quinto Tone |
| 84. Syn Scratch | 119. Quinto Slap Open |
| 85. Hand Drum | 120. Quinto Slap Closed |
| 86. Analog Tick | 121. Quinto Tip |
| 87. Vox Eek ! | 122. Quinto Heel |
| 88. HypeRideCym | 123. Hembra Tone |
| 89. Temple Block | 124. Hembra Slap |
| 90. Agogo Bell | 125. Macho Tip L |
| 91. Triangle | 126. Macho Tip R |
| 92. Triangle Mute | 127. Macho Rim |
| 93. Mambo Open | 128. Macho Tone |
| 94. Mambo Closed | 129. Macho Slap |
| 95. Campana Open | 130. Marimba |
| 96. Campana Heel | 131. Celeste |
| 97. Cha Cha Open | 132. Kick Space |
| 98. Cha Cha Closed | 133. DarkK-Space |
| 99. Cabasa Front | 134. Snare Space |
| 100. Cabasa Back | 135. DarkSnSpace |
| 101. Cabasa Roll | 136. Synth Bass |
| 102. Wood Block | 137. SE Bass |
| 103. Claves | 138. Filter Bass |
| 104. Guiro Down | 139. Saw Bass |
| 105. Guiro Up | 140. Woofer Pulse |

PROCUSSION INSTRUMENTS

CLASSIC WAVEFORMS

- 141. Sine Wave
- 142. Triangle Wave
- 143. Square Wave
- 144. Sawtooth

HARMONIC WAVEFORMS

145. Oct 1 (Sine)

146. Oct 2 All

147. Oct 3 All

148. Oct 4 All

149. Oct 5 All

150. Oct 6 All

151. Oct 7 All

152. Oct 2 Odd

153. Oct 3 Odd

154. Oct 4 Odd

155. Oct 5 Odd

156. Oct 6 Odd

157. Oct 7 Odd

158. Oct 2 Even

159. Oct 3 Even

160. Oct 4 Even

161. Oct 5 Even

162. Oct 6 Even

163. Oct 7 Even

164. Low Odds

165. Low Evens

166. Four Octaves

Starting from the first octave (fundamental), the harmonic waveforms contain the harmonics (odd, even, or all) present in each octave. In each successive octave the number of harmonics doubles. By combining (layers 1-4) the harmonic waveforms in various amounts (volume), and transposing them (coarse/fine tuning), a broad range of timbres may be produced.

The harmonic waveforms can also be combined with the sampled instruments to accent certain harmonics or to create synthesized types of sounds.

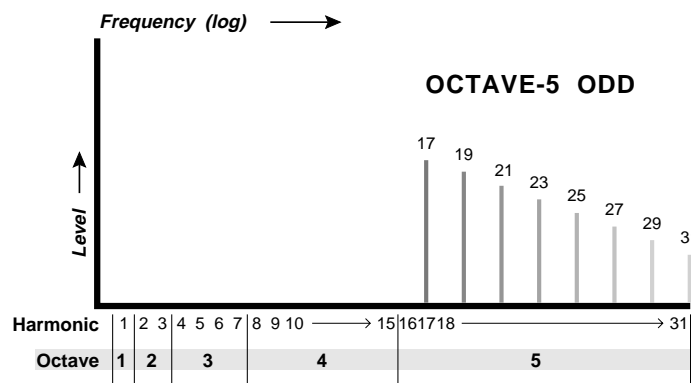

As an example, this chart shows the harmonics present in the **Octave 5 Odd** waveform.

PROCUSSION INSTRUMENTS

DIGITAL WAVEFORMS

- 167. Pulse 33%
- 168. Pulse 25%
- 169. Pulse 10%
- 170. Saw Odd Gone
- 171. Ramp
- 172. Ramp Even Only
- 173. Buzzoon
- 174. Brassy Wave
- 175. Reedy Buzz
- 176. Growl Wave
- 177. Harpsiwave
- 178. Fuzzy Gruzz
- 179. Power 5ths
- 180. Filter Saw
- 181. Moog Lead
- 182. Synth Cycle 1
- 183. Synth Cycle 2
- 184. Synth Cycle 3
- 185. Bite Cycle
- 186. Buzzy Wave
- 187. Metalphone 1
- 188. Metalphone 2
- 189. Metalphone 3
- 190. Duck Cycle 1
- 191. Duck Cycle 2
- 192. Wind Cycle 1
- 193. Wind Cycle 2
- 194. Wind Cycle 3
- 195. Wind Cycle 4
- 196. Organ Cycle
- 197. Soft Bell
- 198. Swirly
- 199. Tack Attack
- 200. Shimmer Wave
- 201. B3 SE
- 202. Mild Tone
- 203. Piper
- 204. Ah Wave
- 205. Vocal Wave
- 206. Fuzzy Clav
- 207. Electrhode
- 208. Whine 1
- 209. Whine 2
- 210. Metal Drone
- 211. Silver Race
- 212. Metal Attack
- 213. Ice Bell
- 214. Bronze Age
- 215. Iron Plate
- 216. Aluminum
- 217. Lead Beam
- 218. Steel Extract
- 219. Winter Glass
- 220. Town Bell Wash

LFO, DELAY and ENVELOPE TIMES

ATTACK

Knob	Time (sec)
0	0
3	.032
5	.11
10	.26
15	.47
20	.7
30	1.76
40	2.75
50	4.5
63	10

DELAY

Knob	Time (sec)
0	0
3	.015
5	.02
10	.07
20	.17
30	.31
40	.53
50	.85
63	1.46

HOLD

Knob	Time (sec)
0	0
3	.015
5	.07
10	.17
15	.31
20	.53
30	1.34
40	3.14
50	7.17
63	20.63

LFO RATES

Knob	Rate (Hz)
0	.089
3	.13
5	.42
10	.85
15	1.34
20	2
25	2.6
30	3.4
40	5.43
50	8.22
63	13.45

DECAY

Knob	Time (sec)
0	0
3	.015
5	.07
10	.17
15	.31
20	.53
30	1.34
40	3.14
50	7.17
63	20.63

PITCH ENV. DECAY

Knob	Time (sec)
0	0
3	.03
5	.1
10	.23
15	.42
20	.72
30	2
40	6.2
50	17.8
63	63.2

PITCH MODULATION INTERVAL CHARTS

■ These charts may prove helpful when modulating pitch. Setting the amounts as shown, will produce the indicated intervals.

Positive Stack Modulation

Amount	Interval
+8	minor 2nd
+16	major 2nd
+24	minor 3rd
+32	major 3rd
+40	perfect 4th
+49	minor 5th
+57	perfect 5th
+65	minor 6th
+73	major 6th
+81	minor 7th
+89	minor 9th
+97	major 9th
+105	octave
+113	minor 10th
+121	major 10th

When Pitch Wheel is used as the controller, **Double** the Modulation Amounts shown.

Negative Stack Modulation

Amount	Interval
-8	minor 2nd
-16	major 2nd
-24	minor 3rd
-32	major 3rd
-40	perfect 4th
-48	minor 5th
-56	perfect 5th
-64	minor 6th
-72	major 6th
-80	minor 7th
-88	minor 9th
-96	major 9th
-104	octave
-113	minor 10th
-121	major 10th

Positive LFO

Amount	Interval
+16	minor 2nd
+33	major 2nd
+49	minor 3rd
+65	major 3rd
+81	perfect 4th
+97	minor 5th
+113	perfect 5th

Negative LFO

Amount	Interval
-16	minor 2nd
-32	major 2nd
-48	minor 3rd
-64	major 3rd
-80	perfect 4th
-96	minor 5th
-112	perfect 5th
-128	minor 6th

Pitch Envelope

Amount	Interval
±8	minor 2nd
±16	major 2nd
±24	minor 3rd
±32	major 3rd
±40	perfect 4th
±48	minor 5th
±56	perfect 5th
±64	minor 6th
±72	major 6th
±80	minor 7th
±88	minor 9th
±96	major 9th
±104	octave
±112	minor 10th
±120	major 10th
Etc. up to ±256	

ZONE MAP CHART

There are four different factory zone maps resident in ROM. The chart below shows how the Zone Maps translate MIDI key numbers to Zones.

Alesis.....	Standard
drumKat	Standard
E-mu SP-12	SP-12
Aphex Impulse.....	Standard
Roland Octapad I.....	Roland
Roland Octapad II.....	Roland
Roland Pad 80	Roland
Roland SPD8.....	Roland
Roland R5 / R8.....	Roland

▼ Always check the Zone Map if zones seem to disappear or are not being correctly assigned.

ZONE MAP CHART

Sound	Zone	Standard Key #	Roland Key #	SP-12 Key #	Default Key #
Kick	1	36	35	36	36
Kick	2	52	36	38	38
Snare	3	38	38	40,41	40
Snare	4	53	40	39	41
Snare	5	57	60	43	43
Snare	6	74	65	45	45
Hi-Hat	7	42	42	42	47
Hi-Hat	8	44	44	44	48
Hi-Hat	9	54	46	46	50
Hi-Hat	10	56	75	37	52
Tom	11	40, 41	41	47	53
Tom	12	43	43	48	55
Tom	13	45	45	50	57
Tom	14	47, 48	47,48	52	59
Cymbal	15	49	49	56	60
Cymbal	16	50	50	58	62
Cymbal	17	51	51	54	64
Cymbal	18	65	53	60-67	65
Claps	19	37	39	49	67
Misc. Perc.	20	39	54	59	69
Misc. Perc.	21	46	56	57	71
Misc. Perc.	22	58	68	53	72
Misc. Perc.	23	59	69	55	74
Misc. Perc.	24	60	71	51	76

▼ Do not confuse the Standard Zone Map with the Standard Factory Kit Layout.

■ In the Default Zone Map, the 24 zones fall on consecutive white keys starting at key number 36.

TECHNICAL SPECIFICATIONS

Audio Channels: 32

Audio Outputs: 6

Submix Inputs: 4

Max. Output Level: +4 dB into 600 Ω

Output Impedance: 100 Ω

MIDI: In, Out, Thru

Data Encoding: 16 bit Linear

Sample Playback Rate: 39kHz

Signal to Noise: >90 dB

Dynamic Range: >90 dB

Frequency Response: 20Hz-18kHz

THD +N: <.05%

IMD: <.05%

Power Requirements: 25 Watts

Operating Temperature: 110° F Max.

Dimensions: H: 1.75" W: 19" L: 8.5"

Weight: 4 lb, 7 oz (2 Kg)

MIDI SPECIFICATIONS

RECEIVED CHANNEL COMMANDS

Channels number (n) = 0-15. Message bytes are represented in hex. All other numbers are decimal.

Command	Message	Comments
Note Off	8n kk vv	release velocity is ignored
Note On	9n kk vv	velocity 0 = note off
Program Change	Cn pp	
Channel Pressure	Dn pp	
Pitch Wheel	En ll mm	l = lsb, m = msb
Realtime Controller	Bn cc vv	cc = 00-31
Footswitch	Bn cc vv	cc = 64-79, vv ≥ 64 = on
Volume	Bn 07 vv	
Pan	Bn 0A vv	0 = hard left, 127 = hard right
Reset All Controllers	Bn 79 00	ignored in omni mode
All Notes Off	Bn 7B 00	ignored in omni mode
Omni Mode	Bn 7D 00	forces all notes & controls off
Mono Mode	Bn 7E 00	forces all notes & controls off
Poly Mode	Bn 7F 00	forces all notes & controls off

MIDI SPECIFICATIONS

■ Two MIDI bytes (lsb, msb) are required for each 14 bit data word. Bits 0-6 are sent first, followed by bits 7-13 in the next MIDI byte. All data words are signed 2's complement values with sign-extension out to the most significant bit (bit 13). This convention applies to all data words, regardless of the parameter's value range.

RECEIVED SYSTEM COMMANDS

For system exclusive commands, the following format is used:

F0	system exclusive status byte
18	E-mu ID byte
06	product ID byte
dd	device ID byte
cc	command byte
...	data bytes
F7	EOX

Command	Message	Comments
Kit Data Request	F0 18 06 dd 00 ll mm F7 1024 = bank 0 (0-63) 1025 = bank 1 (64-127) 1026 = bank 2, .. thru max bank	ll = kit # lsb, mm = msb
Kit Data	F0 18 06 dd 01 ll mm ... cs F7 cs = checksum = sum of all data bytes	
Parameter Value Req.	F0 18 06 dd 02 pl pm F7 pl = parameter # lsb, pm = msb	
Parameter Value	F0 18 06 dd 03 pl pm vl vm F7 vl = value lsb, vm = msb	
User Zone Map Request	F0 18 06 dd 04 zz F7	zz = map #
User Zone Map Data	F0 18 06 dd 05 zz ... F7	
Program Map Request	F0 18 06 dd 06 F7	
Program Map Data	F0 18 06 dd 07 ... F7	
Master Settings Request	F0 18 06 dd 08 F7	
Master Settings Data	F0 18 06 dd 09 ... F7	
Configuration Request	F0 18 06 dd 0A F7	
List Request	F0 18 06 dd 0C ll F7 ll: 0 = kits, 1 = stacks, 2 = instruments	

MIDI SPECIFICATIONS**TRANSMITTED SYSTEM COMMANDS**

Command	Message	Comments
Kit Data	F0 18 06 dd 01 ll mm ... cs F7	cs = checksum = sum of all data bytes
Parameter Value	F0 18 06 dd 03 pl pm vl vm F7	vl = value lsb, vm = msb
User Zone Map Data	F0 18 06 dd 05 zz ... F7	zz = map #
Program Map Data	F0 18 06 dd 07 ... F7	
Master Settings Data	F0 18 06 dd 09 ... F7	
Configuration	F0 18 06 dd 0B vv r1 r2 r3 kl km sl sm s1 l1 m1 s2 l2 m2 F7	
	vv = version	r1, r2, r3 = revision #
	sl, sm = # of stacks	s1 = sound set 1
		s2 = sound set 2
		kl, km = # of kits
		l1, m1 = # of insts
		l2, m2 = # of insts
List Data	F0 18 06 dd 0D ll F7	ll: 0 = kits, 1 = stacks, 2 = instruments

Note: When sending a bank of kits to Procussion, the host should pause for about 100 milliseconds between each kit message.

MIDI GLOBALS

One group of global parameters determines how the machine will respond to all MIDI commands. These variables are stored in nonvolatile RAM, and can be modified from the front panel or edited with system exclusive commands. The standard MIDI program change, volume, and pan commands can also be used "on the fly" for individual channels.

One of three mutually exclusive modes (omni, poly, multi) is selectable by the user. A MIDI mode change command will turn off all notes and reset all controllers.

MIDI SPECIFICATIONS

PARAMETER EDITING

Parameters may be edited individually using system exclusive commands. The kit being edited is the current kit. The value of a given parameter may be changed by sending a **parameter value** command. The value of a parameter may be read by sending a **parameter value request**, to which the machine will respond by sending back the parameter value command.

Kit data may also be transmitted or received in a single block (one complete kit) using system exclusive commands. A **kit data request** may be issued by a host computer, to which the machine will respond by sending the data block for the requested kit. Conversely, the computer may send new kit data which will replace the specified kit currently in the machine.

DATA DUMPS

The user can send kits and global data via MIDI for backup onto a sequencer or other device. The options are:

- Master settings
- MIDI program/kit map
- User zone maps
- Factory kits
- All user kits
- One kit

PROGRAM/KIT MAP

MIDI program changes will normally correspond to internal kit numbers 0 to 127. However, the user may 're-map' any MIDI program number, assigning it to an arbitrary internal kit. This feature allows any of the internal kits to be selected from a MIDI keyboard controller.

SOUND SETS

A **sound set** consists of 4 Megabytes of sample data (sound ROMs), plus additional instrument data in the program ROMs. Procussion may contain one or two complete sound sets. Each sound set has a unique ID number.

MIDI SPECIFICATIONS

In order to achieve compatibility between different configurations, it is necessary to include the sound set number as part of the instrument number when exchanging data. The instrument number (as expressed over MIDI) contains two fields: bits 9-11 specify the sound set (0-7) and bits 0-8 specify the instrument within the sound set (0-511).

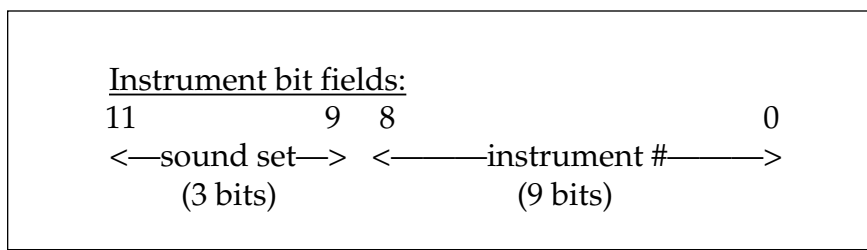

Within any given sound set, the first instrument is #1, and #0 selects “None”. The first version of Procussion will contain sound set #0.

CONFIGURATION MESSAGE

External software may request the machine’s configuration. The **configuration message** consists of the following information:

- version
- software revision string
- number of kits
- number of stacks
- number of instruments in each sound set
- sound set ID numbers

LIST REQUEST

The **list request** allows external software to upload the names of kits, instruments, and stacks as an array of ASCII strings. This allows editor/librarian programs to automatically configure to any future versions of Procussion. Each element in the array is a 13-byte string consisting of 12 ASCII name bytes followed by a null (zero) terminator.

MIDI SPECIFICATIONS

DATA FORMATS

Parameter Changes: All individual parameter changes use signed 14-bit values to represent the parameter number and value. Two MIDI bytes (lsb, msb) are required for each 14-bit data word. Bits 0-6 are sent first, followed by bits 7-13 in the next MIDI byte. All data words are signed 2's complement values with sign-extension out to the most significant bit (bit 13). This convention applies to all data words, regardless of the parameter's value range.

Kits: Kit data is transmitted and received using the following format: The standard system exclusive header (described below) is followed by the kit number (lsb, msb), 1 or 2 bytes for each parameter value (see parameter list), a one-byte checksum, and the end-of-exclusive byte (F7). The checksum is the modulo 128 sum of all the parameter value bytes; that is, all of the data bytes following the kit number and before the checksum.

The kit is transferred in the following sequence:

- general kit parameters
- zone parameters for zone #0, 1, 2 ... 23
- stack parameters for stack #0, 1, 2, ... 7

Within each stack, the sequence is:

- general stack parameters
- layer parameters for layer #0,1,2,3

Refer to the parameter list for the actual ordering within each group.

Master Settings: The master settings are transferred in a group using 1 or 2 bytes for each parameter value. The sequence is as follows:

- global parameters
- MIDI channel parameters for channel #0, 1, 2, ... 15

Program/Kit Map: Each entry in the program/kit map is a 14-bit word in lsb, msb format as described above for parameter changes.

User Zone Map: The user zone map is transmitted as a 7-bit low key and high key for each zone, for a total of 48 MIDI bytes (excluding the sys ex header and EOX).

MIDI SPECIFICATIONS

PARAMETERS

Parameter Number Encoding

Because of the large number and different types of parameters in Procussion, the parameter number is actually a code made up of several "bit fields" which contain different information. Within the 14-bit parameter number, the two most-significant bits (the "T" field) determine the parameter type, and the meaning of the other bits is dependent on the type, as follows:

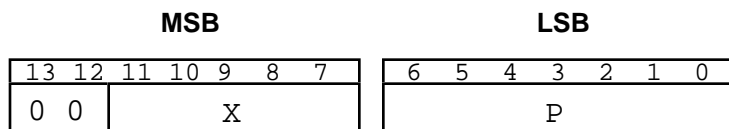

Kit parameter: T = 0
 P = parameter #
 X = don't care

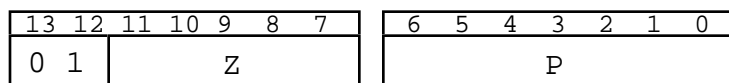

Zone parameter: T = 1
 Z = zone # (0-23)
 P = parameter #

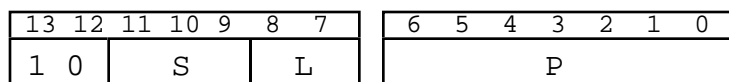

Stack/layer parameter: T = 2
 S = stack # (0-7)
 L = layer # (0-3) if applicable, else don't care
 P = parameter #

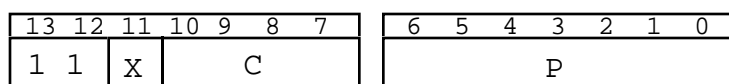

Master parameter: T = 3
 C = MIDI ch. (0-15) if applicable, else don't care
 P = parameter #
 X = don't care

MIDI SPECIFICATIONS

Please note: In the following tables, the “size” specification refers to the number of MIDI bytes used when transferring kit data or master settings as a whole; when sending or reading individual parameter values, two MIDI bytes are always used.

KIT PARAMETERS (T=0)

Parameter #	Parameter Name	Size	Range
P= 0-11	kit name (12 ascii chars)	12	32-127
12	mod source 1	1	0-9
13	mod dest 1	1	0-57
14	mod amount 1	2	-128 to +127
15	mod source 2	1	0-9
16	mod dest 2	1	0-57
17	mod amount 2	2	-128 to +127
18	footswitch dest 1	1	0-39
19	footswitch dest 2	1	0-39
20	trigger tempo	2	0-240
21	velocity curve	1	0-9

ZONE PARAMETERS (T=1)

Parameter #	Parameter Name	Size	Range
P= 0	stack select	2	0- # of stacks
1	low key	1	0-127
2	high key	1	0-127
3	coarse tune	1	-48 to +48
4	fine tune	1	-64 to +63
5	volume	1	0-127
6	pan	1	-8 to +7
7	output	1	0-15
8	assign mode	1	0-13
9	nontranspose	1	0-1
10	enable patch 1	1	0-1
11	enable patch 2	1	0-1
12	enable footswitch 1	1	0-1
13	enable footswitch 2	1	0-1

MIDI SPECIFICATIONS**STACK PARAMETERS****(T=2)**

Parameter #	Parameter Name	Size	Range
P= 0-9	stack name (10 chars)	10	32-127
10	mod source 3	1	0-9
11	mod dest 3	1	0-57
12	mod amount 3	2	-128 to +127
13	mod source 4	1	0-9
14	mod dest 4	1	0-57
15	mod amount 4	2	-128 to +127
16	mod source 5	1	0-9
17	mod dest 5	1	0-57
18	mod amount 5	2	-128 to +127
19	mod source 6	1	0-9
20	mod dest 6	1	0-57
21	mod amount 6	2	-128 to +127
22	footswitch dest 3	1	0-15
23	footswitch dest 4	1	0-15
24	LFO amount	2	-128 to +127
25	LFO shape	1	0-3
26	LFO rate	1	0-63
27	LFO dest	1	0-10
28	switch mode	1	0-7
29	switch group	1	0-1
30	switch source	1	0-10
31	switch point 1	1	0-127
32	switch point 2	1	0-127
33	switch point 3	1	0-127

MIDI SPECIFICATIONS**LAYER PARAMETERS**

Parameter #	Parameter Name	Size	Range
P= 64	layer instrument	2	0- # of insts
65	coarse tune	1	-48 to +48
66	fine tune	1	-64 to +63
67	volume	1	0-127
68	pan	1	-7 to +7
69	reverse	1	0-1
70	delay	1	0-63
71	start offset	2	0-255
72	alt env on/off	1	0-1
73	alt env attack	1	0-63
74	alt env hold	1	0-63
75	alt env decay	1	0-63
76	pitch env on/off	1	0-1
77	pitch env decay	1	0-63
78	pitch env amount	2	-256 to +255

MASTER PARAMETERS**(T=3)**

Parameter #	Parameter Name	Size	Range
P= 0	MIDI basic channel	1	0-15
1	master tune	1	-64 to +63
2	transpose	1	-12 to +12
3	MIDI mode	1	0-2
4	device id number	1	0-15
5	mode change enable	1	0-1
6	volume controller #	1	0-95
7	pan controller #	1	0-95
8-11	controller A-D numbers	4	0-95
12-15	footswitch 1-4 numbers	4	0-95
16	global trigger tempo	2	0-242
17	auto-select	1	0-1
18	remote edit	1	0-1
19	audition layer	*	0-4
32-47	submix output	16	0-8

* This parameter is not included in the "master settings" message.

MIDI SPECIFICATIONS**PER MIDI CHANNEL**

Parameter #	Parameter Name	Size	Range
P= 64	kit select	2	0- max kit #
65	MIDI volume	1	0-127
66	MIDI pan	1	-8 to +7
67	global velocity curve	1	0-10
68	envelope mode	1	0-1
69	MIDI channel enable	1	0-1
70	MIDI prog change enable	1	0-1
71	zone map	1	0-10

SysEx MESSAGE SIZES**Kit Data**

F0 18 06 dd 01 ll mm (1273 data bytes) cs F7 = **1282 bytes total**

User Zone Map

F0 18 06 dd 05 zz (48 data bytes) F7 = **55 bytes total**

Program Map

F0 18 06 dd 07 (256 data bytes) F7 = **262 bytes total**

Master Settings

F0 18 06 dd 09 (180 data bytes) F7 = **186 bytes total**

List Data

F0 18 06 dd 0D ll (13 bytes x # of entries) F7

INDEX**A**

accent 40, 56, 64
 aftertouch *See* pressure
 alternate envelope 62
 See also envelope generator
 alternate switch mode 66
 assignment mode 54
 attack 38, 62
 audition layer 68
 auto select 29

C

connection instructions 7-12
 contour
 See envelope generator
 controls 17
 copy stack 69, 81
 copy zone 68
 crossfade mode 65
 custom stacks 59-68
 cursor 17

D

decay 38, 62, 63
 delay
 instrument delay 61
 time chart 103
 demo sequence 31
 drum pads, connection 7, 10-12

E

edit menu 47
 envelope generator
 alternate envelope 62
 description 32
 mode 26, 38
 pitch envelope 62, 63
 time chart 103
 external processing 11, 13, 21, 46, 55, 88
 exclusive 1-8 mode 54

F

footswitches 12, 28, 37, 57, 65, 67

G

global controls
 global trigger tempo 23, 80
 global velocity curve 22

H

headphones 7
 hi-hat
 pedal connection 12
 switch mode 66
 tutorial 81
 hold 38, 62

I

ID number, MIDI 22
 instrument 6, 41, 50, 60
 instrument list 99-102
 inputs 7, 9, 11-13
 interval charts 104

K

keyboard, setup 8-9
 key range 52
 key velocity 37
 velocity modulation 37, 56, 64
 kit
 description 6, 35, 50
 listing 90-91
 naming 51
 saving 69
 selection 18
 kit change via MIDI 26

L

layer 41, 42, 50, 60, 65-67
 LFO
 definition 39
 programming 63, 64
 time chart 103

M

mapping, kit
 See MIDI program->kit
 master menu 20
 master tune 20
 MIDI
 MIDI channel selection 18
 MIDI enable 26
 MIDI footswitch 28, 37, 56, 57, 65, 67
 MIDI in 7, 9, 11, 12
 MIDI mode 22
 MIDI mode change 27
 MIDI out 9, 30

INDEX**M (cont)**

MIDI panning control 18, 27
MIDI program change 18, 26
MIDI program-> kit 28
MIDI specifications 107-117
MIDI thru 9, 11
MIDI realtime controllers 27, 44, 45
 amounts 56, 64
 modulation assignment 56, 64
controller numbers 27, 45
MIDI system exclusives 108-117
 ID number 22
MIDI volume control 18, 27
mix outputs 7, 9, 11, 13, 21, 46, 55
modulation
 description 36
 enable 55
 footswitch 12, 28, 37, 57, 65, 67
 interval charts 104
 patching 40, 42, 44, 64, 56
 realtime mod. 42, 44, 64, 56
 sources 42, 56, 64
mono assignment mode 54
multi-timbral operation 19, 86

N

nontranspose mode 53

O

omni *See* MIDI mode
outputs, audio 7, 9, 11, 13
 MIDI 9, 30

P

pan 18
 MIDI control of pan 18, 27
 sequencer control of 87
patch 40
pitch *See* tuning
pitch envelope 62, 63
pitch wheel 42, 44-45, 56, 64, 80
poly *See* MIDI mode
 See also assignment mode
power requirements 13, 106
 See also precautions section
pressure 27, 37, 42, 44, 45, 56, 64
Procussion Synthesis 83-85
programming tips 82
programming tutorial 71-88

R

random number controller 56, 64
random switch modes 67
realtime modulation 44, 45, 56, 64
remote edit 29
reverse sound 62

S

sampling, basic description 32
sampled sound listing 99-102
saving
 kits 69, 75
 MIDI data 30
sawtooth wave 39, 63
sequencer
 external sequencer setup 86-87
 Procussion demo sequence 31
 saving kits to 30
sine wave 39, 63
sound start 47, 54, 67, 78, 82
spatial convolution 85
specifications
 MIDI 107-117
 technical 106
split keyboard 6, 35, 50, 52
square wave 39, 63
stack
 custom stacks 42, 50, 59-68
 copy stack 69
 description 6, 42, 50
 factory stack listing 92-98
 programming tutorial 71-88
 stack footswitch 65
 stack instrument 60
 stack modulation 64
 stack name 59
 stack pan 60, 77
 stack select 52, 76
 stack tune 60, 76
 stack volume 60, 77
submix
 inputs/outputs 7, 9, 13
 programming 23, 46, 55
 send/return cables 11, 13
sustain 26, 38, 62
switch group 67
switch mode 65-67
switch source 67
switch points 68

INDEX**T**

threshold switch mode 66
tone 42, 56, 64
transpose 21
triangle wave 39, 63
triggering, footswitch 57
trigger mode 26, 38
trigger tempo 25, 59, 80
tuning
 master tune 20
 instrument tuning 60
 tuning zones 52, 74

U

user zone maps 24, 25
 assignment chart 25

V

velocity curves
 global 22
 description 43
 kit curves 57, 58
viewing angle 30
volume
 volume control 17
 channel volume 18
 MIDI volume control 18, 27
 sequencer control of 87
 stack volume 60, 77

W

waveforms
 classic 101
 digital 102
 harmonic 101
 instruments 99-102
 LFO 39, 63

Z

zones
 assignment mode 54
 copy zone 68
 description 6, 35, 50
 zone key range 52
 zone maps 23-25, 105
 zone submix 55
 zone tuning 52, 74
 zone volume 52, 53
 zone pan 52, 53

NOTES

*For future reference, copy the
Serial Number from your Procussion here.*

SERIAL NUMBER

PROCUSSION™
16 bit Percussion Sound Module
Operation Manual
© 1990 E-mu Systems, Inc.
All Rights Reserved

Written and illustrated by
Riley Smith

Cover by Dan Borba

■ FI386 Rev. C

E-mu Systems, Inc.
1600 Green Hills Road
Scotts Valley, CA 95066
(408) 438-1921

*Important Notice: In order to obtain warranty service on your
Procussion, the serial number sticker must be intact and you
must have a sales receipt or other proof of purchase. If there is
no serial number sticker on your Procussion, please contact
E-mu Systems at once.*

This product is covered by one or more of the following
U.S. patents: 3,969,682; 3,986,423; 4,404,529; 4,506,579;
4,699,038; and foreign patents and/or pending patents.
PROCUSSION is a registered trademark of
E-mu Systems, Inc.

WARNING: READ THIS FIRST!

IMPORTANT SAFETY INSTRUCTIONS

Use in countries other than the U.S.A. may require the use of a different line cord or attachment plug, or both. To reduce the risk of fire or electric shock, refer servicing to qualified service personnel. To reduce risk of fire or electric shock do not expose this product to rain or moisture.

GROUNDING INSTRUCTIONS

This product must be grounded. If it should malfunction or break down, grounding provides a path of least resistance for electric current, reducing the risk of electric shock. This product is equipped with a cord having an equipment-grounding conductor and a grounding plug. The plug must be plugged into an appropriate outlet properly installed and grounded in accordance with all local codes and ordinances.

DANGER

Improper connection of equipment grounding conductor can result in the risk of electric shock. Check with a qualified electrician or service personnel if you are in doubt as to whether the product is properly grounded. Do not modify the plug provided with this product — if it will not fit the outlet, have a proper outlet installed by a qualified technician.

CAUTION

If the 9020, Procussion is rack mounted, a standard 19 inch open frame rack must be used.

USER-MAINTENANCE INSTRUCTIONS

1. The Procussion should be kept clean and dust free. Periodically wipe the unit with a clean, lint free cloth. Do not use solvents or cleaners.
2. There are no user lubrication or adjustment requirements.
3. Refer all other servicing to qualified service personnel.

INSTRUCTIONS PERTAINING TO A RISK OF FIRE, ELECTRIC SHOCK, OR INJURY TO PERSONS

WARNING; When using electric products, basic precautions should always be followed, including the following:

1. Read all instructions before using the Procussion.
2. To reduce the risk of injury, close supervision is necessary when the Procussion is used near children.
3. Do not use the Procussion near water — for example near a bathtub, washbowl, kitchen sink, in a wet basement, on a wet bar, or near or in a swimming pool.
4. The Procussion should be situated so that its location or position does not interfere with its proper ventilation.
5. The Procussion should be located away from heat sources such as radiators, heat registers, fireplaces, stoves, or ovens.
6. The Procussion should only be connected to a power supply of the type described in the operating instructions and as marked on the product.
7. This product, in combination with an amplifier and headphones and speakers, may be capable of producing sound levels that could cause permanent hearing loss. Do not operate for a long period of time at a high volume level or at a level that is uncomfortable. If you experience any hearing loss or ringing in the ears, consult an audiologist.



■ This symbol is intended to alert the user to the presence of important operating and maintenance (servicing) instructions in the literature accompanying the appliance.

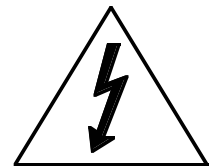

■ This symbol is intended to alert the user to the presence of uninsulated dangerous voltage within the product's enclosure that may be of sufficient magnitude to constitute a risk of electric shock to persons.

8. This Procussion may be equipped with a polarized line plug (one blade wider than the other). This is a safety feature. If you are unable to insert this plug into the outlet, do not defeat the safety purpose of the plug. Contact an electrician to replace your obsolete outlet.
9. The power supply cord of the Procussion should be unplugged from the outlet when left unused for a long period of time.
10. Care should be taken so that objects do not fall and liquids are not spilled into the enclosure of the Procussion through openings.
11. The product should be serviced by qualified service personnel when:
- A. The power supply cord has been damaged; or
 - B. Objects have fallen, or liquid has been spilled into the product; or
 - C. The product has been exposed to rain; or
 - D. The product does not appear to operate normally or exhibits a marked change in performance; or
 - E. The product has been dropped or the enclosure damaged.
12. All servicing should be referred to qualified service personnel.

SAVE THESE INSTRUCTIONS

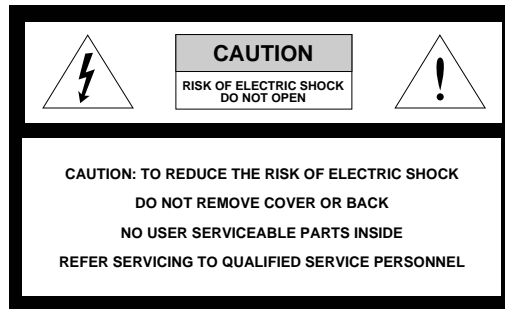

RADIO and TELEVISION INTERFERENCE

The equipment described in this manual generates and uses radio-frequency energy. If it is not installed and used properly-- that is, in strict accordance with our instructions - it may cause interference with radio and television reception.

This equipment has been tested and complies with the limits for a Class A computing device in accordance with the specifications in Subpart J of Part 15 of the FCC rules. These rules are designed to provide reasonable protection against such interference in a residential installation. However, there is no guarantee that the interference will not occur in a particular installation, especially if a "rabbit ear" television antenna is used.

If the Procussion *does* cause interference to radio or television reception, you can try to correct the interference by using one or more of the following measures:

- Turn the television or radio antenna until the interference stops.
- Move the Procussion to one side or the other of the television or radio.
- Move the Procussion farther away from the television or radio.
- Plug the Procussion into an outlet on a different circuit than the television or radio.
- Consider installing a rooftop antenna with a coaxial lead-in between the antenna and television set.